

**Civil Aeronautics Manual 4b**

---

**Airplane Airworthiness;  
Transport Categories**



**FEDERAL AVIATION AGENCY**

---

**September 1962**

Federal Aviation Agency  
Washington, D.C.

Civil Aeronautics Manual 4b

**Airplane Airworthiness; Transport Categories**

---

Supplement No. 1, CAM 4b dated September 1962

Feb. 1, 1963

---

**SUBJECT:** Revisions to CAM 4b

This supplement is issued to incorporate into CAM 4b Civil Air Regulations Amendment 4b-13, and Amendments Nos. 1 and 2 to Special Civil Air Regulation No. SR-422B, and to delete Special Civil Air Regulation No. SR-423 which terminated December 20, 1962.

Amendment No. 1 to Special Civil Air Regulation No. SR-422B concerns three-engine airplanes. It was issued December 10, 1962, and became effective January 15, 1963.

Amendment 4b-13 and Amendment No. 2 to SR-422B concern turboprop conversions of transport category airplanes. They were issued and became effective December 20, 1962.

In the September 1962 revision of CAM 4b, paragraph (b) of section 4b.307 was inadvertently omitted. This error is being corrected by this supplement.

New or revised material is enclosed in black brackets on the pages submitted with this supplement, except the pages in the addendum containing the preambles of amendments. All new pages have been provided for the addendum to correct an error in pagination.

*Remove the following pages:*

XV and XVI  
5 and 6  
89 and 90  
293 through 304  
309 through 313  
P-3 through P-22

*Insert the following new pages:*

XV and XVI  
5 through 6-1  
89 through 90-1  
293 through 304-1  
309 and 310  
P-3 through P-25

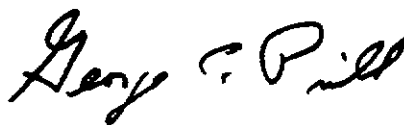

GEORGE C. PEILL, Director,  
Flight Standards Service.

ATTACHMENTS.

## Introductory Note

This manual contains in consolidated form (1) Civil Air Regulations Part 4b, Airplane Airworthiness; Transport Categories, dated December 31, 1953, Amendments 4b-1 through 4b-12, and the editorial changes required by Special Regulation SR-430, effective December 31, 1958; and (2) the rules, policies, and interpretations issued by the Administrator of the Federal Aviation Agency in application to the various sections of the regulations.

FAA *rules* are supplementary regulations. Such rules are mandatory and must be complied with.

FAA *policies* provide detailed technical information on recommended methods of complying with the Civil Air Regulations. Such policies are for the guidance of the public and are not mandatory in nature.

FAA *interpretations* define or explain words and phrases of the Civil Air Regulations. Such interpretations are for the guidance of the public and will be followed by the Agency in determining compliance with the regulations.

With the discontinuance of the distribution of individual amendments of the Civil Air Regulations, it is believed that the preamble material contained in the amendments should be reproduced in the manuals. Therefore, the preambles of Amendments to Part 4b, beginning with Amendment 4b-1 adopted April 13, 1954, are included as an addendum to this manual. In addition to the preamble, the date of adoption, the effective date, Federal Register citation, and the sections affected are given for each amendment.

This manual supersedes Civil Aeronautics Manual 4b dated May 1, 1960, and all supplements thereto. As amendments and other pertinent materials pertaining to Part 4b are issued, they will be included in this manual.

As a convenience to the users of this manual, the changes made by Amendment 4b-12, which was adopted as a result of the First Federal Aviation Agency Airworthiness Review and which became effective May 3, 1962, are enclosed in black brackets.

# Contents

## Subpart A—General

### Applicability and Definitions

	Section	Page
Applicability of this part.....	4b.0	1
Definitions.....	4b.1	1

### Certification

Eligibility for type certificates.....	4b.10	5
Approval of reverse thrust propellers ( <i>FAA policies which apply to sec. 4b.10</i> ).....	4b.10-1	5
Approval of automatic propeller feathering installations ( <i>FAA policies which apply to sec. 4b.10</i> ).....	4b.10-2	5
Minimum quantity of antidetonant fluid required ( <i>FAA policies which apply to sec. 4b.10</i> ).....	4b.10-3	5
Designation of applicable regulations.....	4b.11	5
Recording of applicable regulations.....	4b.12	6
Type certificate.....	4b.13	6
Data required.....	4b.14	7
Inspections and tests.....	4b.15	7
Flight tests.....	4b.16	7
Applicant's flight test report ( <i>FAA policies which apply to sec. 4b.16</i> ).....	4b.16-1	7
Preflight test planning ( <i>FAA policies which apply to sec. 4b.16 (a)</i> ).....	4b.16-2	7
Additional flight tests ( <i>FAA policies which apply to sec. 4b.16 (b)</i> ).....	4b.16-3	9
Flight tests ( <i>FAA policies which apply to sec. 4b.16</i> ).....	4b.16-4	11
Airworthiness, experimental, and production certificates.....	4b.17	11
Approval of materials, parts, processes, and appliances.....	4b.18	12
Approval of aircraft materials, parts, processes, and appliances ( <i>FAA rules which apply to sec. 4b.18</i> ).....	4b.18-1	12
Application of Technical Standard Orders—C Series ( <i>FAA policies which apply to sec. 4b.18</i> ).....	4b.18-2	12
Manufacturer ( <i>FAA interpretation which applies to sec. 4b.18 (b)</i> ).....	4b.18-3	13
Approval of products under the type certificate or modification procedures ( <i>FAA policies which apply to sec. 4b.18 (b)</i> ).....	4b.18-4	13
Changes in type design.....	4b.19	14

## Subpart B—Flight

### General

Proof of compliance.....	4b.100	14
Procedure for demonstrating compliance with the flight requirements ( <i>FAA policies which apply to sec. 4b.100 (a)</i> ).....	4b.100-1	14
Selection of weight, altitudes, speeds and wing flap positions ( <i>FAA policies which apply to sec. 4b.100 (b)</i> ).....	4b.100-2	15
Flying qualities ( <i>FAA policies which apply to sec. 4b.100 (c)</i> ).....	4b.100-3	17
Weight limitations.....	4b.101	17
Center of gravity limitations.....	4b.102	17
Additional limitations on weight distribution.....	4b.103	17
Empty weight.....	4b.104	17
Use of ballast.....	4b.105	17
Use of ballast during flight tests ( <i>FAA policies which apply to sec. 4b.105</i> ).....	4b.105-1	17

## Performance

	Section	Page
<b>General</b> .....	4b.110	18
Engine power corrections ( <i>FAA policies which apply to sec. 4b.110</i> ).....	4b.110-1	18
Engine power calibration ( <i>FAA policies which apply to sec. 4b.110</i> ).....	4b.110-2	18
<b>Wing flap positions</b> .....	4b.111	21
Selection of the wing flap positions ( <i>FAA policies which apply to sec. 4b.111</i> ).....	4b.111-1	21
<b>Stalling speeds</b> .....	4b.112	21
Procedure for determining stalling speeds ( <i>FAA policies which apply to sec. 4b.112 (c)</i> ).....	4b.112-1	22
<b>Takeoff; general</b> .....	4b.113	24
Downwind takeoff ( <i>FAA policies which apply to sec. 4b.113</i> ).....	4b.113-1	24
Determination of the takeoff field length ( <i>FAA policies which apply to sec. 4b.113</i> ).....	4b.113-2	26
<b>Takeoff speeds</b> .....	4b.114	26
Selection of the takeoff speeds ( <i>FAA policies which apply to sec. 4b.114</i> ).....	4b.114-1	27
<b>Accelerate-stop distance</b> .....	4b.115	27
Determination of the accelerate-stop distance ( <i>FAA policies which apply to sec. 4b.115</i> ).....	4b.115-1	28
Approval of automatic propeller feathering installations for use in establishing accelerate-stop distance ( <i>FAA policies which apply to sec. 4b.115</i> ).....	4b.115-2	29
Reverse thrust used in accelerate-stop distance ( <i>FAA policies which apply to sec. 4b.115</i> ).....	4b.115-3	29
Accelerate-stop distance with an antiskid device installed ( <i>FAA policies which apply to sec. 4b.115</i> ).....	4b.115-4	29
<b>Takeoff path</b> .....	4b.116	29
Approval of automatic propeller feathering installations for use in establishing the takeoff path ( <i>FAA policies which apply to sec. 4b.116</i> ).....	4b.116-1	30
Determination of the takeoff path ( <i>FAA policies which apply to sec. 4b.116</i> ).....	4b.116-2	31
<b>Temperature accountability</b> .....	4b.117	32
<b>Climb; general</b> .....	4b.118	33
Test procedures for the determination of climb performance ( <i>FAA policies which apply to sec. 4b.118</i> ).....	4b.118-1	34
<b>Climb; all engines operating</b> .....	4b.119	36
Determination of all engine climb ( <i>FAA policies which apply to sec. 4b.119</i> ).....	4b.119-1	36
<b>One-engine-inoperative climb</b> .....	4b.120	37
Approval of automatic propeller feathering installations for use in establishing flaps in takeoff position climb ( <i>FAA policies which apply to sec. 4b.120 (a) and (b)</i> ).....	4b.120-1	37
Determination of one-engine-inoperative climb ( <i>FAA policies which apply to sec. 4b.120</i> ).....	4b.120-2	38
<b>Two-engine-inoperative climb</b> .....	4b.121	38
Determination of two-engine-inoperative climb ( <i>FAA policies which apply to sec. 4b.121</i> ).....	4b.121-1	38
<b>Determination of the landing distance; general</b> .....	4b.122	39
Downwind landings ( <i>FAA policies which apply to sec. 4b.122</i> ).....	4b.122-1	39
Determination of the landing distances ( <i>FAA policies which apply to sec. 4b.122</i> ).....	4b.122-2	40
Reverse thrust used in determination of landing distance ( <i>FAA policies which apply to sec. 4b.122</i> ).....	4b.122-3	40
Determination of the landing distance with an antiskid device installed ( <i>FAA policies which apply to sec. 4b.122</i> ).....	4b.122-4	40
<b>Landplanes</b> .....	4b.123	41
Excessive wear of brakes or tires ( <i>FAA interpretations which apply to sec. 4b.123 (b)</i> ).....	4b.123-1	41
Determination of the landing distance (landplanes) ( <i>FAA policies which apply to sec. 4b.123</i> ).....	4b.123-2	41

	Section	Page
<b>Landplanes—Continued</b>		
Reverse thrust used in landing distance —landplanes ( <i>FAA policies which apply to sec. 4b.123 (c)</i> ) .....	4b.123-3	42
Procedure in determination of landing distance with an antiskid device installed ( <i>FAA policies which apply to sec. 4b.123</i> ) .....	4b.123-4	42
<b>Seaplanes or floatplanes</b> .....	4b.124	42
Determination of the landing distance (seaplanes) ( <i>FAA policies which apply to sec. 4b.124</i> ) .....	4b.124-1	42
<b>Skiplanes</b> .....	4b.125	42
Determination of the landing distances (skiplanes) ( <i>FAA policies which apply to sec. 4b.125</i> ) .....	4b.125-1	42
<b>Controllability</b>		
<b>Controllability; general</b> .....	4b.130	42
Procedure for demonstrating controllability qualities ( <i>FAA policies which apply to sec. 4b.130</i> ) .....	4b.130-1	42
<b>Longitudinal control</b> .....	4b.131	43
Procedure for demonstrating longitudinal control ( <i>FAA policies which apply to sec. 4b.131</i> ) .....	4b.131-1	44
<b>Directional and lateral control</b> .....	4b.132	45
Procedure for demonstrating directional and lateral control ( <i>FAA policies which apply to sec. 4b.132</i> ) .....	4b.132-1	46
<b>Minimum control speed, <math>V_{MC}</math></b> .....	4b.133	47
Determination of the minimum control speed, $V_{MC}$ ( <i>FAA policies which apply to sec. 4b.133</i> ) .....	4b.133-1	48
<b>Trim</b>		
<b>General</b> .....	4b.140	49
General trim qualities ( <i>FAA policies which apply to sec. 4b.140</i> ) .....	4b.140-1	49
<b>Lateral and directional trim</b> .....	4b.141	49
Procedure for demonstrating lateral and directional trim ( <i>FAA policies which apply to sec. 4b.141</i> ) .....	4b.141-1	49
<b>Longitudinal trim</b> .....	4b.142	50
Procedure for demonstrating longitudinal trim ( <i>FAA policies which apply to sec. 4b.142</i> ) .....	4b.142-1	50
<b>Longitudinal, directional, and lateral trim</b> .....	4b.143	50
Procedure for demonstrating longitudinal, directional, and lateral trim ( <i>FAA policies which apply to sec. 4b.143</i> ) .....	4b.143-1	50
<b>Trim for airplanes with four or more engines</b> .....	4b.144	51
Procedure for demonstrating trim for airplanes with four or more engines ( <i>FAA policies which apply to sec. 4b.144</i> ) .....	4b.144-1	51
<b>Stability</b>		
<b>General</b> .....	4b.150	51
<b>Static longitudinal stability</b> .....	4b.151	51
<b>Stability during landing</b> .....	4b.152	52
<b>Stability during approach</b> .....	4b.153	52
<b>Stability during climb</b> .....	4b.154	52
<b>Stability during cruising</b> .....	4b.155	52
<b>Dynamic longitudinal stability</b> .....	4b.156	53
Procedure for demonstrating dynamic longitudinal stability ( <i>FAA policies which apply to sec. 4b.156</i> ) .....	4b.156-1	53
<b>Static directional and lateral stability</b> .....	4b.157	53
Procedure for demonstrating static directional and lateral stability ( <i>FAA policies which apply to sec. 4b.157</i> ) .....	4b.157-1	53
<b>Dynamic directional and lateral stability</b> .....	4b.158	54
Procedure for demonstrating dynamic directional and lateral stability ( <i>FAA policies which apply to sec. 4b.158</i> ) .....	4b.158-1	54

## Stalling Characteristics

	Section	Page
<b>Stalling; symmetrical power</b> .....	4b.160.....	55
Procedure for demonstrating stall tests, symmetrical power ( <i>FAA policies which apply to sec. 4b.160 (c) (2)</i> ).....	4b.160-1.....	56
<b>Stalling; asymmetrical power</b> .....	4b.161.....	58
Procedure for demonstrating stall tests, asymmetrical power ( <i>FAA policies which apply to sec. 4b.161</i> ).....	4b.161-1.....	58
<b>Stall warning</b> .....	4b.162.....	58
Stall warning ( <i>FAA policies which apply to sec. 4b.162</i> ).....	4b.162-1.....	59

## Ground Handling Characteristics

<b>Longitudinal stability and control</b> .....	4b.170.....	59
Procedure for demonstrating longitudinal stability and control on the ground ( <i>FAA policies which apply to sec. 4b.170</i> ).....	4b.170-1.....	59
Longitudinal stability and control with reverse thrust ( <i>FAA policies which apply to sec. 4b.170</i> ).....	4b.170-2.....	59
Longitudinal stability and control with an antiskid device installed ( <i>FAA policies which apply to sec. 4b.170</i> ).....	4b.170-3.....	59
<b>Directional stability and control</b> .....	4b.171.....	59
Procedure for demonstrating directional stability and control on the ground ( <i>FAA policies which apply to sec. 4b.171</i> ).....	4b.171-1.....	60
Directional stability and control with reverse thrust ( <i>FAA policies which apply to sec. 4b.171</i> ).....	4b.171-2.....	60
Directional stability and control with an antiskid device installed ( <i>FAA policies which apply to sec. 4b.171</i> ).....	4b.171-3.....	60
<b>Shock absorption</b> .....	4b.172.....	60
Shock absorbing mechanism tests ( <i>FAA policies which apply to sec. 4b.172</i> ).....	4b.172-1.....	60
<b>Demonstrated crosswind</b> .....	4b.173.....	60
Crosswind demonstration ( <i>FAA policies which apply to sec. 4b.173</i> ).....	4b.173-1.....	60
Ground handling characteristics with reverse thrust ( <i>FAA policies which apply to sec. 4b.173</i> ).....	4b.173-2.....	60

## Water Handling Characteristics

<b>Water conditions</b> .....	4b.180.....	61
Water handling qualities ( <i>FAA policies which apply to sec. 4b.180</i> ).....	4b.180-1.....	61
<b>Wind conditions</b> .....	4b.181.....	61
Crosswind demonstration ( <i>FAA policies which apply to sec. 4b.181</i> ).....	4b.181-1.....	61
<b>Control and stability on the water</b> .....	4b.182.....	61
Procedure for demonstrating control and stability on the water ( <i>FAA policies which apply to sec. 4b.182</i> ).....	4b.182-1.....	61
Control and stability on the water with reverse thrust ( <i>FAA policies which apply to sec. 4b.182</i> ).....	4b.182-2.....	61

## Miscellaneous Flight Requirements

<b>Flutter and vibration</b> .....	4b.190.....	61
Determination of flutter and vibration qualities during dive ( <i>FAA policies which apply to sec. 4b.190</i> ).....	4b.190-1.....	62
<b>High-speed characteristics</b> .....	4b.191.....	62

## Subpart C—Structure

### General

	<i>Section</i>	<i>Page</i>
Loads.....	4b.200.....	63
Strength and deformation.....	4b.201.....	63
Proof of structure.....	4b.202.....	63

### Flight Loads

General.....	4b.210.....	63
Flight envelopes.....	4b.211.....	65
Effect of high lift devices.....	4b.212.....	67
Symmetrical flight conditions.....	4b.213.....	68
Rolling conditions.....	4b.214.....	69
Yawing conditions.....	4b.215.....	69
Supplementary flight conditions.....	4b.216.....	70
Speed control devices.....	4b.217.....	71

### Control Surface and System Loads

Control surface loads; general.....	4b.220.....	71
Wing flaps.....	4b.221.....	72
Tabs.....	4b.222.....	72
Special devices.....	4b.223.....	73
Primary flight control systems.....	4b.224.....	73
Dual primary flight control systems.....	4b.225.....	73
Ground gust conditions.....	4b.226.....	73
Secondary control systems.....	4b.227.....	73

### Ground Loads

General.....	4b.230.....	74
Level landing conditions.....	4b.231.....	74
Tail-down landing conditions.....	4b.232.....	76
One-wheel landing condition.....	4b.233.....	76
Lateral drift landing condition.....	4b.234.....	76
Rebound landing condition.....	4b.234a.....	76
Ground handling conditions.....	4b.235.....	76
Unsymmetrical loads on multiple-wheel units.....	4b.236.....	80

### Water Loads

General.....	4b.250.....	81
Water loads—alternate standards ( <i>FAA policies which apply to sec. 4b.250</i> ).....	4b.250-1.....	81
Design weights and center of gravity positions.....	4b.251.....	81
Application of loads.....	4b.252.....	81
Hull and main float load factors.....	4b.253.....	81
Hull and main float landing conditions.....	4b.254.....	82
Hull and main float takeoff condition.....	4b.255.....	82
Hull and main float bottom pressures.....	4b.256.....	84
Auxiliary float loads.....	4b.257.....	85
Seawing loads.....	4b.258.....	86



## Emergency Landing Conditions

	<i>Section</i>	<i>Page</i>
General.....	4b.260.....	86
Structural ditching provisions.....	4b.261.....	86

## Fatigue Evaluation

Fatigue evaluation of flight structure.....	4b.270.....	86
Flight structure for fatigue evaluation ( <i>FAA policies which apply to sec. 4b.270</i> ).....	4b.270-1.....	87
Fatigue evaluation, general ( <i>FAA policies which apply to sec. 4b.270</i> ).....	4b.270-2.....	88
Fatigue evaluation of landing gear.....	4b.271.....	88

## Subpart D—Design and Construction

### General

Scope.....	4b.300.....	88
Turnbuckle safetying ( <i>FAA policies which apply to sec. 4b.300</i> ).....	4b.300-1.....	88
Materials.....	4b.301.....	88
Acceptability of materials ( <i>FAA policies which apply to sec. 4b.301</i> ).....	4b.301-1.....	88
Fabrication methods.....	4b.302.....	88
Standard fastenings.....	4b.303.....	88
Protection.....	4b.304.....	89
Inspection provisions.....	4b.305.....	89
Material strength properties and design values.....	4b.306.....	89
Material strength properties ( <i>FAA policies which apply to sec. 4b.306 (c)</i> ).....	4b.306-1.....	89
Special factors.....	4b.307.....	90
Flutter, deformation, and vibration.....	4b.308.....	91

### Control Surfaces

General.....	4b.310.....	91
Proof of strength.....	4b.311.....	91
Installation.....	4b.312.....	91
Hinges.....	4b.313.....	91

### Control Systems

General.....	4b.320.....	91
Two-control airplanes.....	4b.321.....	92
Trim controls and systems.....	4b.322.....	92
Wing flap controls.....	4b.323.....	92
Wing flap interconnection.....	4b.324.....	93
Procedure for demonstrating wing flaps that are not interconnected ( <i>FAA policies which apply to sec. 4b.324 (a)</i> ).....	4b.324-1.....	93
Control system stops.....	4b.325.....	93
Control system locks.....	4b.326.....	93
Static tests.....	4b.327.....	93
Operation tests.....	4b.328.....	93
Control system details; general.....	4b.329.....	93
Installation of turnbuckles ( <i>FAA policies which apply to sec. 4b.329 (a)</i> ).....	4b.329-1.....	94
Safetying of turnbuckles ( <i>FAA policies which apply to sec. 4b.329</i> ).....	4b.329-2.....	94
Approval of control system components ( <i>FAA policies which apply to sec. 4b.329 (a)</i> ).....	4b.329-3.....	94
Cable terminals ( <i>FAA policies which apply to sec. 4b.329 (a)</i> ).....	4b.329-4.....	94
Bellcrank and idler installation ( <i>FAA policies which apply to sec. 4b.329 (b)</i> ).....	4b.329-5.....	95
Ball and roller bearings ( <i>FAA policies which apply to sec. 4b.329 (b) (5)</i> ).....	4b.329-6.....	95

## Landing Gear

	Section	Page
General.....	4b.330	95
Shock absorbers.....	4b.331	95
Landing gear tests.....	4b.332	95
Limit load factor determination.....	4b.333	96
Retracting mechanism.....	4b.334	97
Procedure for testing landing gear retracting system ( <i>FAA policies which apply to sec. 4b.334</i> ).....	4b.334-1	97
Landing gear position indicator switches ( <i>FAA interpretations which apply to sec. 4b.334 (e)</i> ).....	4b.334-2	98
Wheels.....	4b.335	98
Tires.....	4b.336	98
Brakes.....	4b.337	99
Brake tests ( <i>FAA policies which apply to sec. 4b.337</i> ).....	4b.337-1	100
Brake systems ( <i>FAA policies which apply to sec. 4b.337</i> ).....	4b.337-2	100
Replacement or modified brakes ( <i>FAA policies which apply to sec. 4b.337</i> ).....	4b.337-3	101
Antiskid devices and installations ( <i>FAA policies which apply to sec. 4b.337</i> ).....	4b.337-4	103
Skis.....	4b.338	105

## Hulls and Floats

General.....	4b.340	105
Seaplane main floats.....	4b.341	105
Boat hulls.....	4b.342	105

## Personnel and Cargo Accommodations

Pilot compartment; general.....	4b.350	105
Noise and vibration characteristics ( <i>FAA policies which apply to sec. 4b.350 (g)</i> ).....	4b.350-1	106
Pilot compartment vision.....	4b.351	106
Procedure for demonstrating pilot compartment visibility ( <i>FAA policies which apply to sec. 4b.351</i> ).....	4b.351-1	106
Vision with reverse thrust ( <i>FAA policies which apply to sec. 4b.351</i> ).....	4b.351-2	106
Minimum area of visibility in the flight crew compartment ( <i>FAA policies which apply to sec. 4b.351 (a)</i> ).....	4b.351-3	106
Windshield and windows.....	4b.352	108
Controls.....	4b.353	109
Control tests ( <i>FAA policies which apply to sec. 4b.353</i> ).....	4b.353-1	109
Instrument arrangement.....	4b.354	109
Instrument marking.....	4b.355	109
Doors.....	4b.356	109
External doors ( <i>FAA policies which apply to sec. 4b.356</i> ).....	4b.356-1	110
Auxiliary latching devices ( <i>FAA policies which apply to sec. 4b.356 (b)</i> ).....	4b.356-2	110
Power operated external doors ( <i>FAA policies which apply to sec. 4b.356 (b)</i> ).....	4b.356-3	110
Means for safeguarding against inadvertent opening in flight ( <i>FAA policies which apply to sec. 4b.356 (b)</i> ).....	4b.356-4	111
Direct visual inspection ( <i>FAA policies which apply sec. 4b.356 (e)</i> ).....	4b.356-5	111
Visual indicating system ( <i>FAA policies which apply to sec. 4b.356 (e)</i> ).....	4b.356-6	111
Seats, berths, and safety belts.....	4b.358	111
Application of loads ( <i>FAA policies which apply to sec. 4b.358</i> ).....	4b.358-1	112
Cargo and baggage compartments.....	4b.359	112

## Emergency Provisions

General.....	4b.360	113
Ditching.....	4b.361	113

	Section	Page
<b>Emergency evacuation</b> .....	<b>4b.362</b> .....	113
Flight crew emergency exits ( <i>FAA policies which apply to sec. 4b.362</i> )		
(a).....	4b.362-1.....	116
Step-down distance ( <i>FAA interpretations which apply to sec. 4b.362 (b)</i> )....	4b.362-2.....	116
Number of passengers ( <i>FAA policies which apply to sec. 4b.362 (c)</i> ).....	4b.362-3.....	116
Emergency exit design descent means ( <i>FAA policies which apply to sec. 4b.362 (e) (7)</i> ).....	4b.362-4.....	116
Emergency exit marking ( <i>FAA policies which apply to sec. 4b.362 (f)</i> )....	4b.362-5.....	117
Emergency exit access ( <i>FAA policies which apply to sec. 4b.362 (g)</i> ).....	4b.362-6.....	117
Width of main aisle ( <i>FAA policies which apply to sec. 4b.362 (h)</i> ).....	4b.362-7.....	117

### Ventilation, Heating, and Pressurization

<b>General</b> .....	<b>4b.370</b> .....	117
<b>Ventilation</b> .....	<b>4b.371</b> .....	117
Carbon monoxide detection ( <i>FAA policies which apply to sec. 4b.371</i> )....	4b.371-1.....	118
<b>Heating systems</b> .....	<b>4b.372</b> .....	118
Combustion heaters equipped with carbon dioxide fire extinguishers ( <i>FAA policies which apply to sec. 4b.372</i> ).....	4b.372-1.....	118
<b>Pressurized cabins; general</b> .....	<b>4b.373</b> .....	118
<b>Pressure equipment and supply</b> .....	<b>4b.374</b> .....	118
<b>Pressure control</b> .....	<b>4b.375</b> .....	118
Warning indication ( <i>FAA policies which apply to sec. 4b.375 (f)</i> ).....	4b.375-1.....	119
<b>Tests</b> .....	<b>4b.376</b> .....	119

### Fire Protection

<b>General</b> .....	<b>4b.380</b> .....	119
Protective breathing equipment ( <i>FAA policies which apply to sec. 4b.380</i> )		
(c).....	4b.380-1.....	120
Approved hand fire extinguishers ( <i>FAA policies which apply to sec. 4b.380 (a)</i> ).....	4b.380-2.....	120
<b>Cabin interiors</b> .....	<b>4b.381</b> .....	120
Hand fire extinguishers for cabin interiors ( <i>FAA policies which apply to sec. 4b.381 (e) and (f)</i> ).....	4b.381-1.....	121
<b>Cargo and baggage compartments</b> .....	<b>4b.382</b> .....	121
<b>Cargo compartment classification</b> .....	<b>4b.383</b> .....	121
<b>Proof of compliance</b> .....	<b>4b.384</b> .....	123
Cargo and baggage compartments equipped with carbon dioxide fire extinguishers ( <i>FAA policies which apply to sec. 4b.384</i> ).....	4b.384-1.....	123
<b>Flammable fluid fire protection</b> .....	<b>4b.385</b> .....	123
<b>Combustion heater fire protection</b> .....	<b>4b.386</b> .....	123

### Miscellaneous

<b>Reinforcement near propellers</b> .....	<b>4b.390</b> .....	124
<b>Leveling marks</b> .....	<b>4b.391</b> .....	124

## Subpart E—Powerplant

### Installation

<b>General</b> .....	<b>4b.400</b> .....	124
Engine and propeller operation ( <i>FAA policies which apply to sec. 4b.400</i> )	4b.400-1.....	125
Powerplant installation components ( <i>FAA interpretations which apply to sec. 4b.400</i> ).....	4b.400-2.....	125
<b>Engines</b> .....	<b>4b.401</b> .....	125
Approval of automatic propeller feathering system ( <i>FAA policies which apply to sec. 4b.401 (c)</i> ).....	4b.401-1.....	125
Propeller feathering system operational tests ( <i>FAA policies which apply to sec. 4b.401 (c)</i> ).....	4b.401-2.....	126
Continued rotation of turbine engines ( <i>FAA policies which apply to sec. 4b.401 (c)</i> ).....	4b.401-3.....	126
Engine operation with automatic propeller control system installed ( <i>FAA policies which apply to sec. 4b.401 (b)</i> ).....	4b.401-4.....	127

	Section	Page
<b>Propellers</b> .....	4b.402.....	127
Reverse thrust propeller installations ( <i>FAA policies which apply to sec. 4b.402</i> ).....	4b.402-1.....	127
<b>Propeller vibration</b> .....	4b.403.....	128
<b>Propeller pitch and speed limitations</b> .....	4b.404.....	128
<b>Propeller clearance</b> .....	4b.405.....	128
<b>Propeller deicing provisions</b> .....	4b.406.....	129
Fluid type propeller deicing test ( <i>FAA policies which apply to sec. 4b.406</i> ).....	4b.406-1.....	129
<b>Reversing systems</b> .....	4b.407.....	129
Investigation of propeller systems which produce negative thrust ( <i>FAA policies which apply to sec. 4b.407</i> ).....	4b.407-1.....	129
<b>Turbopropeller-drag limiting systems</b> .....	4b.408.....	130
<b>Turbine powerplant operating characteristics</b> .....	4b.409.....	130

### Fuel System Operation and Arrangement

<b>General</b> .....	4b.410.....	130
<b>Fuel system independence</b> .....	4b.411.....	130
<b>Fuel flow</b> .....	4b.413.....	130
<b>Unusable fuel supply</b> .....	4b.416.....	130
<b>Fuel system hot weather operation</b> .....	4b.417.....	131
Hot weather fuel system tests ( <i>FAA policies which apply to sec. 4b.417</i> ).....	4b.417-1.....	131
<b>Flow between interconnected tanks</b> .....	4b.418.....	132

### Fuel System Construction and Installation

<b>General</b> .....	4b.420.....	132
Minimum quantity of antidetonant fluid required ( <i>FAA policies which apply to sec. 4b.420 (e)</i> ).....	4b.420-1.....	132
<b>Fuel tank tests</b> .....	4b.421.....	133
<b>Fuel tank installation</b> .....	4b.422.....	134
<b>Fuel tank expansion space</b> .....	4b.423.....	134
<b>Fuel tank sump</b> .....	4b.424.....	134
<b>Fuel tank filler connection</b> .....	4b.425.....	134
<b>Fuel tank vents and carburetor vapor vents</b> .....	4b.426.....	134
<b>Fuel tank outlet</b> .....	4b.427.....	135
<b>Under-wing fueling provisions</b> .....	4b.428.....	135

### Fuel System Components

<b>Fuel pumps</b> .....	4b.430.....	135
Fuel injection pump ( <i>FAA interpretations which apply to sec. 4b.430</i> ).....	4b.430-1.....	135
<b>Fuel system lines and fittings</b> .....	4b.432.....	135
<b>Fuel lines and fittings in designated fire zones</b> .....	4b.433.....	136
<b>Fuel valves</b> .....	4b.434.....	136
<b>Fuel strainer or filter</b> .....	4b.435.....	136
<b>Fuel system drains</b> .....	4b.436.....	136
<b>Fuel jettisoning system</b> .....	4b.437.....	136
Test procedure for fuel jettisoning ( <i>FAA policies which apply to sec. 4b.437</i> ).....	4b.437-1.....	137

### Oil System

<b>General</b> .....	4b.440.....	138
<b>Oil tank construction</b> .....	4b.441.....	138
<b>Oil tank tests</b> .....	4b.442.....	139
<b>Oil tank installation</b> .....	4b.443.....	139
<b>Oil lines and fittings</b> .....	4b.444.....	139
<b>Oil valves</b> .....	4b.445.....	139
<b>Oil radiators</b> .....	4b.446.....	139

	Section	Page
Oil filters.....	4b.447	139
Oil system drains.....	4b.448	140
Propeller feathering system.....	4b.449	140
Procedure for demonstrating propeller feathering ( <i>FAA policies which apply to sec. 4b.449</i> ).....	4b.449-1	140

### Cooling System

General.....	4b.450	140
Cooling tests.....	4b.451	140
Cooling test procedures.....	4b.452	141
Cooling test procedure for flying boat operation.....	4b.454	141

### Induction and Exhaust Systems

General.....	4b.460	141
Induction system deicing and anti-icing provisions.....	4b.461	141
Procedure for demonstrating carburetor air heat rise ( <i>FAA policies which apply to sec. 4b.461 (b)</i> ).....	4b.461-1	142
Carburetor air preheater design.....	4b.462	142
Induction system ducts.....	4b.463	142
Induction system screens.....	4b.464	142
Inter-coolers and after-coolers.....	4b.466	143
Exhaust system and installation components.....	4b.467	143
Carbon monoxide detection ( <i>FAA policies which apply to sec. 4b.467 (a) (1) and (d)</i> ).....	4b.467-1	144
Determination of exhaust gas interference with visibility ( <i>FAA policies which apply to sec. 4b.467 (a) (5)</i> ).....	4b.467-2	144

### Powerplant Controls and Accessories

Powerplant controls; general.....	4b.470	144
Throttle and A. D. I. system controls.....	4b.471	144
Ignition switches.....	4b.472	145
Mixture controls.....	4b.473	145
Propeller controls.....	4b.474	145
Propeller feathering pump motors, intermittent duty type ( <i>FAA policies which apply to sec. 4b.474 (b)</i> ).....	4b.474-1	145
Reverse thrust controls.....	4b.474a	145
Fuel system controls.....	4b.475	146
Carburetor air preheat controls.....	4b.476	146
Supercharger controls.....	4b.476a	146
Powerplant accessories.....	4b.477	146
Engine ignition systems.....	4b.478	146

### Powerplant Fire Protection

Designated fire zones.....	4b.480	146
Flammable fluids.....	4b.481	147
Shutoff means.....	4b.482	147
Lines and fittings.....	4b.483	147
Fire extinguisher systems.....	4b.484	147
Determination of carbon dioxide concentration in flight crew compartments ( <i>FAA policies which apply to sec. 4b.484 (b)</i> ).....	4b.484-1	148
Fire-detector systems.....	4b.485	149
Fire detector test circuit ( <i>FAA policies which apply to sec. 4b.485 (c)</i> ).....	4b.485-1	149
Firewalls.....	4b.486	149
Cowling and nacelle skin.....	4b.487	150
Drainage and ventilation of fire zones.....	4b.489	150
Protection of other airplane components against fire.....	4b.490	150

## Subpart F—Equipment

### General

	Section	Page
Scope.....	4b.600	150
Functional and installational requirements.....	4b.601	151
Required basic equipment.....	4b.602	151
Flight and navigational instruments.....	4b.603	151
Powerplant instruments.....	4b.604	151
Miscellaneous equipment.....	4b.605	152
Equipment, systems, and installations.....	4b.606	152
Safety criteria for electric utilization systems ( <i>FAA policies which apply to sec. 4b.606 (a) and (b)</i> ).....	4b.606-1	152
Installation of flight recorders ( <i>FAA policies which apply to sec. 4b.606</i> ).....	4b.606-2	153

### Instruments; Installation

General.....	4b.610	154
Arrangement and visibility of instrument installations.....	4b.611	154
Procedure for checking arrangement and visibility of instrument installations ( <i>FAA policies which apply to sec. 4b.611</i> ).....	4b.611-1	154
Flight and navigational instruments.....	4b.612	154
Airspeed indicating system calibration ( <i>FAA policies which apply to sec. 4b.612 (a)</i> ).....	4b.612-1	156
Static air vent system ( <i>FAA policies which apply to sec. 4b.612 (b)</i> ).....	4b.612-2	157
Calibration of magnetic direction indicator ( <i>FAA policies which apply to sec. 4b.612 (c)</i> ).....	4b.612-3	158
Automatic pilot systems ( <i>FAA policies which apply to sec. 4b.612 (d)</i> ).....	4b.612-4	158
Connection of additional instruments to duplicate instrument system ( <i>FAA policies which apply to sec. 4b.612 (f)</i> ).....	4b.612-5	159
Powerplant instruments.....	4b.613	159

### Electrical Systems and Equipment

General.....	4b.620	160
Electrical system capacity.....	4b.621	160
Generating system.....	4b.622	160
Generating system reliability ( <i>FAA policies which apply to sec. 4b.622 (b)</i> ).....	4b.622-1	161
Distribution system.....	4b.623	161
Electrical protection.....	4b.624	161
Automatic reset circuit breaker ( <i>FAA policies which apply to sec. 4b.624</i> ).....	4b.624-1	162
Electrical equipment and installation.....	4b.625	162
Environmental tests for electrical equipment ( <i>FAA policies which apply to sec. 4b.625 (a)</i> ).....	4b.625-1	162
Electrical system fire and smoke protections.....	4b.626	163
Fire-resistant electrical equipment ( <i>FAA policies which apply to sec. 4b.626</i> ).....	4b.626-1	163
Electrical system tests.....	4b.627	163
Lightning strike protection.....	4b.628	164

### Lights

Instrument lights.....	4b.630	164
Landing lights.....	4b.631	164
Position light system installation.....	4b.632	164
Red passing lights ( <i>FAA policies which apply to sec. 4b.632 (a)</i> ).....	4b.632-1	164
Position light system dihedral angles.....	4b.633	164

	Section	Page
<b>Position light distribution and intensities</b> .....	4b.634.....	165
Overlaps between high intensity forward position lights ( <i>FAA policies which apply to sec. 4b.634 (b) (3)</i> ).....	4b.634-1.....	166
<b>Position light color specifications</b> .....	4b.635.....	166
<b>Riding light</b> .....	4b.636.....	166
<b>Anticollision light</b> .....	4b.637.....	166

### Safety Equipment

<b>Ice protection</b> .....	4b.640.....	175
<b>Hand fire extinguishers</b> .....	4b.641.....	175
<b>Flare installation</b> .....	4b.642.....	175
Procedure for testing flare ejection ( <i>FAA policies which apply to sec. 4b.642 (b)</i> ).....	4b.642-1.....	175
<b>Safety belts</b> .....	4b.643.....	175
<b>Safety belt signal</b> .....	4b.644.....	175
<b>Ditching equipment</b> .....	4b.645.....	175
<b>Stowage of safety equipment</b> .....	4b.646.....	176
<b>Flotation means</b> .....	4b.647.....	176

### Miscellaneous Equipment

<b>Radio and electronic equipment</b> .....	4b.650.....	176
<b>Oxygen equipment and supply</b> .....	4b.651.....	177
Safety precautions ( <i>FAA policies which apply to sec. 4b.651 (a)</i> ).....	4b.651-1.....	179
Protective breathing equipment ( <i>FAA policies which apply to sec. 4b.651 (h)</i> ).....	4b.651-2.....	179
Supplemental breathing equipment ( <i>FAA policies which apply to sec. 4b.651</i> ).....	4b.651-3.....	179
Design considerations for fixed systems ( <i>FAA policies which apply to sec. 4b.651</i> ).....	4b.651-4.....	180
Portable walk-around oxygen units ( <i>FAA policies which apply to sec. 4b.651</i> ).....	4b.651-5.....	180
Oxygen pressure gage ( <i>FAA policies which apply to sec. 4b.651 (a)</i> ).....	4b.651-6.....	181
Supply required for continuous flow supplementary breathing systems ( <i>FAA policies which apply to sec. 4b.651 (b)</i> ).....	4b.651-7.....	181
Supply required for diluter-demand system ( <i>FAA policies which apply to sec. 4b.651</i> ).....	4b.651-8.....	181
Requirements for approval of oxygen systems ( <i>FAA policies which apply to sec. 4b.651 (b)</i> ).....	4b.651-9.....	182
Means for determining oxygen flow to crewmembers ( <i>FAA policies which apply to sec. 4b.651 (e)</i> ).....	4b.651-10.....	182
Means for determining oxygen flow to passengers ( <i>FAA policies which apply to sec. 4b.651 (e)</i> ).....	4b.651-11.....	183
Types of flow indicators ( <i>FAA policies which apply to sec. 4b.651 (e)</i> ).....	4b.651-12.....	183
<b>Hydraulic systems; strength</b> .....	4b.653.....	184
<b>Hydraulic systems; design</b> .....	4b.654.....	184
<b>Hydraulic system fire protection</b> .....	4b.655.....	184
<b>Vacuum systems</b> .....	4b.658.....	184
<b>Draining of fluids subject to freezing</b> .....	4b.660.....	184

## Subpart G—Operating Limitations and Information

### General

<b>Scope</b> .....	4b.700.....	184
Automatic propeller feathering operating limitations and information ( <i>FAA policies which apply to sec. 4b.700</i> ).....	4b.700-1.....	184

## Operating Limitations

	<i>Section</i>	<i>Page</i>
Airspeed limitations; general.....	4b.710.....	185
Maximum operating limit speed $V_{MO}/M_{MO}$ .....	4b.711.....	185
Maneuvering speed.....	4b.713.....	185
Flap extended speed $V_{FE}$ .....	4b.714.....	185
Landing gear operating speed $V_{LO}$ .....	4b.715.....	185
Landing gear extended speed $V_{LE}$ .....	4b.716.....	185
Minimum control speed $V_{MC}$ .....	4b.717.....	186
Powerplant limitations.....	4b.718.....	186
Powerplant limitations governing minimum quantity of antidetonant fluid required for takeoff ( <i>FAA policies which apply to sec. 4b.718</i> ).....	4b.718-1.....	186
Airplane weight, center of gravity, and weight distribution limitations.....	4b.719.....	186
Minimum flight crew.....	4b.720.....	186
Types of operation.....	4b.721.....	186
Maximum operating altitude.....	4b.722.....	186
Maneuvering flight load factors.....	4b.723.....	186

## Markings and Placards

General.....	4b.730.....	187
Reverse thrust placards ( <i>FAA policies which apply to sec. 4b.730</i> ).....	4b.730-1.....	187
Instrument markings; general.....	4b.731.....	187
Airspeed limitation information.....	4b.732.....	187
Magnetic direction indicator.....	4b.733.....	187
Powerplant instruments; general.....	4b.734.....	187
Oil quantity indicators.....	4b.735.....	187
Fuel quantity indicator.....	4b.736.....	187
Control markings; general.....	4b.737.....	187
Miscellaneous markings and placards.....	4b.738.....	188

## Airplane Flight Manual

General.....	4b.740.....	188
Preparation of Airplane Flight Manuals for aircraft certificated in the transport category ( <i>FAA policies which apply to sec. 4b.740</i> ).....	4b.740-1.....	188
Reverse thrust operating limitations and procedures ( <i>FAA policies which apply to sec. 4b.740</i> ).....	4b.740-2.....	197
Operating limitations.....	4b.741.....	197
Operating procedures.....	4b.742.....	198
Performance information.....	4b.743.....	198

## Airplane Identification Data

Identification plate.....	4b.750.....	198
Identification marks.....	4b.751.....	198

## Appendixes

Summary of Appendixes.....	199
----------------------------	-----

### Appendix A

FIGURE 1.—Weight—c. g. positions.....	201
FIGURE 2.—Wind gradient correction.....	202
FIGURE 3.—Static longitudinal stability requirements.....	203
FIGURE 4.—Altimeter position error.....	204
FIGURE 5.—Turnbuckle safety wiring.....	205



FIGURE 6.—Reference eye position.....	Page 206
FIGURE 7.—Clear areas of vision.....	207
FIGURE 8.—Obstruction to vision.....	208
FIGURE 9.—Measurement of angles.....	209

### Appendix B

List of tests normally required to show compliance with the Regulations.....	211
--	-----

### Appendix C

Sample of typical flight test programs to substantiate changes in airplane configuration...	221
---	-----

### Appendix D

A General Order of Testing.....	223
---------------------------------	-----

### Appendix E

A guide to facilitate the development of a flight test schedule.....	225
--	-----

### Appendix F

Tests requiring special instrumentation and a description of pertinent instruments.....	227
---	-----

### Appendix G

Special Civil Air Regulations which affect Part 4b.....	229
SR-389B. Emergency Exits for Airplanes Carrying Passengers for Hire.....	231
Amendment No. 1 to SR-389B.....	235
SR-392C. Facilitation of Experiments with Exterior Lighting Systems.....	237
SR-392D. Display of Experimental Exterior Lighting Systems Approved for Use on Aircraft.....	239
SR-406C. Application of Transport Category Requirements to C-46 Type Airplanes..	243
SR-407. Basis for Approval of Modification of Airplane Types Douglas DC-3 and Lockheed L-18.....	247
SR-411B. Operation of Certain Transport Category Airplanes in Cargo Service at Increased Zero Fuel and Landing Weights.....	253
SR-422. Turbine-Powered Transport Category Airplanes of Current Design.....	259
SR-422A. Turbine-Powered Transport Category Airplanes of Current Design.....	273
SR-422B. Turbine-Powered Transport Category Airplanes of Current Design.....	293
SR-425C. Provisional Certification and Operation of Aircraft.....	315
SR-426. Performance Credit for Transport Category Airplanes Equipped with Standby Power.....	325
SR-450A. Airspeed Operation Limitation for Transport Category Airplanes.....	331

### Appendix H

Fatigue Evaluation of Flight Structure.....	333
---	-----

### Appendix I

Environmental Test Procedures—Electrical Equipment.....	339
---	-----

### Addendum

Preambles of Amendments to Part 4b.....	P-1
---	-----

# Airplane Airworthiness; Transport Categories

## Subpart A—General

### Applicability and Definitions

**4b.0 Applicability of this part.** This part establishes standards with which compliance shall be demonstrated for the issuance of and changes to type certificates for transport category airplanes. This part, until superseded or rescinded, shall apply to all transport category airplanes for which applications for type certification in the transport category are made after the effective date of this part (November 9, 1945).

**4b.1 Definitions.** As used in this part terms are defined as follows:

(a) *Administration.*

(1) *Administrator.* The Administrator is the Administrator of the Federal Aviation Agency.

(2) *Applicant.* An applicant is a person or persons applying for approval of an airplane or any part thereof.

(3) *Approved.* Approved, when used alone or as modifying terms such as means, devices, specifications, etc., shall mean approved by the Administrator. (See sec. 4b.18.)

(b) *General design.*

(1) *Standard atmosphere.* The standard atmosphere is an atmosphere (see NACA Technical Report 1235) defined as follows:

(i) The air is a dry, perfect gas,

(ii) The temperature at sea level is 59°F.,

(iii) The pressure at sea level is 29.92 inches Hg,

(iv) The temperature gradient from sea level to the altitude at which the temperature equals -69.7° F. is -0.003566° F./ft. and zero thereabove,

(v) The density  $\rho_0$  at sea level under the above conditions is 0.002377 pounds sec.<sup>2</sup>/ft.<sup>4</sup>.

[(2) *Maximum ambient atmospheric temperature.* The maximum ambient atmospheric temperature is the temperature selected

by the applicant as the maximum operational limit.]

(3) *Airplane configuration.* Airplane configuration is a term referring to the position of the various elements affecting the aerodynamic characteristics of the airplane (e. g., wing flaps, landing gear).

(4) *Aerodynamic coefficients.* Aerodynamic coefficients are nondimensional coefficients for forces and moments. They correspond with those adopted by the National Aeronautics and Space Administration (formerly the National Advisory Committee for Aeronautics).

(5) *Critical engine(s).* The critical engine is that engine(s) the failure of which gives the most adverse effect on the airplane flight characteristics relative to the case under consideration.

(6) *Critical-engine-failure speed.* The critical-engine-failure speed is the airplane speed used in the determination of the takeoff at which the critical engine is assumed to fail. (See sec. 4b.114.)

(7) *Continuous maximum icing.* The maximum continuous intensity of atmospheric icing conditions is defined by the variables of the cloud liquid water content, the mean effective diameter of the cloud droplets, the ambient air temperature, and the inter-relationship of these three variables as shown in figure 4b-24a. The limiting icing envelope in terms of altitude and temperature is given in figure 4b-24b. The inter-relationship of cloud liquid water content with drop diameter and altitude is determined from figures 4b-24a and 4b-24b. The cloud liquid water content for continuous maximum icing conditions of a horizontal extent other than twenty miles is determined by the value of liquid water content of figure 4b-24a multiplied by the appropriate factor from figure 4b-24c. (See sec. 4b.640.)

(8) *Intermittent maximum icing.* The intermittent maximum intensity of atmospheric icing conditions is defined by the variables of the cloud liquid water content, the mean effective diameter of the cloud droplets, the ambient air temperature, and the inter-relationship of these three variables as shown in figure 4b-25a. The limiting icing envelope in terms of altitude and temperature is given in figure 4b-25b. The inter-relationship of cloud liquid water content with drop diameter and altitude is determined from figures 4b-25a and 4b-25b. The cloud liquid water content for intermittent maximum icing conditions of a horizontal extent other than three miles is determined by the value of cloud liquid water content of figure 4b-25a multiplied by the appropriate factor in figure 4b-25c. (See sec. 4b.640.)

NOTE: There is some indication that the upper altitude limit might extend to 30,000 feet pressure altitude, and the lower limit of ambient temperature may be as low as  $-40^{\circ}$  F. Because of this, the portions in this region of figures 4b-25a and 4b-25b are shown by dashed lines.

(c) *Weights.*

(1) *Maximum weight.* The maximum weight of the airplane is that maximum at which compliance with the requirements of this part is demonstrated. (See sec. 4b.101 (a).)

(2) *Minimum weight.* The minimum weight of the airplane is that minimum at which compliance with the requirements of this part is demonstrated. (See sec. 4b.101 (c).)

(3) *Empty weight.* The empty weight of the airplane is a readily reproducible weight which is used in the determination of the operating weights. (See sec. 4b.104.)

(4) *Design maximum weight.* The design maximum weight is the maximum weight of the airplane used in structural design for flight load conditions. (See sec. 4b.210.)

(5) *Design minimum weight.* The design minimum weight is the minimum weight of the airplane at which compliance is shown with the structural loading conditions. (See sec. 4b.210.)

(6) *Design takeoff weight.* The design takeoff weight is the maximum airplane weight used in structural design for taxiing conditions, and for landing conditions at a reduced velocity of descent. (See sec. 4b.210.)

(7) *Design landing weight.* The design landing weight is the maximum airplane weight used in structural design for landing conditions at the maximum velocity of descent. (See sec. 4b.230 (b).)

(8) *Zero fuel weight.* The zero fuel weight is the design maximum weight of the airplane with no disposable fuel and oil.

(9) *Design unit weight.* The design unit weight is a representative weight used to show compliance with the structural design requirements.

(i) Gasoline 6 pounds per U. S. gallon.

(ii) Lubricating oil 7.5 pounds per U. S. gallon.

(iii) Crew and passengers 170 pounds per person.

(d) *Speeds.*

(1) IAS: Indicated airspeed is equal to the pitot static airspeed indicator reading as installed in the airplane without correction for airspeed indicator system errors but including the sea level standard adiabatic compressible flow correction. (This latter correction is included in the calibration of the airspeed instrument dials.) (See secs. 4b.612 (a) and 4b.710.)

(2) CAS: Calibrated airspeed is equal to the airspeed indicator reading corrected for position and instrument error. (As a result of the sea level adiabatic compressible flow correction to the airspeed instrument dial, CAS is equal to the true airspeed TAS in standard atmosphere at sea level.)

(3) EAS: Equivalent airspeed is equal to the airspeed indicator reading corrected for position error, instrument error, and for adiabatic compressible flow for the particular altitude. (EAS is equal to CAS at sea level in standard atmosphere.)

(4) TAS: True airspeed of the airplane relative to undisturbed air. ( $TAS = EAS(\rho_0/\rho)^{1/2}$ .)

(5)  $V_A$ : The design maneuvering speed. (See sec. 4b.210 (b) (2).)

(6)  $V_B$ : The design speed for maximum gust intensity. (See sec. 4b.210 (b) (3).)

(7)  $V_C$ : The design cruising speed. (See sec. 4b.210 (b) (4).)

(8)  $V_D$ : The design diving speed. (See sec. 4b.210 (b) (5).)

[(9)  $V_{DF}/M_{DF}$ : The demonstrated flight diving speed at which compliance is shown with the applicable flight requirements. (See secs. 4b.190 and 4b.191 (a).)]

[(10)  $V_F$ : The design flat speeds for flight loading conditions. (See sec. 4b.210 (b) (1).)]

(11)  $V_{FE}$ : The flap extended speed is a maximum speed with wing flaps in a prescribed extended position. (See sec. 4b.714.)

(12)  $V_{LE}$ : The landing gear extended speed is the maximum speed at which the airplane can be flown safely with the landing gear extended. (See sec. 4b.716.)

(13)  $V_{LO}$ : The landing gear operating speed is a maximum speed at which the landing gear can be raised or lowered safely. (See sec. 4b.715.)

(14)  $V_{MC}$ : The minimum control speed with the critical engine inoperative. (See sec. 4b.133.)

[(15)  $V_{FC}/M_{FC}$ : The maximum speed for stability characteristics. (See sec. 4b.191 (b).)]

[(16)  $V_{MO}/M_{MO}$ : The maximum operating limit speed. (See sec. 4b.711.)]

(17)  $V_{S_0}$ : The stalling speed or the minimum steady flight speed with wing flaps in the landing position. (See secs. 4b.112 (a) and 4b.160.)

(18)  $V_{S_1}$ : The stalling speed or the minimum steady flight speed obtained in a specified configuration. (See sec. 4b.112 (b).)

(19)  $V_1$ : The critical-engine-failure speed. (See sec. 4b.114.)

(20)  $V_2$ : The takeoff safety speed. (See sec. 4b.114 (b).)

(21)  $M$ : Mach number is the ratio of true airspeed to the speed of sound.

(e) *Structural.*

(1) *Limit load.* A limit load is the maximum load anticipated in normal conditions of operation. (See sec. 4b.200.)

(2) *Ultimate load.* An ultimate load is a limit load multiplied by the appropriate factor of safety. (See sec. 4b.200.)

(3) *Factor of safety.* The factor of safety is a design factor used to provide for the possibility of loads greater than those anticipated in normal conditions of operation and for uncertainties in design. (See sec. 4b.200 (a).)

(4) *Load factor.* The load factor is the ratio of a specified load to the total weight of the airplane; the specified load may be expressed in terms of any of the following: aerodynamic forces, inertia forces, or ground or water reactions.

(5) *Limit load factor.* The limit load factor is the load factor corresponding with limit loads.

(6) *Ultimate load factor.* The ultimate load factor is the load factor corresponding with ultimate loads.

(7) *Checked pitching maneuver.* A checked pitching maneuver is one in which the pitching control is suddenly displaced in one direction and then suddenly moved in the opposite direction, the deflections and timing being such as to avoid exceeding the limit maneuvering load factor.

(8) *Design wing area.* The design wing area is the area enclosed by the wing outline (including wing flaps in the retracted position and ailerons, but excluding fillets or fairings) on a surface containing the wing chords. The outline is assumed to be extended through the nacelles and fuselage to the plane of symmetry in any reasonable manner.

(9) *Balancing tail load.* A balancing tail load is that load necessary to place the airplane in equilibrium with zero pitch acceleration.

(10) *Fitting.* A fitting is a part or terminal used to join one structural member to another. (See sec. 4b.307 (c).)

(f) *Powerplant installation.*<sup>1</sup>

<sup>1</sup> For engine airworthiness requirements see Part 13 of this subchapter; for propeller airworthiness requirements see Part 14 of this subchapter.

(1) *Brake horsepower.* Brake horsepower is the power delivered at the propeller shaft of the engine.

(2) *Takeoff power or thrust.*

(i) Takeoff power for reciprocating engines is the brake horsepower developed under standard sea level conditions and under the maximum conditions of crankshaft rotational speed and engine manifold pressure approved for the normal takeoff, and limited in use to a maximum continuous period as indicated in the approved engine specification.

(ii) Takeoff power for turbine engines is the brake horsepower developed under static conditions at specified altitudes and atmospheric temperatures and under the maximum conditions of rotor shaft rotational speed and gas temperature approved for the normal takeoff, and limited in use to a maximum continuous period as indicated in the approved engine specification.

(iii) Takeoff thrust for turbine engines is the jet thrust developed under static conditions at specified altitudes and atmospheric temperatures and under the maximum conditions of rotor shaft rotational speed and gas temperature approved for the normal takeoff, and limited in use to a maximum continuous period as indicated in the approved engine specification.

(3) *Maximum continuous power or thrust.*

(i) Maximum continuous power for reciprocating engines is the brake horsepower developed in standard atmosphere at a specified altitude and under the maximum conditions of crankshaft rotational speed and engine manifold pressure, and approved for use during periods of unrestricted duration.

(ii) Maximum continuous power for turbine engines is the brake horsepower developed at specified altitudes, atmospheric temperatures, and flight speeds and under the maximum conditions of rotor shaft rotational speed and gas temperature, and approved for use during periods of unrestricted duration.

(iii) Maximum continuous thrust for turbine engines is the jet thrust developed at specified altitudes, atmospheric temperatures, and flight speeds and under the maximum conditions of rotor shaft rotational speed and gas temperature, and approved for use during periods of unrestricted duration.

(4) *Gas temperature.* Gas temperature for turbine engines is the temperature of the gas stream obtained as indicated in the approved engine specification.

(5) *Manifold pressure.* Manifold pressure is the absolute pressure measured at the appropriate point in the induction system, usually in inches of mercury.

(6) *Critical altitude.* The critical altitude is the maximum altitude at which in

standard atmosphere it is possible to maintain, at a specified rotational speed, a specified power or a specified manifold pressure. Unless otherwise stated, the critical altitude is the maximum altitude at which it is possible to maintain, at the maximum continuous rotational speed, one of the following:

(i) The maximum continuous power, in the case of engines for which this power rating is the same at sea level and at the rated altitude,

(ii) The maximum continuous rated manifold pressure, in the case of engines the maximum continuous power of which is governed by a constant manifold pressure.

(7) *Pitch setting.* Pitch setting is the propeller blade setting determined by the blade angle measured in a manner, and at a radius, specified in the instruction manual for the propeller.

(8) *Feathered pitch.* Feathered pitch is the pitch setting which in flight, with the engines stopped, gives approximately the minimum drag and corresponds with a windmilling torque of approximately zero.

(9) *Reverse pitch.* Reverse pitch is the propeller pitch setting for any blade angle used beyond zero pitch (e. g., the negative angle used for reverse thrust).

(g) *Fire protection.*

(1) *Fireproof.* Fireproof material means a material which will withstand heat at least as well as steel in dimensions appropriate for the purpose for which it is to be used. When applied to material and parts used to confine fires in designated fire zones, fireproof means that the material or part will perform this function under the most severe conditions of fire and duration likely to occur in such zones.

(2) *Fire-resistant.* When applied to sheet or structural members, fire-resistant material means a material which will withstand heat at least as well as aluminum alloy in dimensions appropriate for the purpose for which it is to be used. When applied to fluid-carrying lines, other flammable fluid system components, wiring, air ducts, fittings, and powerplant controls, this term refers to a line and fitting assembly, component, wiring or duct, or controls, which will perform the intended functions under the heat and other

conditions likely to occur at the particular location.

(3) *Flame-resistant.* Flame-resistant material means material which will not support combustion to the point of propagating, beyond safe limits, a flame after the removal of the ignition source.

(4) *Flash-resistant.* Flash-resistant material means material which will not burn violently when ignited.

(5) *Flammable.* Flammable pertains to those fluids or gases which will ignite readily or explode.

(h) *Miscellaneous.*

(1) *Supplemental breathing equipment.* Supplemental breathing equipment is equipment designed to supply the supplementary oxygen required to protect against anoxia at altitudes where the partial pressure of oxygen in ambient air is reduced. (See sec. 4b.651.)

(2) *Protective breathing equipment.* Protective breathing equipment is equipment designed to prevent the breathing of noxious gases which might be present as contaminants in the air within the airplane in emergency situations. (See sec. 4b.651.)

(Amendment 4b-12, published 27 F.R. 2986, Mar. 30, 1962, effective May 3, 1962.)

## Certification

**4b.10 Eligibility for type certificates.** An airplane shall be eligible for type certification under the provisions of this part if it complies with the airworthiness provisions established by this part or if the Administrator finds that the provision or provisions not complied with are compensated for by factors which provide an equivalent level of safety: *Provided*, That the Administrator finds no feature or characteristic of the airplane which renders it unsafe for the transport category.

4b.10-1 *Approval of reverse thrust propellers (FAA policies which apply to sec. 4b.10).* A reverse thrust propeller is a design feature which is not fully covered in the Civil Air Regulations. When an airplane incorporates a reverse thrust propeller installation, it will be approved in accordance with the policies set forth in section 4b.402-1, provided it has no feature or char-

acteristic which renders its use unsafe in transport category airplanes.

(20 F. R. 2277, Apr. 8, 1955, effective Apr. 30, 1955.)

4b.10-2 *Approval of automatic propeller feathering installations (FAA policies which apply to sec. 4b.10).* An automatic propeller feathering device is a design feature not specifically covered in the Civil Air Regulations. When an airplane incorporates an automatic feathering device, it will be acceptable under the provisions of section 4b.10 as providing an equivalent level of safety in showing compliance with sections 4b.115, 4b.116, 4b.120, and 4b.133 if it complies with policies prescribed in sections 4b.115-2, 4b.116-1, 4b.120-1, 4b.401-1, and 4b.700-1, and if there are no features or characteristics which make it unsafe for use on transport aircraft.

(19 F. R. 1817, Apr. 2, 1954, effective Apr. 2, 1954.)

4b.10-3 *Minimum quantity of antidetonant fluid required (FAA policies which apply to sec. 4b.10).* The use of antidetonant fluid in limited quantities as a supplemental fluid for takeoff power operations is a feature not specifically covered in the Civil Air Regulations. A system incorporating antidetonant fluid will be acceptable under the provisions of section 4b.10 as providing a satisfactory level of safety from the standpoint of the quantity of fluid available if it complies with the policies contained in sections 4b.420-1 and 4b.718-1.

(20 F. R. 2277, Apr. 8, 1955, effective Apr. 30, 1955.)

**4b.11 Designation of applicable regulations.** The provisions of this section shall apply to all airplane types certificated under this part irrespective of the date of application for type certificate.

(a) Unless otherwise established by the Board, the airplane shall comply with the provisions of this part together with all amendments thereto effective on the date of application for type certificate, except that compliance with later amendments may be elected or required pursuant to paragraphs (c), (d), (e), [and (f)] of this section.

(b) If the interval between the date of application for type certificate and the issuance of the corresponding type certificate exceeds five years, a new application for type certificate shall be required, notwithstanding the applicant

may have been issued a provisional type certificate, except that for applications pending on May 1, 1954, such five-year period shall commence on that date. At the option of the applicant, a new application may be filed prior to the expiration of the five-year period. In either instance the applicable regulations shall be those effective on the date of the new application in accordance with paragraph (a) of this section.

(c) During the interval between filing the application and the issuance of a type certificate, the applicant may elect to show compliance with any amendment of this part which becomes effective during that interval, in which case all other amendments found by the Administrator to be directly related shall be complied with.

(d) Except as otherwise provided by the Administrator pursuant to section 1.24 of this subchapter, a change to the type certificate (see sec. 4b.13 (b)) may be accomplished, at the option of the holder of the type certificate, either in accordance with the regulations incorporated by reference in the type certificate pursuant to section 4b.13 (c), or in accordance with subsequent amendments to such regulations in effect on the date of application for approval of the change, subject to the following provisions:

(1) When the applicant elects to show compliance with an amendment to the regulations in effect on the date of application for approval of a change, he shall show compliance with all amendments which the Administrator finds are directly related to the particular amendment selected by the applicant.

(2) When the change consists of a new design or a substantially complete redesign of a component, equipment installation, or system installation of the airplane, and the Administrator finds that the regulations incorporated by reference in the type certificate pursuant to section 4b.13 (c) do not provide complete standards with respect to such change, he shall require compliance with such provisions of the regulations in effect on the date of application for approval of the change as he finds will provide a level of safety equal to that established by the regulations incorporated by reference at the time of issuance of the type certificate.

NOTE: Examples of new or redesigned components and installations which might require compliance with regulations in effect on the date of application for approval, are: New powerplant installation which is likely to introduce additional fire or operational hazards unless additional protective measures are incorporated; the installation of an autopilot, a pressurization system, or a new electric power system.

(e) If changes listed in subparagraphs (1) through (3) of this paragraph are made, the airplane shall be considered as a new type, in which case a new application for type certificate shall be required and the regulations together with all amendments thereto effective on the date of the new application shall be made applicable in accordance with paragraphs (a), (b), (c), and (d) of this section.

(1) A change in the number of engines;

(2) A change to engines employing different principles of propulsion;

(3) A change in design, configuration, power, or weight which the Administrator finds is so extensive as to require a substantially complete investigation of compliance with the regulations.

[(f) Except as otherwise required by paragraph (e) (3) of this section compliance with the provisions of subparagraphs (1) and (2) of this paragraph is required for the type certification of a turbopropeller-powered airplane which was previously type certificated with the same number of reciprocating engines:

[(1) The requirements of this part applicable to the airplane as type certificated with reciprocating engines and, in addition thereto or in lieu thereof as appropriate, the provisions of subdivisions (i) through (iv) of this subparagraph, effective on the date of application for type certification of the turbopropeller-powered airplane;

[(i) The certification performance requirements prescribed in paragraph (2) of Special Civil Air Regulation No. SR-422B;

[(ii) The powerplant requirements of this part applicable to the turboprop airplane;

[(iii) The requirements of this part for the standardization of cockpit controls and instruments, except when a showing of compliance with a particular detailed requirement would be impractical and would not contribute materially to standardization; and

[(iv) Such other requirements of this part applicable to the turboprop airplane which are found to be related to the changes in engines and which are necessary to insure a level of safety of the turboprop airplane equivalent to that established for the airplane certificated with reciprocating engines.

[(2) If new limitations are established with respect to weight, speed, or altitude of operation, which are significantly altered from those approved for the airplane with reciprocating engines, compliance shall be shown with all of the requirements of this part, applicable to the specific limitations being changed, which are in effect on the date of application for type certification of the turbopropeller-powered airplane.]

(Amendment 4b-12, published 27 F.R. 2986, Mar. 30, 1962, effective May 3, 1962; [Amendment 4b-13, published 27 F.R. 12925, Dec. 29, 1962, effective Dec. 20, 1962.]

**4b.12 *Recording of applicable regulations.*** The Administrator, upon the issuance

of a type certificate, shall record the applicable regulations with which compliance was demonstrated. Thereafter, the Administrator shall record the applicable regulations for each change in the type certificate which is accomplished in accordance with regulations other than those recorded at the time of issuance of the type certificate. (See sec. 4b.11.)

**4b.13 *Type certificate.***

(a) An applicant shall be issued a type certificate when he demonstrates the eligibility of the airplane by complying with the requirements of this part in addition to the applicable requirements in Part 1 of this subchapter.

(b) The type certificate shall be deemed to include the type design (see sec. 4b.14 (b)), the operating limitations for the airplane (see sec. 4b.700), and any other conditions or limitations prescribed by the regulations in this subchapter.

(c) The applicable provisions of this part recorded by the Administrator in accordance with section 4b.12 shall be considered as incorporated in the type certificate as though set forth in full.



**4b.14 Data required.**

(a) The applicant for a type certificate shall submit to the Administrator such descriptive data, test reports, and computations as are necessary to demonstrate that the airplane complies with the requirements of this part.

(b) The descriptive data required in paragraph (a) of this section shall be known as the type design and shall consist of such drawings and specifications as are necessary to disclose the configuration of the airplane and all the design features covered in the requirements of this part, such information on dimensions, materials, and processes as is necessary to define the structural strength of the airplane, and such other data as are necessary to permit by comparison the determination of the airworthiness of subsequent airplanes of the same type.

**4b.15 Inspections and tests.** Inspections and tests shall include all those found necessary by the Administrator to insure that the airplane complies with the applicable airworthiness requirements and conforms to the following:

(a) All materials and products are in accordance with the specifications in the type design.

(b) All parts of the airplane are constructed in accordance with the drawings in the type design.

(c) All manufacturing processes, construction, and assembly are as specified in the type design.

**4b.16 Flight tests.** After proof of compliance with the structural requirements contained in this part, and upon completion of all necessary inspections and testing on the ground, and proof of the conformity of the airplane with the type design, and upon receipt from the applicant of a report of flight tests performed by him, the following shall be conducted:

(a) Such official flight tests as the Administrator finds necessary to determine compliance with the requirements of this part.

(b) After the conclusion of flight tests specified in paragraph (a) of this section, such additional flight tests as the Administrator finds necessary to ascertain whether there is reasonable assurance that the airplane, its components, and equipment are reliable and function properly. The extent of such additional flight tests shall depend upon the complexity of the

airplane, the number and nature of new design features, and the record of previous tests and experience for the particular airplane type, its components, and equipment. If practicable, these flight tests shall be conducted on the same airplane used in the flight tests specified in paragraph (a) of this section.

**4b.16-1 Applicant's flight test report** (*FAA policies which apply to sec. 4b.16*). The applicant should submit a report signed by his test pilot containing the results of flight tests which were conducted by him. It should certify that the airplane has been flown at least in all maneuvers necessary for proof of compliance with the flight requirements and it is his belief that the airplane will conform therewith. In the case of very large airplanes, this procedure may be modified as deemed necessary by the Administrator.

(19 F. R. 4446, July 20, 1954, effective Sept. 1, 1954.)

**4b.16-2 Preflight test planning** (*FAA policies which apply to sec. 4b.16 (a)*).

(a) *Proposed official flight test program.* Before the airplane is presented for official type certification tests, the applicant should submit to the FAA a proposed flight test program which will indicate at least the following:

(1) The area, defined by the several selections described in section 4b.100-2, which is to be covered by the terms of the type certification.

(2) All proposed tests; the order in which they are to be conducted; the purpose of each test; and for each the airplane weight, c. g. position, flap setting, power to be drawn, and, where appropriate, the altitude, the trim speed(s) and the speed(s) or speed range to be investigated. Appendix B presents a list of most of the flight and operation tests generally required for the type certification program together with information relative to the airplane configuration, test procedure, and special instrumentation for each test.

(3) Since most transport airplanes undergo many changes during their life span it is well to consider this fact in setting up a flight test program. Such changes as installation of different propellers, higher powered engines, etc., can often be predicted in advance.

(4) It is often desirable to simulate operation with higher power for the determination of

flying qualities and other tests, thus simplifying the problem of approving the airplane when the power change becomes effective. Data of this nature obtained during FAA flight tests may often reduce further testing during the life of the airplane.

(5) When an airplane has been type certificated in the transport category and a change is made affecting performance and/or flying qualities, the following procedure is suggested:

(i) The effect of the change on each of the flight tests in the general flight program should be noted.

(ii) Those tests which are materially influenced by the change should be listed.

(iii) A test program should be prepared embodying such of these tests as are felt to be critical or representative. This program should be forwarded to the FAA with the reasons for selecting the pertinent items. Appendix C shows representative flight programs for various types of changes and may be helpful in the preparation of the programs.

(iv) A description should be submitted of the method(s) which the applicant purposes to use in order to reduce the observed data to standard conditions.

(v) A statement should be submitted of any intention on the part of the applicant to resort to calculation in lieu of, or for the purpose of generalizing test data, together with a description of the data upon which these calculations are to be based and the methods to be used therein.

(6) Since it will require time for the FAA to determine the adequacy of this entire program, it is strongly recommended that it be submitted as early as practicable, otherwise the commencement of the testing may be delayed.

(b) *Order of testing.* The Civil Air Regulations are so worded that the results of some flight tests have a definite bearing on the conduct of other tests. For this reason careful attention should be given to the order of testing. The exact order of testing will be determined only by considering the particular airplane and test program involved. Appendix E shows a general arrangement that may be of assistance to those applicants who are not familiar with the FAA flight test procedures.

Tests which are particularly important in the early stages of the program are:

(1) *Airspeed calibration.* All tests involving airspeed depend upon the calibration.

(2) *Stall speed measurement.* Most of the performance tests and flying qualities are related to the stall speed.

(3) *Minimum control speed for takeoff.* The takeoff safety speed depends upon this item.

(4) *Engine cooling.* All en route climb speeds and cowl flap settings are related to this test.

(c) *Test groupings.*

(1) *Weight and c. g.* In addition to the regulatory relation of one test to another, efficient testing requires that consideration be given to the accomplishment of as many tests on a single flight as can be accommodated successfully. The tests shown in Appendix E have been grouped under various weight and center of gravity conditions in order to facilitate the development of a flight test program.

(2) *Special instrumentation.* Similarly, consideration should be given to grouping of tests that involve special instrumentation. Examples of these are takeoff and landing tests which usually require ground equipment to record horizontal distance, height, and time. Ground calibration of the airspeed indicating system can be accomplished at the same time. The FAA possesses certain instruments which may be used for obtaining test data, such as trailing airspeed bombs, sensitive altimeters, stop watches, carbon monoxide indicators, etc., as well as photographic equipment for measuring takeoff and flight landing paths. It is therefore recommended that the matter of instrumentation be discussed with the FAA before any decision is made with regard to the detailed flight test program. A list containing those tests requiring special instrumentation is shown in Appendix F.

(3) *Data reduction.* If the overall elapsed time for the certification program is to be kept to a minimum, tests requiring considerable data reduction should be conducted as early in the program as possible. Most performance data, particularly landing and takeoff data, fall in this category.

(19 F. R. 4446, July 20, 1954, effective Sept. 1, 1954.)

4b.16-3 *Additional flight tests (FAA policies which apply to sec. 4b.16 (b)).*

(a) *General.*

(1) At the option of the applicant, the flight tests specified in Civil Aeronautics Manual 1.77-4 for the ferry flight of a four-engine airplane with one engine inoperative may be conducted during the flight tests for type certification. Routine CAR tests as prescribed in sections 4b.100 through 4b.743 will be conducted (in accordance with existing procedures) to determine performance, flying qualities, power plant characteristics, etc.

(2) The official functional and reliability tests will be that portion of the tests conducted under the immediate supervision of the Type Certification Board,<sup>1</sup> as prescribed in paragraphs (c) through (h) of this section, to show compliance with sections 4b.100 through 4b.743.

(3) Supplementary experience consisting of other flight tests and experience with an airplane (of the same) type will be taken into consideration in establishing the extent of the official portions of the tests. This supplementary experience may be obtained by the manufacturer, military services, airlines, etc.

(4) Simulated tests consisting of tests on the ground or in an airplane of (like) components and equipment under conditions simulating those likely to be obtained in service will also be taken into consideration in establishing the extent of the official portion of the tests.

(b) *Functional and reliability tests.* In order to satisfactorily accomplish the objectives of section 4b.16 (b) concerning additional flight tests and the extent thereof, the Administrator deems it necessary that:

(1) A comprehensive and systematic check be made in flight of the operation of all components to determine whether they "function properly," i. e., perform their intended function without introducing safety hazards.

(2) Sufficient testing and supplementary experience under actual, or a combination of simulated and actual experience, be obtained and evaluated to give reasonable assurance that the airplane is "reliable," i. e., should continue to function properly in service. (In order to

obtain wider experience, manufacturers are encouraged to cooperate with airlines or other responsible operators in operating experimental airplanes of the same type under service conditions.)

(3) Appropriate corrective action be taken when the need therefor is determined under subparagraphs (1) and (2) of this paragraph. (The FAA is concerned only to the extent that the airplane can be operated safely under suitable inspection and maintenance procedures, but is not concerned with maintenance costs.)

(c) *Test program.* The Type Certification Board for each project will decide upon a proposed official test program at the time of the preflight meeting of the Board (prior to the routine CAR flight tests) and coordinate this with the airplane manufacturer. At the conclusion of the routine type tests, the T. C. Board will meet again to review the experience gained in those tests, changes made in the design and any additional supplementary experience, and to revise the proposed test program accordingly.

(d) *Planning and execution of test program.* The following points should be considered:

(1) The test program should be sufficiently well planned to enable its execution in an efficient manner without overlooking important items. It is not intended that the "paper work" be overemphasized to the detriment of the practical results, and it should be reduced to a minimum for small simple airplanes. The T. C. Board will review the design features and equipment with respect to the general objectives, and prepare a list showing:

(i) Components and systems to be checked in subparagraph (4) of this section.

(ii) A brief description of the operations to be performed, where these are not obvious (referencing any necessary operating instructions),

(iii) Special checks or likely critical conditions,

(iv) Estimated flight time required.

(2) Allowance may be made for the functional tests already required by the routine type tests. Allowance may also be made for simulated testing of new features and equipment; however, the flight test program should be planned to determine the adequacy of the

<sup>1</sup> A Type Certification Board is set up by the FAA field offices on each new type aircraft project.

simulated tests (e. g., to determine whether the actual environmental conditions of temperature,<sup>2</sup> vibration, etc., are covered by the simulated tests) when these may be critical, and to determine whether the installation and connected systems are satisfactory. The T. C. Board will then make a consolidated estimate of the total flight time required, allowing for overlapping, and adjust this in accordance with the "Test time" outlined in paragraph (e) of this section.

(3) The program will be arranged to permit the Flight Test Inspector in charge to become thoroughly familiar with the flying qualities of the airplane, particularly those not specifically covered in the routine type tests.

(4) All components of the airplane should be intensively operated and studied under all operating conditions expected in service and obtainable within the time and geographic limitations of the tests. Intensive operation means repeated operation of components in various sequences and combinations likely to occur in service. Particular attention should be given to potential sources of crew error, overtaxing of crew ability and the emergency procedures that would be required in the event of malfunction of any component. This intensive type of testing should be conducted in all cases, but the length of time for which it is continued will depend upon the simulated and supplementary experience available for the particular type, as outlined in "Test time" in paragraph (e) of this section.

(5) Ground inspections should be made at appropriate intervals during the test program to determine whether there are any failures or incipient failures in any of the components which might be a hazard to safe flight.

(6) When design changes are made during the course of the test, or when the official test airplane differs from those on which supplementary experience is obtained, or from modified versions of the same basic airplane type, the revised or modified items should be rechecked in accordance with the above procedure, but every effort should be made to include such

items in the program in such a way as to avoid unduly extending the overall test time. To this end, the Administrator may accept, in lieu of additional flight tests:

(i) Special tests of the original and revised components in which the conditions causing failure are intensified and

(ii) Simulated tests of differing components.

(e) *Test time.* It is highly desirable that functioning and reliability test programs be administered uniformly so that the program and flight time for a given project would be approximately the same regardless of which T. C. Board administered the project. This is difficult to achieve without establishing fixed arbitrary test times which would obviously be contrary to the intent of section 4b.16 (b). The following procedure which permits considerable flexibility is, therefore, established for the guidance of T. C. Boards.

(1) When supplementary experience is not taken into account and the airplane is conventional in regard to complexity and design features, the functioning and reliability test programs should be 150 hours. This time may be reduced to allow for simulated testing (see paragraph (d) (2) of this section), and for supplementary experience (see subparagraph (2) of this paragraph). However it may be necessary to increase the 150 hours, if difficulties are encountered in earlier flights, or for radically new design features or in extreme cases of complexity. An example of extreme complexity would be an airplane intended for operation at 40,000 ft. altitude, with automatic dive recovery flaps, turbos, variable jet exhaust, two-speed cooling fans, retractable wind screens, automatic control of engine cooling, turbos, intercoolers, jet exhausts, etc. The test program for such an airplane might require as much as 300 hours if no supplementary experience were available.

(2) When satisfactory supplementary experience is available and taken into account, the following allowances should be used as a guide and applied with judgment in reducing the official flight test time. However, in any case, the official program should provide sufficient time to accomplish the objective of paragraph (b) (1) of this section in accordance with the

<sup>2</sup> This does not imply that flight tests must be conducted under the most severe outside air temperatures likely to be encountered in service. It should normally be possible to determine the effects of extreme outside temperatures on local temperatures by extrapolation or by suitable correction factors.

items listed in paragraph (d) (3) and (4) of this section.

(i) *For intensive experience.* When the allowance is based on the total time of any one airplane in airline crew training and similar intensive operations, two hours of such operation may be considered equivalent to one hour of official testing.

(ii) *For miscellaneous experience.* When the allowance is based on the total time of any one airplane, five hours of such experience may be considered equivalent to one hour of official testing.

(iii) *Reduction for supplementary experience.* Whenever a reduction of official test time is desired on the basis of supplementary experience, such experience should be adequately recorded and submitted to the T. C. Board as described in paragraph (f) of this section.

(f) *Reports and records.*

(1) A log should be kept of all flight tests, and accurate and complete records kept of the inspections made and of all defects, difficulties, and unusual characteristics and sources of crew error discovered during the tests, and of the recommendations made and action taken. Items for which design changes may be required will be reported to the manufacturer and the appropriate FAA engineering division.

(2) If supplementary experience is to be taken into account, similar records of such experience should be kept and submitted to the T. C. Board, together with a list of the differences between the airplane on which the experience was obtained and the official test airplane. When supplementary experience is obtained on a large fleet of airplanes (for example, military operations) of the same or a comparable type (see paragraph (d) (6) of this section), these records may consist of statistical summaries in lieu of complete records for each individual airplane.

(3) At the conclusion of the official tests, a summary report should be prepared by the T. C. Board and forwarded to Washington for inclusion in the Type Inspection Report.

(g) *Administration.* The FAA Flight Test Inspector in charge will act as coordinator of all flight activities of the T. C. Board during the official program and the agent or an alternate

designated by him will participate in all flights. He will collaborate with the manufacturers' pilots in all these activities, particularly in regard to flight plans and procedures. The manufacturers' pilots should be in command of all flights, but FAA pilots will fly the airplane at least sufficiently to accomplish paragraph (d) (3) of this section.

(1) Other FAA personnel (e. g., representatives of other divisions and specialists) will participate in the flight tests when deemed necessary by the T. C. Board to accomplish the purposes of the tests.

(2) When supplementary experience is obtained in airline operations, an FAA Flight Standards Service Inspector will be assigned to follow the operations, review the operator's records, and supplement these by reports to the T. C. Board.

(h) *Test airplane.* To facilitate completion of the type certification procedure one airplane may be used for the official functioning and reliability tests while another airplane (or airplanes) is used for the routine type tests. In this case the test time on at least one airplane should be sufficient to accomplish the objective of paragraph (b) (2) of this section.

(i) *Modified types.* The procedure outlined in (h) applies to new type designs. When a design employs components identical to those used in previous designs, credit may be given for the supplementary experience available for such components. When a design is modified (for example, several versions of the same basic type with different engines, propellers, etc.), the modified features and components should be treated in accordance with paragraph (d) (6) of this section.

(19 F. R. 4447, July 20, 1954, effective Sept. 1, 1954, amended 20 F. R. 6677, Sept. 10, 1955, effective Sept. 30, 1955.)

4b.16-4 *Flight tests (FAA policies which apply to sec. 4b.16).* The policies outlined in section 4b.402-1 (c) and section 4b.402-1 (l) (3) will apply.

(20 F. R. 2279, Apr. 8, 1955, effective Apr. 30, 1955.)

**4b.17 Airworthiness, experimental, and production certificates.** (For requirements with regard to these certificates see Part 1 of this subchapter.)

**4b.18 Approval of materials, parts, processes, and appliances.**

(a) Materials, parts, processes, and appliances shall be approved upon a basis and in a manner found necessary by the Administrator to implement the pertinent provisions of the regulations in this subchapter. The Administrator may adopt and publish such specifications as he finds necessary to administer this regulation, and shall incorporate therein such portions of the aviation industry, Federal, and military specifications respecting such materials, parts, processes, and appliances as he finds appropriate.

NOTE: The provisions of this paragraph are intended to allow approval of materials, parts, processes, and appliances under the system of Technical Standard Orders, or in conjunction with type certification procedures for an airplane, or by any other form of approval by the Administrator.

(b) Any material, part, process, or appliance shall be deemed to have met the requirements for approval when it meets the pertinent specifications adopted by the Administrator, and the manufacturer so certifies in a manner prescribed by the Administrator.

4b.18-1 *Approval of aircraft materials, parts, processes, and appliances (FAA rules which apply to sec. 4b.18).* Aircraft materials, parts, processes and appliances made the subject of Technical Standard Orders shall be approved upon the basis and in the manner prescribed in Part 514<sup>3</sup> of the Regulations of the Administrator, "Technical Standard Orders—C Series—Aircraft Components."

(17 F. R. 10101, Nov. 7, 1952, effective Dec. 1, 1952.)

4b.18-2 *Application of Technical Standard Orders—C Series (FAA policies which apply to sec. 4b.18).*

(a) *Purpose of Technical Standard Orders.* Technical Standard Orders are a means by which the Administrator adopts and publishes the specifications for which authority is provided in section 4b.18 (a) of this chapter.

(b) *Applicability of Technical Standard Order Requirements.*

(1) The applicability of and effective dates for TSO'd items are set forth in each TSO.

(2) Each Technical Standard Order sets forth the conditions under which materials, parts, processes and appliances approved by the Administrator prior to establishment of an applicable TSO, may continue to be used in aircraft.

(3) The establishment of a Technical Standard Order for any product does not preclude the possibility of establishing the acceptability of a similar product as part of an aircraft, engine or propeller, under the type certification or modification procedures, if there is established a level of safety equivalent to that provided in the Civil Air Regulations as implemented by the appropriate Technical Standard Order and the product is identified as a part of the airplane, engine or propeller.

(c) *Administration of the Technical Standard Order (TSO) System.* The principles which apply in administering the Technical Standard Orders system are as follows:

(1) Technical Standard Orders will reference performance provisions of recognized government specifications, or established industry specifications which have been found acceptable by the FAA. If no satisfactory specification exists, the Orders will include criteria prepared by the Administrator. In preparing criteria of this type, the Administrator will give consideration to recommendations made by the industry.

(2) Minimum performance requirements established by the Federal Aviation Agency and published in Technical Standard Orders will serve as a means by which materials, parts, processes, and appliances intended for use in certificated aircraft will be accepted.

(3) TSO's set forth the minimum requirements for safety. Every effort will be made by the FAA to keep the requirements at the minimum levels of safety, and TSO's will not be used to set forth "desirable" standards.

(4) It will be the responsibility of the person submitting a statement of conformance to the FAA, certifying that his product meets the requirements of the TSO, to conduct the necessary tests demonstrating compliance therewith. This person will be held responsible for maintaining quality control adequate to assure that products which he guarantees to meet the requirements of a TSO do, in fact, meet these

<sup>3</sup> Part 514 and copies of individual TSO's are available upon application to the Publishing and Graphics Branch, Attn: MS-158, Federal Aviation Agency, Washington 25, D.C.

standards. The FAA will not formally approve such products as meeting the requirements of TSO's nor exercise direct inspection control over them. The statement of conformance with the provisions of a Technical Standard Order normally will be accepted by the FAA as sufficient indication that the applicable requirements have been fulfilled. Any TSO'd item which is modified must continue to comply with the requirements of the TSO, and the person authorizing the modification will be responsible for such compliance.

(d) *Numbering of Technical Standard Orders.* Each Technical Standard Order will be assigned a designation consisting of the letters "TSO," a series code letter "C", indicating aircraft materials, parts, processes, or appliances and a serial number to be assigned in sequence for each of the TSO's issued in the "C" series, e. g., TSO-C-1, "Smoke Detectors." Revisions are indicated by the addition of letters a, b, c, etc., after the number.

(17 F. R. 10101, Nov. 7, 1952, effective Dec. 1, 1952.)

4b.18-3 *Manufacturer (FAA interpretation which applies to sec. 4b.18 (b)).*

(a) For the purpose of accepting a statement of conformance for a Technical Standard Order product, the word "manufacturer" is interpreted to mean a person who fabricates, or both fabricates and assembles, a product by cutting, drilling, bolting, riveting, gluing, soldering, sewing, or other fabrication and assembly techniques.

(b) A person is not regarded as the manufacturer solely by his engaging in the following activities:

(1) Distributing a completed product fabricated or fabricated and assembled by another person.

(2) Cleaning and reassembling products, repairing products, or replacing components or parts in products.

(23 F. R. 10325, Dec. 25, 1958, effective Jan. 31 1959.)

4b.18-4 *Approval of products under the type certificate or modification procedures (FAA policies which apply to sec. 4b.18(b)).* A material part, process, or appliance (hereinafter called "product") may be approved as a part

of the airplane type design under a type certificate or a supplemental type certificate in accordance with the procedures provided in this section.

**EXPLANATORY NOTE:** Products previously approved by the CAA by means of letters of approval, Repair and Alteration Form ACA-337, or listing on CAA Product and Process Specifications will continue to be eligible for installation in aircraft unless the eligibility is restricted by applicable regulations or airworthiness directives issued under section 1.24 of this subchapter.

(a) *Policies controlling where there is an applicable Technical Standard Order.* If a Technical Standard Order covering the product is in effect, the applicant for approval should submit type design data showing that the product meets the performance standards of the Technical Standard Order. Deviations from such performance standards may be allowed to the extent that the applicant for the type certificate or the supplemental type certificate substantiates that certain provisions of the Technical Standard Order are not required for the product as installed in the airplane.

(b) *Policies controlling in the absence of an applicable Technical Standard Order.* Where no TSO covering the product exists, the applicant for approval should submit type design data showing compliance with all the requirements of this part which are applicable to the product. Any deviation from standards prescribed in this part may be allowed only in accordance with section 4b.10.

(c) *Methods of identifying products approved under this section.*

(1) Products approved as a part of the airplane type design under a type certificate should be identified by an airplane part number on the approved drawing list.

(2) Products approved as a part of the airplane type design under a supplemental type certificate should be identified by a part or drawing number on such certificate.

(3) Each TSO product that is approved as a part of the airplane should have the TSO identification removed and be identified as set forth in subparagraph (1) or (2) of this paragraph, whichever is applicable.

(23 F. R. 10325, Dec. 25, 1958, effective Jan. 31, 1959.)

**4b.19 Changes in type design.** (For requirements with regard to changes in type design and the designation of applicable regula-

tions therefor, see sec. 4b.11 (d) and (e), and Part I of this subchapter.)

## Subpart B—Flight

### General

#### 4b.100 Proof of compliance.

(a) Compliance with the requirements prescribed in this subpart shall be established by flight or other tests conducted upon an airplane of the type for which a certificate of airworthiness is sought or by calculations based on such tests, provided that the results obtained by calculations are equivalent in accuracy to the results of direct testing.

(b) Compliance with each requirement shall be established at all appropriate combinations of airplane weight and center of gravity position within the range of loading conditions for which certification is sought by systematic investigation of all these combinations, except where compliance can be inferred reasonably from those combinations which are investigated.

(c) The controllability, stability, trim, and stalling characteristics of the airplane shall be established at all altitudes up to the maximum anticipated operating altitude.

(d) The applicant shall provide a person holding an appropriate pilot certificate to make the flight tests, but a designated representative of the Administrator shall pilot the airplane when it is found necessary for the determination of compliance with the airworthiness requirements.

(e) Official type tests shall be discontinued until corrective measures have been taken by the applicant when either:

(1) The applicant's test pilot is unable or unwilling to conduct any of the required flight tests, or

(2) It is found that requirements which have not been met are so substantial as to render additional test data meaningless or are of such a nature as to make further testing unduly hazardous.

(f) Adequate provision shall be made for emergency egress and for the use of parachutes by members of the crew during the flight tests.

(g) The applicant shall submit to the Administrator's representative a report covering

all computations and tests required in connection with calibration of instruments used for test purposes and correction of test results to standard atmospheric conditions. The Administrator's representative shall conduct any flight tests which he finds necessary to check the calibration and correction report.

(17 F. R. 10101, Nov. 7, 1952, effective Dec. 1, 1952.)

4b.100-1 Procedure for demonstrating compliance with the flight requirements (FAA policies which apply to sec. 4b.100 (a)).

(a) *Responsibility.* The burden of showing or implementing compliance with the requirements for an airworthiness or a type certificate rests with the applicant. The applicant should at his own expense and risk, conduct such official flight tests as determined by the FAA to demonstrate compliance with the minimum requirements. During the type inspection the applicant should make available the airplane for that purpose as well as all of the personnel and equipment necessary to obtain the required data.

(b) *Tolerances permitted for flight tests.*

(1) *General.* The tolerances in (b). (2) of this section are the allowable deviation from specified flight conditions for a particular test. They are not allowable tolerances on specific requirements, nor are they to be considered as allowable inaccuracy of measurement or of the method of determination. As an example, when demonstrating stability with specified trim speed of  $1.4 V_{s1}$ , the trim speed may be  $1.4 V_{s1} \pm 3$  m. p. h. or 3 percent; however, no positive tolerance is permitted when demonstrating the minimum prescribed trim speed of  $1.4 V_{s1}$ .

(i) Where variation in the parameter on which a tolerance is allowed will have an appreciable effect on the test, the result should be corrected to the standard value of the parameter; otherwise, no correction is necessary. The applicant may adhere to closer tolerances if he so desires.



(ii) The following list indicates the cases in which correction for tolerances should be made:

Test	Weight	C. G.	Air speed	Power	Wind
Airspeed calibration					
Stall speeds	X				
All climbs	X			X	
Landings	X		X		X
Takeoff	X		X	X	X
Accelerate	X		X	X	X
Decelerate	X		X		X
Stability and control					
Minimum control speed.				X	

(2) *Individual tolerances.* The following are general tolerances from specified values permitted during FAA testing. These tolerances apply unless, for a particular test, other tolerances are set forth in the testing procedure. These tolerances are plus or minus variations unless otherwise noted in the particular test:

Item	Tolerance
Weight	+5%, -10%
Critical items affected by weight	+5%, -1%
C. G.	7% total travel
Airspeed	3 m. p. h. or $\pm 3\%$ whichever is greater
Power	5%
Wind (takeoff and landing tests)	As low as possible but not to exceed approximately 12% $V_{S1}$ or 12 m. p. h., whichever is lower, along the runway—measured at a height of 6 feet above the runway surface.

(c) *Type Inspection Report.*

(1) All information and data obtained as a result of the type inspection investigation and tests should be reported in Form FAA 283-4b, Type Inspection Report.

(2) Upon completion of the type inspection, the applicant should prepare the information necessary to show compliance with the requirements. This material together with the

Airplane Flight Manual required by section 4b.740 should be completed as promptly as possible and forwarded to the FAA.

(19 F. R. 4448, July 20, 1954, effective Sept. 1, 1954.)

4b.100-2 *Selection of weight, altitudes, speeds and wing flap positions (FAA policies which apply to sec. 4b.100 (b)).* Before starting official flight tests, certain data should be obtained by the applicant in order that the options prescribed in paragraphs (a) through (e) of this section can be executed:

(a) *The selection of the range of weight and altitude to be covered by the flight testing required for certification.* This selection should be based upon the extent to which the applicant for certification is concerned with the operating limitations which will be imposed upon the airplane. If the applicant is not concerned with this point, he may elect to conduct only the flight tests required to demonstrate compliance with the minimum performance requirements contained in section 4b.110 together with those required to demonstrate compliance with the flying qualities and other requirements specified in sections 4b.130 through 4b.190. If it is practicable to limit the operation of the airplane by a scheduled air carrier to sea level airports containing runways of ample length and to terrain altitude not in excess of 4,000 feet, this procedure appears satisfactory. It should be noted that this case could apply to a seaplane in scheduled operation. If the applicant wishes to provide for the greatest possible flexibility in the matter of compliance with the operating limitations contained in section 40.70 of this subchapter, considerably more performance tests will be necessary. It may be entirely practicable, for example, for operation over routes involving appreciable differences in the altitude of airports, to take advantage of the improvement in performance which is possible by means of reducing the weight at which the airplane is operated. It may also be desirable to alter the various flap settings in order to improve the climbing performance at a given weight. In cases such as these, it will be necessary to determine by flight testing and calculation, the effect of weight, altitude, and flap setting, throughout the range of each for which it is desired to provide, upon the takeoff, landing, and climbing performance and to in-

clude this information in the FAA Approved Airplane Flight Manual. This selection will be left to the applicant since, even though he may find it difficult to anticipate the uses to which the airplane may subsequently be put, he is nevertheless in better position to forecast this than anyone else.

(b) *The selection of the weight range to be covered by the terms of the certification.* This selection is closely related to paragraph (a) of this section and should be based upon essentially the same considerations. The simplest possible selection of weights is a single maximum weight to be used both for takeoff and landing and as a basis for the operating limitations. The next simplest choice would appear to be a maximum takeoff weight and a maximum landing weight differing from takeoff weight. This choice requires the installation of fuel jettisoning equipment (when the takeoff weight exceeds the landing weight by more than 5 percent) of sufficient capacity to reduce the weight of the airplane from the maximum takeoff weight to the maximum landing weight in compliance with section 4b.437. The operating limitations may then be based upon the assumption that these two weights exist throughout each flight. The most flexible possible arrangement in the matter of weights is provided by selecting a range of weights for takeoff and a range for landing, and determining the performance as functions of these weights so that, in showing compliance

with the operating limitations, any weight within these ranges may be selected to fit the requirements of a particular route. This selection should be left with the applicant.

(c) *The selection of the range of altitude to be covered by the terms of the certification.* This selection is also closely related to paragraph (a) of this section and is analogous in its nature to paragraph (a) of this section. The simplest possible selection is that indicated by the minimum performance requirements contained in section 4b.110, namely, sea level for the purposes of the determination of the takeoff and landing distances and certain of the rates of climb at 5,000 feet for the purpose of determining the en route rates of climb. The selection providing the greatest possible flexibility is the one in which these items of performance are determined for a range of altitude great enough to cover all anticipated routes over which the airplane may be operated.

(d) *The selection of the wing flap positions desired for certification.* Policies outlined in section 4b.111-1 will apply to this selection.

(e) *The selection of the critical speed<sup>4</sup> to be used in the determination of the takeoff distance.* Policies outlined in section 4b.113-2 will apply to this selection.

(19 F. R. 4449, July 20, 1954, effective Sept. 1, 1954.)

<sup>4</sup> The practical effect of the selection of this speed is that it permits the applicant to define in the type certificate the limits of airplane weight and airport altitude within which the airplane may be operated by a scheduled air carrier in compliance with Part 40 of this subchapter.

### Discussion of Policies Relating to Flying Qualities in Section 4b.100-3

The relation between flying qualities (controllability, stability, trim, stalling characteristics) and safety involves the level of skill and the degree of attention required on the part of the pilot to fly the airplane. It is theoretically possible to design an airplane which cannot be flown by a single pilot because, for example, he may not have enough strength, or alternatively a sufficiently delicate touch, to operate the controls or there may be so many necessary operations that he cannot perform all of them within the required time. The flight tests pertaining to flying qualities are specified in sections 4b.130 through 4b.133, sections 4b.140 through 4b.144, sections 4b.150 through 4b.158, sections 4b.160 through 4b.162 and sections 4b.170 and 4b.171. These requirements cover the more important characteristics and loading conditions which have been agreed to be critical or representative of flight regimes. If the airplane passes the tests no investigation of other loading conditions will ordinarily be required.

4b.100-3 *Flying qualities (FAA policies which apply to sec. 4b.100 (c)).*

(a) It should be possible to operate the airplane safely at all anticipated altitudes without requiring exceptional attention and skill by the pilot or appropriate crew members.

(b) If there is less than 2 m. p. h. difference in the forward and rearward c. g. stalling speeds, all flying qualities may be based upon the forward c. g. stalling speeds. Otherwise, the stalling speed appropriate to the c. g. position should be used.

(c) If there is reason to believe that any of the flying qualities would be affected by altitude, they should be investigated for the most adverse altitude condition expected in normal operation.

(19 F. R. 4449, July 20, 1954, effective Sept. 1, 1954.)

**4b.101 *Weight limitations.*** The maximum and minimum weights at which the airplane will be suitable for operation shall be established as follows:

(a) Maximum weights shall not exceed any of the following:

(1) The weight selected by the applicant;

(2) The design weight for which the structure has been proven;

(3) The maximum weight at which compliance with all of the applicable flight requirements has been demonstrated.

(b) It shall be acceptable to establish maximum weights for each altitude and for each practicably separable operating condition (e. g., takeoff, en route, landing).

(c) Minimum weights shall not be less than any of the following:

(1) The minimum weight selected by the applicant;

(2) The design minimum weight for which the structure has been proven;

(3) The minimum weight at which compliance with all of the applicable flight requirements has been demonstrated.

**4b.102 *Center of gravity limitations.*** Center of gravity limits shall be established as the most forward position permissible and the most aft position permissible for each practicably separable operating condition in accordance with section 4b.101 (b). Limits of

the center of gravity range shall not exceed any of the following:

(a) The extremes selected by the applicant;

(b) The extremes for which the structure has been proven;

(c) The extremes at which compliance with all of the applicable flight requirements has been demonstrated.

**4b.103 *Additional limitations on weight distribution.*** If a weight and center of gravity combination is permissible only within certain load distribution limits (e. g., spanwise) which could be exceeded inadvertently, such limits shall be established together with the corresponding weight and center of gravity combinations, and shall not exceed any of the following:

(a) The limits selected by the applicant;

(b) The limits for which the structure has been proven;

(c) The limits for which compliance with all the applicable flight requirements has been demonstrated.

**4b.104 *Empty weight.***

(a) The empty weight and the corresponding center of gravity position shall be determined by weighing the airplane. This weight shall exclude the weight of the crew and payload, but shall include the weight of all fixed ballast, unusable fuel supply (see sec. 4b.416), undrainable oil, and total quantity of hydraulic fluid.

(b) The condition of the airplane at the time of weighing shall be one which can be easily repeated and easily defined, particularly as regards the contents of the fuel and oil tanks, and the items of equipment installed.

**4b.105 *Use of ballast.*** It shall be acceptable to use removable ballast to enable the airplane to comply with the flight requirements. (See secs. 4b.738 and 4b.741 (c).)

(19 F. R. 4449, July 20, 1954, effective Sept. 1, 1954.)

**4b.105-1 *Use of ballast during flight tests (FAA policies which apply to sec. 4b.105).*** Ballast should be carried during the flight tests whenever it is necessary to simulate pay load. Consideration should be given to the vertical as well as horizontal location of the ballast in cases where it may have an appreciable effect on the performance or flying qualities of the

airplane. The strength of the supporting structures should be adequate to preclude their failure as a result of the flight loads that may be imposed during the tests.

(19 F. R. 4449, July 20, 1954, effective Sept. 1, 1954.)

## Performance

### 4b.110 General.

(a) With respect to all airplanes type certificated on or after February 12, 1951, the performance prescribed in this subpart shall be determined, and compliance shall be shown, for standard atmospheric conditions and still air, except that the performance as affected by engine power, instead of being based on dry air, shall be based on 80 percent relative humidity.

(b) Each set of performance data required for a particular flight condition shall be determined with the powerplant accessories absorbing the normal amount of power appropriate to that flight condition. (See also sec. 4b.117.)

4b.110-1 *Engine power corrections (FAA policies which apply to sec. 4b.110).*

(a) *Engine power corrections for vapor pressure.* The following standard vapor pressures, specific humidities, and densities versus altitude have been established for the purpose of correcting airplane performance data in accordance with section 4b.110.

ALTITUDE H (FL.)	VAPOR PRESSURE e (In. Hg.)	SPECIFIC HUMIDITY w (Lb. moisture per lb. dry air)	DENSITY RATIO $\frac{e}{0.0023769}$
0	0.403	0.00849	0.99508
1,000	.354	.00773	.96672
2,000	.311	.00703	.93895
3,000	.272	.00638	.91178
4,000	.238	.00578	.88514
5,000	.207	.00523	.85910
6,000	.1805	.00472	.83361
7,000	.1566	.00425	.80870
8,000	.1356	.00382	.78434
9,000	.1172	.00343	.76053
10,000	.1010	.00307	.73722
15,000	.0463	.001710	.62868
20,000	.01978	.000896	.53263
25,000	.00778	.000436	.44806

(b) *Engine power corrections for cylinder head temperatures.* Official flight tests should be discontinued whenever engine limitations

are exceeded. This procedure automatically makes corrections of this type unnecessary.

(c) *Engine power corrections for fuel flow.* Official flight tests should not be conducted when the metering characteristics of the carburetor are outside the range of acceptable tolerances. This procedure automatically makes corrections for fuel-air mixture ratio in performance evaluation unnecessary.

(19 F. R. 1817, Apr. 2, 1954, effective Apr. 2, 1954; amended 23 F. R. 7482, Sept. 26, 1958, effective Oct. 20, 1958.)

4b.110-2 *Engine power calibration (FAA policies which apply to sec. 4b.110).* The performance of an airplane established in accordance with the requirements of sections 4b.110 through 4b.125 and shown in the performance section of the Airplane Flight Manual should be reproducible by any airplane of a similar model having engines that deliver no more than 100 percent certificated rated power. This means that the power used to drive all accessories, other than those necessary to the functioning of the engine, should be deducted from the certificated rated or installed engine power, whichever is less. To assist in meeting these objectives, the engine power of all new type airplanes as defined by section 4b.11 (e) should be calibrated in accordance with paragraphs (a) through (c) of this section.

(a) *Corrections to the calibrated power for engines producing power above the certificated ratings.*

(1) The applicant should provide engine power output data obtained from dynamometer tests, or the equivalent thereof, for all engines that are installed in the airplane which will be used in the power calibration flight tests. The data should be sufficiently complete to allow a direct comparison with the approved certificated ratings of the engines.

(2) If the dynamometer calibration data for any engine selected for the inflight power calibration in accordance with the provisions of paragraph (b) of this section indicate that the power (based on standard atmospheric conditions for the engine) is higher than the certificated rating for the engine model, the calibrated power curve established as a result of flight tests in paragraphs (b) and (c) of this section should be corrected by applying the following power re-

duction: 100 percent of the power increment between the dynamometer calibration and the certificated engine rating at sea level, and 47 percent of the sea level power increment applied at an altitude of 20,000 feet with a lineal variation between these two points throughout the operating altitude range of the airplane. If the calibrated power curve established as a result of the flight tests represents an average power for more than one engine, it should be corrected by applying a power reduction equivalent to the average power difference between the dynamometer and the rated power for all engines used in the flight calibration tests. The application of other correction methods and values that will adjust the power data on the basis of the certificated rating of the engine throughout the operating altitude range of the airplane are acceptable if they can be substantiated.

(b) *Selection of engines for power calibration in flight.* With the exception of the critical inoperative engine, the number of engines which will be used as a basis for power calibration is left to the option of the applicant. However, the procedure specified in this paragraph should be followed to determine which engine(s) should be selected for establishing the basic calibrated power curve.

(1) The installed power of all engines should be compared in flight by means of calibrated torquemeters or other equivalent methods. If a calibrated power curve is to be established on the basis that all engine driven accessories will be in operation during flight, the comparison should be made under full accessory load conditions. If a separate calibrated power curve is to be established for application to those test configurations where certain accessories will not be in operation, the power of all engines may be compared when these accessories are in the appropriate idling or off position. In this case it will be necessary to provide data, indicating accessory load requirements for those flight configurations and the particular engine(s) from which the power is obtained.

(2) For two-engine aircraft it is only necessary to calibrate the engine which produces the lesser power determined by comparing the results of the torquemeter indications in accordance with subparagraph (1) of this paragraph for the most critical accessory load condi-

tion and taking into consideration the appropriate power reduction when the engine dynamometer test output is above the rated power for the engine. All performance data scheduled in the Airplane Flight Manual should be based on the calibrated power curve established for this engine. If the applicant desires to calibrate the power of both engines, only the all-engine-operating performance data should be based on a curve representing the average power for the two engines.

(3) When the applicant desires to calibrate the power of one engine for aircraft having more than two engines, the engine selected should be that which delivers the lowest power, determined by comparing the results similarly as in the case of the two-engine aircraft in subparagraph (2) of this paragraph. All performance data scheduled in the Airplane Flight Manual should be based on the calibrated power curve established for this engine. If the applicant desires to calibrate the power of two engines, the calibrated power curve should be based on values representing an average of the two engines delivering the lowest power.

(4) The procedure in subparagraph (3) of this paragraph should be followed if the applicant desires to calibrate the power of more than two engines, however, the Airplane Flight Manual performance data should be based upon an average calibrated power curve which has been derived from not more than the actual number of engines in operation corresponding to the test configuration for which performance is established. This procedure is not necessary, for example, in the case where the average power curve for two and three engines is substantially equal. However, the third engine may be calibrated to obtain additional data which will permit a more accurate fairing of the calibrated power curve.

(5) If the results of the flight tests indicate that the power of any engine selected in accordance with the provisions of this paragraph exceeds rated power after the application of the dynamometer correction specified in paragraph (a) of this section, the calibrated power curve for application to performance testing should be based upon not more than certificated rated power of the engine with the power to drive the accessories deducted.

(c) *Flight test procedure for calibrating engine power.* The engine calibration flight tests should be conducted in accordance with the provisions specified in this paragraph.

(1) The critical altitudes of the engine should be established for takeoff power and maximum continuous power providing these critical altitudes lie below the highest operating altitude desired for certification. Critical altitudes need not be determined above the maximum operating altitude of the airplane.

(2) For engine installations specifically designed to indicate power by means of torque-meters, the engine power calibration tests as well as all performance tests which are affected by power should be obtained with calibrated torque-meters.

(3) All engine adjustments such as ignition timing, valve clearances, air-fuel ratios, fuel flow rates, antidetonant injection flow rates, etc., should be maintained within approved limits for the engine. If any permanent changes are made to the engine or powerplant installation during the type certification tests, and such changes result in an engine power output less than that established in the calibrated power data, then all performance data should be corrected to this lower power.

(4) The engine power calibration tests should be conducted in an atmosphere which is free of any visible moisture.

(5) The engine power calibration tests should be conducted in the configurations that follow:

(i) *Takeoff power.*

Weight—maximum takeoff.

C. G. position—optional.

Wing flaps—takeoff position.

Landing gear—retracted.

Operating engine(s)—takeoff r. p. m. and manifold pressure or full throttle, mixture setting at normal position for takeoff power, carburetor air heat control at cold and cowl flaps in takeoff position (see sec. 4b.118-1 (d) (1)).

Critical inoperative engine—throttle closed on highest powered engine, propeller windmilling in takeoff pitch (may be feathered if automatic feathering device is installed),

mixture setting at idle cut-off and cowl flaps in takeoff position (see sec. 4b.118-1 (d) (1)).

(ii) *Maximum continuous power.*

Weight—maximum takeoff.

C. G. position—optional.

Wing flaps—en route position.

Landing gear—retracted.

Operating engine(s)—maximum continuous r. p. m. and manifold pressure or full throttle, mixture setting at normal position, carburetor air heat control at cold and cowl flaps at FAA hot day cooling position.

Critical inoperative engine—throttle closed on highest powered engine, propeller feathered and cowl flaps in minimum drag position.

(6) *Test procedure and required data.* The engine power calibration tests should be conducted in a climbing attitude at the takeoff safety speed,  $V_2$ , with the use of takeoff power and at the en route climb speed with the use of maximum continuous power. The climbs should be started at the lowest practicable altitude and cover the altitude range desired for certification. During these tests the engine(s) should be operated within the approved limits for r. p. m., manifold pressures, temperatures, etc. The following data should be recorded at reasonable time intervals for each power condition:

Pressure altitude.

Ambient air temperature.

Humidity.

Indicated air speed.

Engine(s), r. p. m. and manifold pressure.

Torque pressure.

Cylinder head temperatures.

Carburetor air temperature.

Fuel flow rate.

Antidetonant injection flow rate.

In addition a record should be made of the following items:

Fuel grade.

Wing flap position.

Landing gear position.

Cowl flap position.

Mixture setting.

Blower setting.

Accessory power loads and distribution.

(d) *Engine power checks.* A suitable means should be established by which engine power may be compared after overhauls with the original calibrated power data obtained as a result of the type certification tests.

(21 F. R. 8417, Nov. 3, 1956, effective Nov. 30, 1956.)

#### 4b.111 *Wing flap positions.*

(a) The wing flap positions denoted respectively as the takeoff, en route, approach, and landing positions shall be selected by the applicant. (See also sec. 4b.323.)

(b) It shall be acceptable to make the flap positions variable with weight and altitude.

4b.111-1 *Selection of the wing flap positions (FAA policies which apply to sec. 4b.111).*

(a) In the selection of the wing flap positions desired for certification, the flap position indicator should show flap up, takeoff, en route, approach, and landing positions. Various items of performance are required to be determined at each of these flap positions. Section 4b.120 (d) requires that the stalling speed with the flap in the "approach" position should not exceed 110 percent of the stalling speed with the flap in the "landing" position. No plans for flight testing should be made until these positions are selected unless the applicant wishes to investigate systematically the effect of flap position upon each of several of the items of performance which should be determined at the nominal position to be selected.

(b) The selection of multiple sets of wing flap positions is permitted in order to obtain optimum performance at various airports. However, it is recommended that the approval of multiple flap position settings for any one airplane be limited to two or at the most three.<sup>5</sup>

(c) A reasonable number of takeoff flap settings in excess of three may be approved for operation under Civil Air Regulations, Parts 40, 41, 42, and 43 of this chapter, if a dispatch procedure is established to provide per-

tinuous operating limitations for the particular takeoff involved.

(19 F. R. 4449, July 20, 1954, effective Sept. 1, 1954.)

#### 4b.112 *Stalling speeds.*

(a) The speed,  $V_{s0}$ , shall denote the calibrated stalling speed, or the minimum steady flight speed at which the airplane is controllable, in miles per hour, with:

(1) Engines idling, throttles closed (or not more than sufficient power for zero thrust at a speed not greater than 110 percent of the stalling speed);

(2) Propeller pitch controls in the position normally used for takeoff;

(3) Landing gear extended;

(4) Wing flaps in the landing position;

(5) Cowl flaps closed;

(6) Center of gravity in the most unfavorable position within the allowable landing range;

(7) The weight of the airplane equal to the weight in connection with which  $V_{s0}$  is being used as a factor to determine a required performance.

(b) The speed,  $V_{s1}$ , shall denote the calibrated stalling speed, or the minimum steady flight speed at which the airplane is controllable, in miles per hour, with:

(1) Engines idling, throttles closed (or not more than sufficient power for zero thrust at a speed not greater than 110 percent of the stalling speed);

(2) Propeller pitch controls in the position normally used for takeoff, the airplane in all other respects (flaps, landing gear, etc.) in the particular condition existing in the particular test in connection with which  $V_{s1}$  is being used;

(3) The weight of the airplane equal to the weight in connection with which  $V_{s1}$  is being used as a factor to determine a required performance.

(c) The stall speeds defined in this section shall be the minimum speeds obtained in flight tests conducted in accordance with the procedure of subparagraphs (1) and (2) of this paragraph.

(1) From a speed sufficiently above the stalling speed to assure steady conditions, the elevator control shall be applied at a rate such that the airplane speed reduction does not exceed one mile per hour per second. This

<sup>5</sup> The reason for recommending a limited number of flap settings is due to the increasing complexity of T-category operation with the increasing number of variables such as power ratings, takeoff flap settings and associated climb speeds, temperature accountability, etc., which are contained in the Airplane Flight Manual. Each additional set of flap positions approved increases the complexity with which the performance information in the Airplane Flight Manual can be evaluated to provide the proper level of safety, particularly in the takeoff flight stage.

maneuver shall be performed with the airplane trimmed at a speed of  $1.4 V_{S1}$ , except that airplanes utilizing adjustable stabilizers may be trimmed at a speed selected by the applicant but not less than  $1.2 V_{S1}$ , nor greater than  $1.4 V_{S1}$ .

(2) During the test prescribed in subparagraph (1) of this paragraph, the flight characteristics provisions of section 4b.160 shall be complied with.

4b.112-1 *Procedure for determining stalling speeds (FAA policies which apply to sec. 4b.112 (c)).*

(a) Since all performance requirements are based upon some function of the stalling speeds, accurate measuring methods and careful piloting technique should be employed during the tests required for determination of these speeds. The essential items to be considered when conducting tests to determine the stalling speeds are as follows:

(1) The airspeed system should have the same characteristics as outlined in section 4b.612-1 (a) (2). Preferably, an independent test airspeed system should be employed in measuring the stalling speeds such as a shielded or swivel impact pressure sensing head used in conjunction with a trailing static bomb. The airspeed system lag should be a minimum with the impact and static systems dynamically balanced to minimize the error associated with changing ambient pressure. With the above described airspeed system, the applicant may elect to use the minimum airspeed obtained during the maneuver, or may determine and apply the lag correction associated with changing airspeed (deceleration) to the minimum values obtained above. If the latter option is elected, the applicant should determine the correct lag factors to be applied under varying  $dV/dt$  conditions. If the airspeed system is not dynamically balanced, adequate corrections should be made.

(2) A satisfactory method of determining the correct lag associated with changing airspeed to be applied for balanced systems only in subparagraph (1) of this paragraph is to simulate the airspeed variations associated with stall tests, utilizing the airspeed system installed in the aircraft. For this purpose an additional airspeed instrument having a known calibration should be inserted in the airspeed

system adjacent to the pressure source, and a velocity-time history of instantaneous values for true and lagging total pressures be obtained by photo-recorder. It is necessary that a steady deceleration rate appropriate to that used during actual flight tests be maintained sufficiently long to allow the system lag to stabilize. The simulated velocity-time history should be appropriately corrected to the conditions existing in the actual stall flight tests.

(3) If the stalling speed tests are to be conducted with the propellers delivering zero thrust, some dependable method such as a propeller slipstream rake by means of which zero thrust condition can be ascertained should be available in flight. The general practice of establishing zero thrust r. p. m. by calculation is also acceptable. For the turbopropeller and turbojet powered aircraft of conventional design, the stall speed can be determined with flight idle power, in lieu of zero thrust, if it can be shown that this power does not materially affect the stall speed. If the stall speed is materially affected by the above power, corrections should be made to zero thrust conditions. Analytical corrections will be acceptable if satisfactory accounting is made for the effects of propeller efficiency, slipstream, altitude, and other pertinent variables. The stall speed should be determined below an altitude of 10,000 feet, where practicable, to minimize the altitude effect on flight idle power.

(4) An accurate method for determining the fuel load should be established for the purpose of ascertaining the airplane's gross weight and c. g. position at the time of each stall.

(5) Test instrumentation should consist of the usual sensitive indicators, especially sensitive tachometers, in order to be able to maintain r. p. m. which results in zero thrust. The time history during the stall should be recorded photographically, and should include those data indicated in paragraph (e) (4) of this section.

(b) The test methods required in the options that follow (see also fig. 1) are for the purpose of determining accurately the stalling speed used to calculate the pertinent performance climb requirements. The airplane loading during these tests will depend upon



the c. g.-weight range desired for approval, and whether the climb requirements are based on stalling speeds obtained with a fixed, or variable, c. g. position as indicated in subparagraphs (1) and (2) of this paragraph. In any case, the stalling speeds should be based on tests conducted for the most critical c. g.-weight combination, within the allowable tolerance specified in section 4b.100-1.

(1) *Climb requirement based on stalling speed at the most forward c. g. position desired for certification.*

(i) Under this option, the applicant should measure stalling speeds at the maximum forward c. g. position for certification and at the maximum landing weight. However, in some cases where the forward c. g. limit is variable with weight, this would require that stalling speed tests be conducted at a weight and c. g. position outside of the approved structural limit. In lieu of this, and if the applicant so desires, he may measure the stalling speeds at the maximum forward c. g. position for maximum landing weight and also at the maximum forward c. g. position desired for certification and its associated weight.

(ii) It is only necessary to conduct stall speed tests for one or two loading conditions, as indicated above, if the weight range from maximum takeoff to minimum landing weight, and the variations in c. g. positions are within the allowable tolerances specified in section 4b.100-1 (b) (2) with respect to both maximum takeoff and minimum landing weights. (See fig. 1, option 1, case A.) In cases where a large variation of weight exists, it may be necessary to make an additional check of the stalling speed at the most forward c. g. position corresponding to maximum takeoff weight. (See fig. 1, option 1, case B.)

(2) *Climb requirement based on stalling speed varying with c. g. position.* If this option is elected, the applicant should conduct a sufficient number of tests to adequately establish the variation of stalling speed with center of gravity position. In any case, the stalling speed should be measured at the maximum forward c. g. position desired for certification and at the most rearward c. g. position desired for the purpose of varying the climb requirement with c. g. position. In the event that the above

configurations do not encompass the maximum takeoff weight considering the allowable tolerances, stalling speed test should also be conducted at the maximum takeoff weight and its appropriate c. g.

(c) The deceleration rate actually utilized in each test may be obtained from the velocity-time history provided by photo-recorder data. For the purpose of determining the above deceleration rate,  $dV/dt$  should be based on the average slope of the velocity-time history, from a speed 10 percent above the minimum speed obtained with the test airspeed system, down to the minimum speed. (This method should not be used in calculating the appropriate lag corrections indicated in paragraph (a) (1) and (2) of this section.)

(d) *Configurations.* The stalling speed should be demonstrated in the configuration shown in subparagraphs (1) and (2) of this paragraph.

(1) *Configurations for demonstrating stalling speed  $V_{S0}$ , section 4b.112 (a).*

Weight—maximum landing or maximum weight at required c. g. position.

C. G. position—as required in paragraph (b) of this section.

Wing flaps—landing position.

Landing gear—extended.

Engines—idling or not more than sufficient power for zero thrust at a speed not greater than 110 percent of the stall speed.

Propeller controls—normal takeoff pitch.

Cowl flaps—closed.

Trim speed—as prescribed in section 4b.112 (c) (1).

(2) *Configuration for demonstrating stalling speeds  $V_{S1}$ , section 4b.112 (b).*

Weight—maximum landing or maximum weight at required c. g. position.

C. G. position—as required in paragraph (b) of this section.

Wing flaps—en route, takeoff and approach positions.

Landing gear—retracted.

Engines—idling or not more than sufficient power for zero thrust at a speed not greater than 110 percent of the stall speed.

Propeller controls—normal takeoff pitch.  
Cowl flaps—closed.

Trim speed—as prescribed in section 4b.112 (c) (1).

(e) *Test procedure and required data.*

(1) A sufficient number of representative stalls should be conducted for each airplane configuration and for each c. g. location as required in paragraphs (b) and (d) of this section in order to provide for accurate determination of the stall speeds at a  $dV/dt$  equals 1 mph/sec. The minimum number of stalls required will depend on the range of flap angles and other variable factors (such as variable c. g. position in determining the minimum climb requirement) which are proposed by the applicant. In cases where the flap positions have not been predetermined, it is permissible to conduct tests using four or more equally spaced flap angles. Based upon four equally spaced flap settings, an acceptable minimum number of representative stalls for each flap angle should be four. The minimum number of stalls at each flap angle should be increased if a lesser number of flap settings is proposed. For other configurations and variables a lesser number of stalls should be acceptable once a basic stall speed versus flap angle curve has been determined. Not more than zero propeller thrust should be used, as determined in paragraph (a) (3) of this section.

(2) The stalling speed tests should be conducted in accordance with the procedure outlined in section 4b.112 (c).

(3) Since the trim speed and the speed at which zero thrust r. p. m. is set (not more than 1.1  $V_{S1}$ ) are a function of the stall speed, a practice run should be made in order to determine the approximate stalling speed.

(4) The following data should be recorded photographically for each stall:

Vertical acceleration.	Air speed.
Angle of attack.	Altimeter.
Elevator angle.	R. P. M.

(5) In addition to the photorecorder record, the following data should be recorded for each stall:

Torque pressure.	Ambient air
C. G. position.	temperature.

R. P. M. for zero thrust at 1.1 $V_s$ .	Wing flap position.
Time.	Landing gear position.
Weight.	IAS at stall warning.
	Nature of stall warning.

(6) In subparagraph (4) of this paragraph, the following data may be omitted if the exception clause of section 4b.160 (c) (2) is applicable, or if during the demonstration of stall characteristics no marginal conditions existed and the elevator control was utilized to the full extent of its rearward (up elevator) travel. Under these circumstances the procedure used for stalling the aircraft to determine stall speeds, and recovery therefrom, should duplicate that used during the stall characteristics demonstration.

Elevator angle.  
Angle of attack.  
Vertical acceleration.

(22 F. R. 5791, July 20, 1957, effective Aug. 15, 1957; amended 24 F. R. 7067, Sept. 1, 1959, effective Oct. 1, 1959.)

#### 4b.113 *Takeoff; general.*

(a) **The takeoff data in sections 4b.114 to 4b.116, inclusive, shall be determined under the following conditions:**

- (1) **At all weights and altitudes selected by the applicant;**
- (2) **With a constant takeoff flap position for the particular weight and altitude;**
- (3) **With the operating engines not exceeding their approved limitations at the particular altitude.**

(b) **All takeoff data, when corrected, shall assume a level take-off surface, and shall be determined on a smooth, dry, hard-surfaced runway, in such a manner that reproduction of the performance does not require exceptional skill or alertness on the part of the pilot. (For temperature accountability data see sec. 4b.117. For wind and runway gradient corrections see appropriate operating rules of this subchapter.)**

4b.113-1 *Downwind takeoff (FAA policies which apply to sec. 4b.113).* Downwind takeoff data may be approved on the following basis to provide for situations where geographic locations and terrain indicate they are desirable:

(a) *Performance.* In determining the required distances for takeoff in downwind the data should be substantiated by actual flight tests. The general methods and procedures would be comparable to those for substantiating takeoff distances in no wind. The flight tests should be conducted in tailwind components up to 150 percent of the maximum velocity for which approval is desired except that the performance tests may be simulated in zero wind as outlined below:

(1) The accelerate portions of the "takeoff" and "accelerate-stop" should be demonstrated at speeds corresponding to the zero wind plus 150 percent of the tailwind component for which approval is desired. The calculated distances for entry in the Airplane Flight Manual should also be based on 1.5 times the tailwind component, see subparagraph (3) of this paragraph.

(2) The decelerate portion of the "accelerate-stop" should be demonstrated by stopping from a speed corresponding to  $V_1$  plus 1.5 times the tailwind velocity for which certification is desired.

(3) In determining the takeoff distances for the Airplane Flight Manual performance data, 150 percent of the effect of the reported tailwind component should be taken into account. (See sec. 4b.740-1 (d) (2) (x).) This may in some cases, permit calculating the required distances without further tests providing sufficiently high speed takeoffs and decelerations were made in the original type tests. However, except in the circumstances outlined in paragraph (d) of this section, actual takeoffs should be made under the conditions

outlined in paragraph (b) of this section to check the flight and ground handling characteristics.

(b) *Controllability.* Takeoffs should be made in steady downwind velocities equal to 1.5 times the maximum velocity for which approval is granted to check the controllability at the higher ground speeds with correspondingly reduced aerodynamic control forces, dynamic balance of landing gear, nose gear shimmy or vibration, etc.

(c) *Brakes.* At present it is believed that for calculated accelerate-stop distances based on actual airplane deceleration tests, the existing brake capacity requirements are sufficient to cover accelerate-stops in downwind velocities of 10 m. p. h. measured at 50' height. However, in wind velocities above 10 m. p. h. and in unusual cases or special types of operation additional tests or substantiation of the adequacy of the brakes may be necessary, and a revision to the braking system may be required.

(d) *Tolerances.*

(1) With regard to performance tests outlined in (a), approval may be given for calculated takeoff distances for reported tailwind velocities up to 10 m. p. h. measured at 50' height without camera tests additional to those required for approval of the no wind data.

(2) With regard to controllability tests outlined in (b), approval may be given for reported downwind velocities up to 10 m. p. h. measured at 50' height without additional flight tests.

(19 F. R. 1817, Apr. 2, 1954, effective Apr. 2, 1954; amended 20 F. R. 2277, Apr. 8, 1955, effective Apr. 30, 1955.)

### Discussion of Policies Relating to Determination of the Takeoff Field Length in Section 4b.113-2

The flight path specified in section 4b.113-2 (a) necessarily involves consideration of the level of skill of the pilot who happens to be flying the airplane at the time. The conditions under which this flight path is established provides for a reasonable level of skill by requiring certain minimum speeds which should be attained, as well as a sequence and timing in which it is assumed various configuration adjustments are made to the airplane, each of which have a measurable effect upon the resulting dimensions. The takeoff field length involves the determination of the distances traversed by the airplane for two alternative sequences of events. In the first case the airplane is accelerated

to the critical engine failure speed,  $V_1$  (see sec. 4b.114), at which speed all engines are made inoperative and the airplane decelerated to rest. In the second sequence of events the airplane is again accelerated to the same speed, but at that speed the critical engine only is made inoperative and the takeoff continued under certain specified conditions. The distance required to accelerate to the critical-engine-failure speed,  $V_1$ , is thus common to both sequences.

**4b.113-2 Determination of the takeoff field length (FAA policies which apply to sec. 4b.113).**

(a) The dimensions of a takeoff flight path should be such that, if the takeoff runway has a length equal to the greater of two possible dimensions of that flight path, an engine failure may occur at any point along the runway and the airplane be able either to stop within the length of the runway or to continue and clear all obstructions to flight until a safe landing is made.

(b) In the tests required by sections 4b.113 through 4b.116, generally one set of data at one altitude should be sufficient to determine takeoff distances for altitudes from sea level to 8,000 feet. If a greater range of airport altitudes is desired, the test should be conducted at two or more altitudes.

(19 F. R. 4451, July 20, 1954, effective Sept. 1, 1954.)

**4b.114 Takeoff speeds.**

(a) The critical-engine-failure speed  $V_1$ , in terms of calibrated airspeed, shall be selected by the applicant, but it shall not be less than the minimum speed at which the controllability is demonstrated during the takeoff run to be

adequate to permit proceeding safely with the takeoff, using normal piloting skill, when the critical engine is suddenly made inoperative.

(b) The minimum takeoff safety speed  $V_2$ , in terms of calibrated airspeed, shall be selected by the applicant so as to permit the rate of climb required in section 4b.120 (a) and (b), but it shall not be less than:

(1)  $1.2 V_{S1}$  for two-engine propeller-driven airplanes and for airplanes without propellers which have no provisions for obtaining a significant reduction in stalling speed with power on (one engine inoperative).

(2)  $1.15 V_{S1}$  for propeller-driven airplanes having more than two engines and for airplanes without propellers which have provisions for obtaining a significant reduction in stalling speed with power on (one engine inoperative).

(3) 1.10 times the minimum control speed  $V_{MC}$  established under section 4b.133.

(c) If engine failure is assumed to occur at or after the attainment of  $V_2$ , the demonstration in which the takeoff run is continued to include the takeoff climb, as provided in paragraph (a) of this section, shall not be required.

**Discussion of Policies Relating to Selection of the Takeoff Speeds in Section 4b.114-1**

Section 4b.114 (a) specifies a speed at which the engine is assumed to fail and which may be lower than the speed at which flight is possible. The operating requirements of section 40.72 of this chapter limit the takeoff operation of the airplane to a weight such that in the event of engine failure at the critical-engine-failure speed, ( $V_1$ ), the airplane can be brought to rest within the length of the runway or the takeoff continued and a height of 50 feet attained at the end of the runway. It follows that for any airplane at a particular weight there is an optimum value for this critical-engine-failure speed which results in the minimum required runway length and further, this optimum condition is obtained when the two alternative distances are equal. In the case of an airplane having a comparatively high wing loading but low power loading, and particularly in the case of airplanes with four or more engines, this optimum may be appreciably below the speed at which flight is possible.

The  $V_2$  speed specified in section 4b.114 (b) is a minimum speed at which it is considered safe to attempt to complete the takeoff with one engine inoperative. The limitation upon the takeoff safety speed, ( $V_2$ ), based upon stalling speed, involves the power-off stalling speed with 20 percent and 15 percent margins as reasonable minimums to insure against inadvertent stalling of the airplane.

For propeller-driven airplanes the difference between the two margins, based upon the number of engines installed in the airplane, is due to the fact that the application of power ordinarily reduces the stalling speed appreciably. In the case of the two-engine propeller-driven airplane, at least half of this reduction is eliminated by the failure of an engine. In the case of a four-engine propeller-driven airplane, certainly less than half and probably closer to one-quarter only of the difference is eliminated by the failure of an engine. The difference in the required factors, therefore, provides approximately the same margin over the actual stalling speed under the power conditions which are obtained after the loss of an engine no matter what the number of engines (in excess of one) may be. Unlike the propeller-driven airplane, the turbine engine airplane does not show any appreciable difference between the power-on and power-off stalling speeds. This is due to the absence of the propeller which ordinarily induces a slipstream with the application of power causing the wing to retain its lift to a speed lower than the power-off stalling speed. The applicant's selection of the two speeds specified will influence the nature of the testing required in establishing the takeoff flight path.

**4b.114-1 Selection of the takeoff speeds (FAA policies which apply to sec. 4b.114).**

(a) It should be possible to continue the takeoff acceleration after the failure of an engine at the speed,  $V_1$ , until a minimum safe flying speed has been attained. This condition should be demonstrated by test in order to determine that it can be safely accomplished. Throttling an opposite engine should not be permitted during the demonstration.

(b) It should not be necessary to demonstrate a takeoff that is continued after engine failure in the case where the applicant chooses to make the critical engine failure speed not less than the takeoff safety speed. If  $V_1$  is less than  $V_2$ , the tests should include an actual takeoff during which the critical engine is made inoperative at the minimum  $V_1$  speed and the takeoff continued after the speed  $V_2$  is attained.

(c) The minimum takeoff safety speed should be at least 10 percent in excess of the minimum speed at which the airplane can be safely controlled when the critical engine is suddenly made

inoperative under takeoff conditions in flight (See sec. 4b.133.)

(19 F. R. 4451, July 20, 1954, effective Sept. 1, 1954.)

**4b.115 Accelerate-stop distance.**

(a) **The accelerate-stop distance shall be the sum of the following:**

(1) **The distance required to accelerate the airplane from a standing start to the speed  $V_1$ ,**

(2) **Assuming the critical engine to fail at the speed  $V_1$ , the distance required to bring the airplane to a full stop from the point corresponding with the speed  $V_1$ .**

(b) **In addition to, or in lieu of, wheel brakes, the use of other braking means shall be acceptable in determining the accelerate-stop distance, provided that such braking means shall have been proven to be safe and reliable, that the manner of their employment is such that consistent results can be expected under normal conditions of operation, and that exceptional skill is not required to control the airplane.**

(c) **The landing gear shall remain extended throughout the accelerate-stop distance.**

### Discussion of Policies Relating to the Determination of the Accelerate-Stop Distance in Section 4b.115-1

In establishing an accelerate and stop distance it is obvious that when the throttles are suddenly closed, a finite time will elapse before the propellers and the rotating parts of the engine are decelerated from the takeoff r. p. m. to an idling r. p. m. During this period the propellers continue to exert thrust, until a certain zero thrust r. p. m. is reached as a result of the deceleration. For this reason the speed of the airplane continues to increase beyond that speed which exists at the moment the throttles are closed before it begins to decrease again. The period of time covered by the deceleration of the engine r. p. m. is also a very critical period for the application of brakes since there usually results a change in trim of the airplane which may necessarily require certain adjustments in the position of the controls.

4b.115-1 *Determination of the accelerate-stop distance (FAA policies which apply to sec. 4b.115).*

(a) *Establish representative dimensions.* In order to establish a representative dimension for the distance that would be required in the event of an actual failure of an engine during takeoff and the election of the pilot to stay on the ground, a sufficient number of runs should be conducted starting from rest and ending at rest to determine the transition distance for piecing together the acceleration and deceleration portion of the runs. In determining this distance, the wing flaps should be in the takeoff position at least until the engines have been made inoperative, but they may thereafter be altered to aid the deceleration if it is demonstrated by the applicant that this may be done with reasonable ease and safety. The accelerate-stop tests should be demonstrated in accordance with the following provisions: These tests are predicated on the assumption that the airplane is not equipped with reverse pitch or automatic feathering propellers.<sup>5</sup>

(1) Accelerate and stop runs should be conducted at two weights and at one altitude, and one deceleration run to demonstrate braking capacity and deceleration characteristics associated with the maximum altitude at which it is desired to certificate the airplane. Altitude conditions should be simulated by adjusting power and air speed. At least one representative run should be made for each of three engine failure speeds at each weight. If more than

one flap setting is to be used for takeoff, additional tests should be conducted to cover the flap range. (See sec. 4b.118-1 (d) (2).)

(2) If tests are not made at the maximum airport altitude, one landing or deceleration run should be made at an optional altitude for the purpose of demonstrating braking capacity and deceleration characteristics at maximum airport altitude and corresponding takeoff gross weight with the airplane at this maximum takeoff weight. The true ground speed at the start of the deceleration should correspond to that speed which would be experienced at the maximum airport altitude and weight. Discretion should be used in this test to assure remaining within safe structural and operational limits of the airplane.

(3) The accelerations may be made during takeoffs and the decelerations during landings at the takeoff configuration, providing a minimum of one acceleration and stop run is conducted at the maximum takeoff weight to determine the transition distance.

(4) Instrumentation should include means to record the airplane path relative to the runway against time in a manner to determine the horizontal distance-time history and a means should be provided to measure the wind velocity and direction, pressure altitude, engine r. p. m., manifold and/or torque pressure.

(i) The wind velocity should be measured adjacent to the runway at the height of 6 feet above the runway surface for test purposes. If wind effect on runway lengths is shown in the Airplane Flight Manual (see sec. 4b.740-1 (d) (2) (x)), the manual data should be based

<sup>5</sup> See section 4b.115-2 for policies covering automatic feathering propellers.

on reported wind velocities for a 50-foot tower height. Figure 2 should be used to calculate the wind velocity at the 50-foot height from the wind velocity measured at the 6-foot height.

(5) A special tolerance of not greater than  $\pm 2$  percent of the maximum takeoff weight is allowed for the accelerate-stop distance tests.

(b) *Configuration.* The accelerate-stop tests should be conducted in the configuration that follows:

Weight—maximum takeoff and one lower.  
C. G. position—most forward. (Most aft for reverse thrust decelerations.)

Wing flaps—takeoff position.

Landing gear—extended.

Operating engines—during acceleration, all engines operating at full takeoff power and r. p. m.; cowl flaps set in takeoff position (see sec. 4b.118-1 (d) (1)).

Inoperative engines—during deceleration, throttles closed; propellers windmilling in takeoff pitch (except for failed engine with automatic feathering, see sec. 4b.115-2); cowl flaps set in takeoff position (see sec. 4b.118-1 (d) (1)).

(c) *Test procedure and required data.*

(1) The airplane should be accelerated from full stop to each of three speeds up to  $V_1$ , the highest value of which should correspond to at least the maximum value desired for certification. The throttles should be closed at this speed and the airplane brought to a complete stop with the inoperative propellers windmilling (except when an auto-feathering device is installed).

(2) The airplane path relative to the runway should be recorded against time in a manner to determine the horizontal distance—time history.

(3) The following data should be recorded:

Pressure altitude.

Ambient air temperature.

Airplane gross weight.

R. P. M. (obtained during acceleration and deceleration).

Manifold pressure.

Torque pressure.

Carburetor air temperature.

Mixture setting.

Cowl flap position.

Wing flap position.

Time, distance, and airspeed at engine cut.

Slope of field.

Direction of run.

(4) In addition, humidity, wind direction, and wind velocity should be recorded adjacent to the runway at a height of 6 feet above the runway surface.

(19 F. R. 4451, July 20, 1954, effective Sept. 1, 1954.)

4b.115-2 *Approval of automatic propeller feathering installations for use in establishing accelerate-stop distance (FAA policies which apply to sec. 4b.115).* The accelerate-stop distance should be determined with the automatic propeller feathering installation feathering the propeller of the critical engine and with the other throttles closed at the instant of attainment of  $V_1$ . (See secs. 4b.10-2, 4b.401-1, 4b.700-1, and Civil Air Regulations Part 4b Interpretation No. 1, sec. 4b.133(a).)

(19 F. R. 1817, Apr. 2, 1954, effective Apr. 2, 1954.)

4b.115-3 *Reverse thrust used in accelerate-stop distance (FAA policies which apply to sec. 4b.115).* The policies outlined in section 4b.402-1 (k) will apply.

(20 F. R. 2277, Apr. 8, 1955, effective Apr. 30, 1955.)

4b.115-4 *Accelerate-stop distance with an antiskid device installed (FAA policies which apply to sec. 4b.115).* The policies outlined in section 4b.337-4 will apply.

(21 F. R. 2558, Apr. 19, 1956, effective May 15, 1956.)

4b.116 *Takeoff path.* The takeoff path shall be considered to consist of the following five consecutive elements:

(a) The distance required to accelerate the airplane to the speed  $V_2$ , assuming the critical engine to fail at the speed  $V_1$ .

(b) The horizontal distance traversed and the height attained by the airplane in the time required to retract the landing gear when operating at the speed  $V_2$  with:

(1) The critical engine inoperative, its propeller:

(i) Windmilling with the propeller control in a position normally used during takeoff until (if applicable) its rotation has been stopped (see paragraph (c) (1) of this section),

(ii) If applicable, stopped for the remainder of the gear retraction time.

(2) The landing gear extended.

(c) If applicable, the horizontal distance traversed and the height attained by the airplane in the time elapsed from the end of element (b) until the rotation of the inoperative propeller has been stopped when:

(1) The operation of stopping the propeller is initiated not earlier than the instant the airplane has attained a total height of 50 feet above the takeoff surface,

(2) The airplane speed is equal to  $V_2$ ,

(3) The landing gear is retracted,

(4) The inoperative propeller is wind-milling with the propeller control in a position normally used during takeoff.

(d) The horizontal distance traversed and the height attained by the airplane in the time elapsed from the end of element (c) until the time limit on the use of takeoff power is reached, while operating at the speed  $V_2$ , with:

(1) The inoperative propeller stopped,

(2) The landing gear retracted.

(e) The slope of the flight path followed by the airplane in the configuration of element (d), but drawing not more than maximum continuous power on the operating engine(s).

4b.116-1 *Approval of automatic propeller feathering installations for use in establishing the takeoff path (FAA policies which apply to sec. 4b.116).* The takeoff path may be modified by permitting a feathered propeller instead of wind-milling after the necessary time interval has elapsed from the instant of engine failure to complete feathering of the propeller. If it can be shown that the net work produced by the feathering propeller from the instant of engine failure to completion of feathering under all types of engine failure is positive using a datum based on feathered propeller drag, then it is permissible to assume that the propeller of the failed engine is in the feathered drag condition from the instant of attainment of the takeoff climb speed  $V_2$ . (See secs. 4b.10-2, 4b.401-1, and 4b.700-1.)

(19 F. R. 1818, Apr. 2, 1954, effective Apr. 2, 1954.)

### Discussion of Policies Relating to the Determination of the Takeoff Path in Section 4b.116-2

The takeoff path elements in section 4b.116 are intended to reflect, as closely as possible, the probable order in which a pilot would make changes to the airplane configuration in the actual case of an engine failure. They are conservative in their nature in an effort to simplify the testing required to establish the flight path. For example, it is assumed that the pilot will initiate gear retraction at the takeoff safety speed,  $V_2$ , immediately after the wheels leave the ground but that climbing performance does not increase during the retraction period over that with the gear fully extended. In the case of non-automatic propeller feathering systems it is assumed that the pilot would not initiate propeller feathering, if an engine fails during the ground run, prior to attaining a height of 50 feet, and further that the climb performance of the airplane remains the same as with the propeller wind-milling until the propeller feathering cycle is completed. However, in the case of an airplane with a slow retracting gear, propeller feathering may be started at the 50-foot height prior to the completion of the gear retraction as noted in section 4b.116 (c). It is also assumed that the cowl flaps on the inoperative engine will be closed when the airplane enters the third takeoff climb segment with the gear retracted and propeller feathered.



4b.116-2. *Determination of the takeoff path (FAA policies which apply to sec. 4b.116).*

(a) *Recommended procedure.* The recommended procedure for obtaining the takeoff path is to determine the ground and climb portions separately and piece the corrected data together. The takeoff flight path should be demonstrated in accordance with the following provisions:

(1) Three accelerations should be made during which the airplane is accelerated from a complete stop using all engines to speeds bracketing speed  $V_1$  at which speed the critical engine fuel mixture is cut and the acceleration continued to speed  $V_2$  with the inoperative engine propeller windmilling<sup>7</sup> in the takeoff pitch setting. If  $V_1$  is less than  $V_2$ , a takeoff should be made on one of the above runs when the critical engine is failed at the lowest  $V_1$  speed.

(2) The takeoff flap setting should be maintained throughout the takeoff flight path. If more than one flap setting is to be used for takeoff, additional tests should be included to cover the flap range (see sec. 4b.118-1(d)(2)).

(3) See section 4b.115-1 (a) (4) for instrumentation requirements.

(4) A special tolerance of not greater than  $\pm 2$  percent of the maximum takeoff weight is allowable for the ground portion of the accelerate distance.

(b) *General test program.*

(1) *Accelerate to takeoff safety speed,  $V_2$  section 4b.116 (a).*

(i) *Configuration.* These tests should be conducted in the configuration that follows:

Weight—maximum takeoff and one lower.

C. G. position—most forward.

Wing flaps—takeoff position.

Landing gear—extended.

Operating engine(s)—takeoff r. p. m. and manifold pressure, cowl flaps in takeoff position (see sec. 4b.118-1 (d) (1)).

Critical inoperative engine—fuel mixture cut on engine most critical

performancewise (see sec. 4b.118-1 (e) (2)), propeller windmilling in takeoff pitch (feathered if automatic feathering device is installed) and cowl flaps in takeoff position (see sec. 4b.118-1 (d) (1)).

(ii) *Test procedure and required data.*

The airplane should be accelerated from a complete stop to the  $V_1$  speed with all engines operating. The critical engine fuel mixture should be cut at the  $V_1$  speed and the acceleration should be continued until  $V_2$  speed is reached with the propeller of the inoperative engine windmilling in the takeoff pitch. The airplane's path relative to the runway should be recorded against time in a manner to determine the horizontal distance-time history. In addition the following data should be recorded:

Pressure altitude.

Ambient air temperature.

Airplane gross weight.

R. P. M.

Manifold pressure.

Torque pressure.

Mixture setting.

Cowl flap position.

Wing flap position.

Time, distance, and speed at engine cut.

Time, distance, and speed when  $V_2$  is reached.

Slope of field.

Direction of run.

In addition, humidity, wind direction, and wind velocity should be recorded adjacent to the runway at a height of 6 feet above the runway surface.

(2) *Initial takeoff flight path segment test, section 4b.116 (b).*

(i) *Configuration.* This test should be conducted in the configuration that follows:

Weight—maximum takeoff and one lower.

C. G. position—optional (see sec. 4b.118-1 (c) (2)).

Wing flaps—takeoff position.

Landing gear—extended.

Operating engine(s)—takeoff r. p. m. and manifold pressure or full throttle, mixture setting for takeoff, carburetor air heat control at cold

<sup>7</sup> When a satisfactory fully automatic propeller feathering device is installed on the airplane, advantage of such a device may be used in showing compliance with this section. See section 4b.115-1 for policies covering automatic propeller feathering systems.

and cowl flaps in takeoff position (see sec. 4b.118-1 (d) (1)).

Critical inoperative engine—throttle closed on engine most critical performance-wise (see sec. 4b.118-1 (e) (2)), propeller windmilling in takeoff pitch, (feathered if automatic feathering device is installed, see sec. 4b.120-1), mixture setting at idle cut-off and cowl flaps in takeoff position (see sec. 4b.118-1 (d) (1)).

(ii) *Test procedure and required data.*

The airplane should be climbed at the takeoff safety speed,  $V_2$ . See section 4b.118-1 for test procedure and required data in connection with climb tests.

(3) *Second takeoff flight path climb segment test, section 4b.116 (c).*

(i) *Configuration.* This test should be conducted in the configuration that follows:

Weight—maximum takeoff and one lower.

C. G. position—optional (see sec. 4b.118-1 (c) (2)).

Wing flaps—takeoff position.

Landing gear—retracted.

Operating engine(s)—takeoff r. p. m. and manifold pressure or full throttle, mixture setting for takeoff, carburetor air heat control at cold and cowl flaps in takeoff position (see sec. 4b.118-1 (d) (1)).

Critical inoperative engine—throttle closed on engine most critical performance-wise (see sec. 4b.118-1 (e) (2)), propeller windmilling in takeoff pitch, (feathered if automatic feathering device is installed, see sec. 4b.120-1), mixture setting at idle cut-off and cowl flaps in takeoff position (see sec. 4b.118-1 (d) (1)).

(ii) *Test procedure and required data.*

The airplane should be climbed at the takeoff safety speed,  $V_2$ . See section 4b.118-1 for test procedure and required data in connection with climb test.

(4) *Third takeoff flight path climb segment test, section 4b.116 (d).*

(i) *Configuration.* This test should be conducted in the configuration that follows:

Weight—maximum takeoff and one lower.

C. G. position—optional (see sec. 4b.118-1 (c) (2)).

Wing flaps—takeoff position.

Landing gear—retracted.

Operating engine(s)—takeoff r. p. m. and manifold pressure or full throttle, mixture setting for takeoff, carburetor air heat control at cold and cowl flaps in takeoff position (see sec. 4b.118-1 (d) (1)).

Critical inoperative engine—throttle closed on engine most critical performance-wise (see sec. 4b.118-1 (e) (2)), propeller feathered and cowl flaps in minimum drag position.

(ii) *Test procedure and required data.*

The airplane should be climbed at the takeoff safety speed,  $V_2$ . See section 4b.118-1 for test procedure and required data in connection with climb tests.

(5) *Fourth takeoff flight path climb segment test, section 4b.116 (e).*

(i) *Configuration.* This configuration should be the same as for the third takeoff flight path climb segment except that maximum continuous power is used on the operating engine(s).

(ii) *Test procedure and required data.*

The airplane should be climbed at the takeoff safety speed,  $V_2$ . See section 4b.118-1 for test procedure and required data in connection with climb tests.

(19 F. R. 4452, July 20, 1954, effective Sept. 1, 1954; amended 22 F. R. 6963, Aug. 29, 1957, effective Sept. 15, 1957.)

**4b.117 Temperature accountability.**

Operating correction factors for takeoff weight and take-off distance shall be determined to account for temperatures above and below standard, and when approved by the Administrator they shall be included in the Airplane Flight Manual. These factors shall be obtained as follows:

(a) For any specific airplane type, the average full temperature accountability shall be computed for the range of weights of the airplane, altitudes above sea level, and ambient temperatures required by the expected operat-

ing conditions. Account shall be taken of the temperature effect on both the aerodynamic characteristics of the airplane and on the engine power. The full temperature accountability shall be expressed per degree of temperature in terms of a weight correction, a take-off distance correction, and a change, if any, in the critical-engine-failure speed  $V_1$ .

(b) The operating correction factors for the airplane weight and takeoff distance shall be at least one-half of the full accountability

values. The value of  $V_1$  shall be further corrected by the average amount necessary to assure that the airplane can stop within the runway length at the ambient temperature, except that the corrected value of  $V_1$  shall not be less than a minimum at which the airplane can be controlled with the critical engine inoperative.

4b.118 *Climb; general.* Compliance shall be shown with the climb requirements of sections 4b.119 through 4b.121.

### Discussion of Policies Relating to Test Procedures for the Determination of Climb Performance in Section 4b.118-1

Sections 4b.119 through 4b.121 specify the airplane configurations which are considered to be representative for those operating conditions certain to be encountered in the use of the airplane. With the exception of section 4b.121, the requirements specify rates of climb which are believed to be the minimum that will guarantee the ability of the airplane to perform any necessary maneuver safely considering the possibility of an engine failure and other contingencies.

The required rates of climb specified in sections 4b.119 through 4b.120, where appropriate, are related to the stall speed squared since it has been assumed that the degree of danger associated with an emergency landing would be dependent upon the kinetic energy of the airplane. Equivalent safety dictates that excess power expressed in terms of rate of climb should be proportioned to the stall speed squared. For example, the one-engine-inoperative en route climb requirement defines a minimum rate of climb which is acceptable as evidence of the ability of the airplane to maintain altitude in case of an engine failure during cruising flight. The altitude, in standard atmospheric conditions, at which this rate of climb exists under the conditions specified becomes the basis of the operating rule specified in section 40.74 of this subchapter. Essentially similar reasoning has been used in determining climb criteria for the configurations in (a) through (c) of this section.

(a) *Climb: all engines operating, section 4b.119.*

(1) *Cruising configuration, section 4b.119 (a).* The factors which cause performance deterioration during cruising flight, such as inadequate cooling, high air temperatures, inefficient carburetion, etc., affect the airplane by reducing its available angle of climb. The climb requirement specified for this configuration will result in an approximate constant angle of climb regardless of the air speed and it is intended to insure that some climb performance will be available regardless of those conditions that may be encountered during the operation which impair performance.

(2) *Landing configuration, section 4b.119 (b).* This airplane configuration is ordinarily used in the final stages of an approach for landing, and the purpose of the specified required rate of climb is to assure that the descent may be readily arrested and that the airplane will be able to "go around" for another attempt at landing in the event conditions beyond the control of the pilot make this action necessary.

(b) *One-engine-inoperative climb, section 4b.120.*

(1) *Flaps in takeoff position: landing gear extended, section 4b.120 (a).*

This requirement is specified to insure that the airplane will have a positive

rate of climb during the initial stage of the takeoff for the configuration which is assumed to exist in this element.

(2) *Flaps in the takeoff position; landing gear retracted, section 4b.120 (b).* This airplane configuration is intended to be representative of the conditions which might be expected to occur in the event of an engine failure at about the time the airplane leaves the ground during takeoff. The rate of climb specified is believed to be a reasonable minimum which will insure the ability of the airplane to continue the takeoff under such circumstances. Because this segment is the more critical, it was not believed necessary to specify minimum climb requirements for the cleaner configuration which is assumed to be representative of the third or fourth takeoff flight path climb segments. However, the conduct of climb tests for the latter two configurations is necessary for the determination of the takeoff path required in section 4b.116.

(3) *Flaps in en route position, section 4b.120 (c).* See the second paragraph under "Discussion of policies relating to test procedures for the determination of climb performance in section 4b.118-1."

(4) *Flaps in approach position, section 4b.120 (d).* This airplane configuration is intended to represent conditions under which a pilot would attempt to "go around" after an approach in which the engine became inoperative and section 4b.120 (d) is intended to insure that the airplane will have the performance necessary to accomplish this maneuver.

(c) *Two-engine-inoperative climb, section 4b.121.* The probability of two engines failing in a single flight is considered remote and therefore it is not believed reasonable to specify a climb requirement which would have to be met for this configuration. Climb tests should be demonstrated in this configuration for the purpose of obtaining the data necessary to be shown in the Airplane Flight Manual.

4b.118-1 *Test procedures for the determination of climb performance (FAA policies which apply to sec. 4b.118).* The test conditions and methods in (a) through (i) of this section assume that the flight test data do not exhibit excessive scatter in points and that if such scatter makes the accuracy of the climb slopes questionable, additional tests and/or the applicants' previous flight test data for the particular configuration involved should be available. The following methods are also based upon consistent flight test data that can be properly correlated, and the use of previous acceptable test and correction methods. All new tests and correction methods will be judged upon their own merits. Polar curve or other equivalent methods are acceptable. The number of climb tests recommended for each case in (a) and (b) of this section represents a minimum, and in certain instances it is possible that more tests may be necessary.

(a) *For all takeoff path segments, landing and approach climb.*

(1) If it is desired to show that the required climb is met at the highest altitude and heaviest weight to be certified, a constant rate of climb curve with altitude should be acceptable. One good climb should be satisfactory if it is 50 ft./min., or more, in excess of the required climb at the highest altitude for which certification is desired. Three climbs (at same altitude) should be made if the R/C is less than 50 ft./min. in excess of the required climb. (No climb variation with weight or altitude.)

(2) If it is desired to determine the rate of climb vs. altitude curve:

(i) For a sea level engine, or the critical altitude above the maximum altitude of certification (no breaks in the curve) where the altitude range is not in excess of 8,000 feet, two good climbs at each weight over the altitude range if weight spread is in excess of 10 percent but not less than 4 climbs if only one weight is used. If the altitude range is in excess of 8,000 feet, three climbs at each weight over the altitude range (6 climbs if weight range is in excess of 10 percent) should be conducted.

(ii) For installations where a critical altitude is within the altitude range (one break in the curve) two climbs on one slope of the curve should be conducted at each weight and at least one climb on the other slope (6 climbs for a weight spread of 10 percent or more). If the altitude range is in excess of 8,000 feet, consideration should be given to the need for a fourth climb at each weight.

(iii) For installations where two breaks in the R/C curve occur within the certification range, four climbs at each weight should be made.

(b) *For all engine en route, one-engine-inoperative en route and two-engines-inoperative en route climbs.*

(1) The regulations specify that these climbs should be determined at all altitudes of expected use and weight of certification. For each weight at least the following climbs should be conducted:

Altitude Range	SL- 8,000	SL- 17,000	SL- 25,000
No breaks in curve (one slope)	1 2	1 3	4
One break (2 slopes)	1 3	4	4
Two breaks (3 slopes)		4	4-5
Three breaks (4 slopes)		5	5

<sup>1</sup> But not less than 4 if only one weight is used.

(2) When an airplane is approved for more than one landing flap position, the climb requirements for the cruising and en route configurations should be based upon the stall speed with the maximum sea level landing flap position for which the airplane is eligible.

(3) Where several climb points are available at the same test conditions the average point should be determined by averaging all consistent points not using the obviously erratic points (either high or low).

(c) *Weight and c. g. position.*

(1) The climb tests should be conducted at maximum takeoff weight for takeoff climbs and at maximum landing weight for landing climbs. Climbs should also be made at an optional lower weight for both the takeoff and landing configuration.

(2) Climbs may be made at any c. g. position except where the applicant elects to

vary the stalling speed with c. g. position in which case the most critical c. g. position should be used. (See sec. 4b.112-1 (b).)

(d) *Airplane configuration.*

(1) The cowl flaps should be set in the required position prior to conducting climb tests. The position of the cowl flaps for the takeoff segments should comply with the provisions of the takeoff cooling tests of section 4b.453.

(2) If more than one wing flap setting is to be used for takeoff or landing, additional tests should be included to cover the flap range (see sec. 4b.111-1 (b)).

(e) *Engine power.*

(1) The power should be stabilized prior to conducting the climb tests. The climbs should be made at constant power or at constant throttle setting. Unless limited by engine temperature, tests should be run for at least 3 minutes at takeoff power. If limited by temperature, short duration tests of approximately 1 minute duration should be acceptable provided the stabilized climbing speed is attained by accelerating from a lower speed. Where maximum continuous power is required, climb tests should be of 5 minutes duration or not necessarily more than climbs of 2,000 feet but in any case not less than 3 minutes. If climb tests are conducted for short durations, such as takeoff climbs which are limited by an engine rating of two minutes for takeoff power, consideration should be given to the necessity of conducting an adequate number of tests in order to obtain results which are representative of the actual performance.

(2) For the one-engine-inoperative climb tests, it may be assumed that the critical inoperative engine, performancewise, is the higher powered outboard engine unless there is evidence to indicate that another engine is more critical.

(3) For all climb tests, the powerplant equipment and accessories appropriate to the specific configuration being tested should be in operation. During each test, a record should be made of such accessories in operation and of the particular engine from which power is being absorbed.

(f) *Climb speeds.* The climb speeds are to be selected by the applicant, but should be

consistent with the performance and cooling requirements involved. The airspeed should be stabilized prior to conducting the climb tests.

(g) *Position of wings.* The airplane's wings should be maintained in a level attitude during all takeoff climb tests with one engine inoperative.

(h) *Climbs to be made in free air.* All climbs should be conducted in free air (without ground effect).

(i) *Data.* In addition to the following items, the data necessary to establish the weight and c. g. position during the climb tests should be recorded.

Pressure altitude recorded at 15 second intervals.

Humidity recorded at 15 second intervals.

Air speed recorded at 15 second intervals.

R. P. M.

Manifold pressure.

Torque pressure.

Carburetor air temperature.

Mixture setting.

Throttle setting.

Cowl flap position.

Wing flap position.

Landing gear position.

(19 F. R. 4452, July 20, 1954, effective Sept. 1, 1954.)

#### 4b.119 *Climb; all engines operating.*

(a) *Cruising configuration.* In the cruising configuration the steady rate of climb in feet per minute at 5,000 feet shall not be less than  $8 V_{so}$ . In addition the steady rate of climb shall be determined at any altitude at which the airplane is expected to operate and at any weight within the range of weights to be specified in the airworthiness certificate. The cruising configuration shall be with:

(1) Landing gear fully retracted,

(2) Wing flaps in the most favorable position,

(3) Cowl flaps (or other means of controlling the engine cooling) in the position which provides adequate cooling in the hot-day condition,

(4) Center of gravity in the most unfavorable position,

(5) All engines operating within the maximum continuous power limitations,

(6) Maximum takeoff weight.

(b) *Landing configuration.* In the landing configuration the steady rate of climb in feet per minute shall not be less than  $0.07 V_{so}^2$  at any altitude within the range for which landing weight is to be specified in the certificate, with:

(1) Landing gear extended,

(2) Wing flaps in the landing position (see secs. 4b.111 and 4b.323),

(3) Cowl flaps in the position normally used in an approach to a landing,

(4) Center of gravity in the most unfavorable position permitted for landing,

(5) All engines operating at the takeoff power available at such altitude,

(6) The weight equal to maximum landing weight for that altitude,

(7) A climb speed not in excess of  $1.4 V_{so}$ .  
4b.119-1 *Determination of all engine climb (FAA policies which apply to sec. 4b.119).*

(a) *Cruising configuration test, section 4b.119 (a).*

(1) *Configuration.* This test should be conducted in the configuration that follows:

Weight—maximum takeoff and one lower.

C. G. position—optional (see sec. 4b.118-1 (c) (2)).

Wing flaps—optional.

Landing gear—retracted.

Engines—maximum continuous r. p. m. and manifold pressure or full throttle, mixture setting in normal position, carburetor air heat control cold and cowl flaps in FAA hot day cooling position.

(2) *Test procedure and required data.* See section 4b.118-1 for test procedure and required data in connection with climb tests.

(b) *Landing configuration test, section 4b.119 (b).*

(1) *Configuration.* This test should be conducted in the configuration that follows:

Weight—maximum landing and one lower.

C. G. position—optional (see sec. 4b.118-1 (c) (2)).

Wing flaps—landing position.

Landing gear—extended.

Engines—takeoff power and manifold pressure or full throttle mixture setting

in normal position, carburetor air heat control cold and cowl flaps in approach position.

(2) *Test procedures and required data.* See section 4b.118-1 for test procedure and required data in connection with climb tests.

(19 F. R. 4453, July 20, 1954, effective Sept. 1, 1954.)

#### 4b.120 *One-engine-inoperative climb.*

(a) *Flaps in takeoff position; landing gear extended.* The steady rate of climb without ground effect shall not be less than 50 ft./min. at any altitude within the range for which takeoff weight is to be specified in the certificate, with:

(1) Wing flaps in the takeoff position (see secs. 4b.111 and 4b.323),

(2) Cowl flaps in the position normally used during takeoff,

(3) Center of gravity in the most unfavorable position permitted for takeoff,

(4) The critical engine inoperative, its propeller windmilling with the propeller control in a position normally used during takeoff,

(5) All other engines operating at the takeoff power available at such altitude,

(6) The speed equal to the minimum takeoff safety speed  $V_2$  (see sec. 4b.114 (b)),

(7) The weight equal to maximum takeoff weight for that altitude,

(8) Landing gear extended.

(b) *Flaps in takeoff position; landing gear retracted.* With the landing gear retracted the steady rate of climb in feet per minute shall not be less than  $0.035 V_{s1}^2$  with all other conditions as described in paragraph (a) of this section.

(c) *Flaps in en route position.* The steady rate of climb in feet per minute at any altitude at which the airplane is expected to operate, at any weight within the range of weights to be specified in the airworthiness certificate, shall be determined and shall, at a standard altitude of 5,000 feet and at the maximum takeoff weight, be at least

$$\left(0.06 - \frac{0.08}{N}\right) V_{s0}^2,$$

where  $N$  is the number of engines installed, with:

(1) The landing gear retracted,

(2) Wing flaps in the most favorable position,

(3) Cowl flaps or other means of controlling the engine cooling air supply in the position which provides adequate cooling in the hot-day condition,

(4) Center of gravity in the most unfavorable position,

(5) The critical engine inoperative, its propeller stopped,

(6) All remaining engines operating at the maximum continuous power available at the altitude.

(d) *Flaps in approach position.* The steady rate of climb in feet per minute shall not be less than  $0.04 V_{s0}^2$  at any altitude within the range for which landing weight is to be specified in the certificate, with:

(1) The landing gear retracted,

(2) Wing flaps set in position such that  $V_{s1}$  does not exceed  $1.10 V_{s0}$ ,

(3) Cowl flaps in the position normally used during an approach to a landing,

(4) Center of gravity in the most unfavorable position permitted for landing,

(5) The critical engine inoperative, its propeller stopped,

(6) All remaining engines operating at the takeoff power available at such altitude,

(7) The weight equal to the maximum landing weight for that altitude,

(8) A climb speed not in excess of  $1.5 V_{s1}$ .

4b.120-1 *Approval of automatic propeller feathering installations for use in establishing flaps in takeoff position climb (FAA policies which apply to sec. 4b.120 (a) and (b)).* The propeller of the inoperative engine may be in the feathered condition during either or both of the landing gear extended or retracted conditions if:

(a) The propeller would be completely feathered at the beginning of these segments of the takeoff flight path, or

(b) It can be shown that the network produced by the feathering propeller during the segment is positive using a datum based on feathered propeller drag. (See secs. 4b.10-2, 4b.401-1, and 4b.700-1.)

(19 F. R. 1818, Apr. 2, 1954, effective Apr. 2, 1954.)

4b.120-2 *Determination of one-engine-inoperative climb (FAA policies which apply to sec. 4b.120).*

(a) *Flaps in takeoff position; landing gear extended, section 4b.120 (a).* Policies outlined in section 4b.116-2 (b) (2) will apply.

(b) *Flaps in takeoff position; landing gear retracted, section 4b.120 (b).* Policies outlined in section 4b.116-2 (b) (3) will apply.

(c) *Flaps in en route position, section 4b.120 (c).*

(1) *Configuration.* This test should be conducted in the configuration that follows:

Weight—maximum takeoff and one lower.

C. G. position—optional (see sec. 4b.118-1 (c) (2)).

Wing flaps—optional.

Landing gear—retracted.

Operating engine(s)—maximum continuous r. p. m. and manifold pressure or full throttle, mixture setting at normal position, carburetor air heat control at cold and cowl flaps in FAA hot day cooling position.

Critical inoperative engine — throttle closed on engine most critical performance-wise (see sec. 4b.118-1 (e) (2)), propeller feathered and cowl flaps in minimum drag position.

(2) *Test procedure and required data.* The airplane should be climbed at the en route climb speed. See section 4b.118-1 for test procedure and required data in connection with climb tests.

(d) *Flaps in approach position, section 4b.120 (d).*

(1) *Configuration.* This test should be conducted in the configuration that follows:

Weight—maximum landing and one lower.

C. G. position—optional (see sec. 4b.118-1 (c) (2)).

Wing flaps—approach position ( $V_s$ , must not exceed  $1.10 V_{s0}$ ).

Landing gear—retracted.

Operating engine(s)—takeoff r. p. m. and manifold pressure or full throttle, mixture setting at normal position, carburetor air heat control at cold and cowl flaps in approach position.

Critical inoperative engine — throttle closed on engine most critical performance-wise (see sec. 4b.118-1 (e) (2)), propeller feathered and cowl flaps position optional.

(2) *Test procedure and required data.* The airplane should be climbed at the approach climb speed. See section 4b.118-1 for test procedure and required data in connection with climb tests.

(19 F. R. 4453, July 20, 1954, effective Sept. 1, 1954.)

**4b.121 *Two-engine-inoperative climb.*** For airplanes with four or more engines, the steady rate of climb at any altitude at which the airplane is expected to operate, and at any weight within the range of weights to be specified in the Airplane Flight Manual, shall be determined with:

(a) The landing gear retracted,

(b) Wing flaps in the most favorable position,

(c) Cowl flaps or other means of controlling the engine cooling air supply in the position which will provide adequate cooling in the hot-day condition,

(d) Center of gravity in the most unfavorable position,

(e) The two critical engines on one side of the airplane inoperative and their propellers stopped,

(f) All remaining engines operating at the maximum continuous power available at that altitude.

4b.121-1 *Determination of two-engine-inoperative climb (FAA policies which apply to sec. 4b.121).*

(a) *Configuration.* This test should be conducted in the configuration that follows:

Weight—two optional weights.

C. G. position—optional (see sec. 4b.118-1 (c) (2)).

Wing flaps—optional.

Landing gear—retracted.

Operating engines—maximum continuous r. p. m. and manifold pressure or full throttle, mixture setting at normal position, carburetor air heat control at cold and cowl flaps in FAA hot day cooling position.

Critical inoperative engines—throttles closed on outboard engine most critical



performancewise (see sec. 4b.118-1 (e) (2)), and on adjacent engine, propellers feathered and cowl flaps in minimum drag position.

(b) *Test procedure and required data.* See section 4b.118-1 for test procedure and required data in connection with climb tests.

(19 F. R. 4454, July 20, 1954, effective Sept. 1, 1954.)

**4b.122 Determination of the landing distance; general.** The horizontal distance required to land and to come to a complete stop (to a speed of approximately 3 m. p. h. for seaplanes or float planes) from a point at a height of 50 feet above the landing surface shall be determined for a range of weights and altitudes selected by the applicant. In making this determination the following conditions shall apply:

(a) A steady gliding approach shall have been maintained down to the 50-foot altitude with a calibrated air speed of not less than  $1.3 V_{so}$ .

(b) The nose of the airplane shall not be depressed, nor the forward thrust increased by application of power after reaching the 50-foot altitude.

(c) At all times during and immediately prior to the landing, the flaps shall be in the landing position, except that after the airplane is on the landing surface and the calibrated air speed has been reduced to not more than  $0.9 V_{so}$ , the flap position may be changed.

(d) The landing shall be made in such manner that there is no excessive vertical acceleration, no tendency to bounce, nose over, ground loop, porpoise, or water loop, and in such manner that its reproduction shall not require any exceptional degree of skill on the part of the pilot, or exceptionally favorable conditions.

4b.122-1 *Downwind landings (FAA policies which apply to sec. 4b.122).* Downwind landing data will be approved on the following basis to provide for situations where geographic locations and terrain indicate they are desirable, as well as for use with ILS:

(a) *Performance.* In determining the required distances for landing downwind, the data should be substantiated by actual flight tests. The general methods and procedures should be comparable to those for substantiating landing distances in no wind. The flight tests should be conducted in tailwind velocities

up to the maximum velocity for which approval is desired except that the performance tests may be simulated in zero wind as outlined below:

(1) Landings should be demonstrated by approaching and contacting at speeds corresponding to the zero wind speed plus 150 percent of the tailwind velocity for which approval is desired.

(2) In determining the downwind landing distances for the Airplane Flight Manual data, 150 percent of the effect of the reported tailwind velocity should be taken into account. (See sec. 4b.740-1 (d) (2) (x).) This may in some cases, permit calculating the required distances without further tests providing sufficiently high speed landings and decelerations were made in the original type tests. However, except in the cases outlined in paragraph (d) of this section, actual landings should be made under the conditions described in paragraph (b) of this section, to check the flight and ground handling characteristics.

(b) *Controllability.* Landings should be made in steady downwind velocities equal to 1.5 times the maximum velocity for which approval is desired to check the controllability at the higher ground speed with correspondingly reduced aerodynamic control forces, dynamic balance of landing gear, nose gear shimmy or vibration, etc. Also actual approaches should be demonstrated under the above wind conditions at an approach angle corresponding to the maximum ILS beam angle ( $3^{\circ} 18'$ ) to determine the minimum altitude on the glide path from which the airplane can be readily flared for landing.

(c) *Brakes.* At present it is believed that for calculated landing distance based on actual airplane deceleration tests, the existing brake capacity requirements are sufficient to cover landings in downwind velocities of 10 m. p. h. measured at  $50'$ . However, in wind velocities above 10 m. p. h. and in unusual cases or special types of operation, additional tests or substantiation of the adequacy of the brakes may be necessary and a revision to the braking system may be required. In determining the landing distances under paragraph (a) of this section, normal braking as outlined in section 4b.123 "Landplanes" should not be exceeded.

(d) *Tolerances.*

(1) With regard to performance tests outlined in paragraph (a) of this section, approval will be given for calculated landing distances for reported tailwind velocities up to 10 m.p.h. measured at 50 feet height without camera tests additional to those required for approval of the no wind data.

(2) With regard to controllability tests outlined in paragraph (b) of this section, approval will be given for reported downwind velocities up to 10 m.p.h. measured at 50 feet without additional flight tests.

(19 F.R. 1818, Apr. 2, 1954, effective Apr. 2, 1954; amended 20 F.R. 2277, Apr. 8, 1955, effective Apr. 30, 1955.)

### Discussion of Policies Relating to Determination of the Landing Distances in Section 4b.122-2

The purpose of the requirement specified in section 4b.122 is to determine a distance from a point 50 feet above the takeoff surface to land and bring the airplane to rest. This procedure is representative of the actual operating technique and may serve as the basis for the specification of a landing runway length within which a pilot of average skill may reasonably be expected to be able to land the airplane safely under the most adverse weather or other operating conditions likely to be encountered in the actual operation.

The minimum approach speed of  $1.3 V_s$ , specified in section 4b.122 (a) is intended to provide a reasonable margin above the stalling speed. The "steady gliding approach" is an approach at essentially constant indicated air speed for a sufficient length of time prior to reaching the 50-foot point to simulate a continuous approach at this speed.

Sections 4b.122 (b), (c), and (d) are concerned primarily with preventing airplane contact with the runway surface at a very high speed in order to take advantage of the greater deceleration provided by most wheel brake installations than is available from the drag of the airplane while still airborne. Flight Engineering Report No. 1, "Investigation of the Landing Distance Required by CAR 04.7503 for a Typical Airplane," covers an investigation undertaken to determine the effect of various factors which were considered in drafting section 4b.122 and indicates the critical dependence of the landing distance here defined upon the contact speed. The purposes of section 4b.122 (d) would be defeated if a distance is obtained by making contact at high speed which would require an exceptional degree of skill on the part of the pilot, or to base, a distance upon exceptionally favorable conditions such as wind or the nature of the surface of the runway.

#### 4b.122-2 *Determination of the landing distances (FAA policies which apply to sec. 4b.122).*

(a) When a particular airplane cannot comply with that part of section 4b.122 (d) regarding exceptional degree of skill on the part of the pilot in landing from the 50-foot height with power off, compliance with the regulation should be shown by applying sufficient power during the approach to permit satisfactory landing.

(b) In the tests required by sections 4b.123 through 4b.124 generally one set of data at one altitude should be sufficient to determine the

landing distances for altitudes from sea level to 8,000 feet. If a greater range of airport altitudes is desired, the tests should be conducted at two or more altitudes.

(19 F. R. 4454, July 20, 1954, effective Sept. 1, 1954.)

4b.122-3 *Reverse thrust used in determination of landing distance (FAA policies which apply to sec. 4b.122).* The policies outlined in section 4b.402-1 (1) will apply.

(20 F. R. 2277, Apr. 8, 1955, effective Apr. 30, 1955.)

4b.122-4 *Determination of the landing distance with an antiskid device installed (FAA*

policies which apply to sec. 4b.122). The policies outlined in section 4b.337-4 will apply.

(21 F. R. 2258, Apr. 19, 1956, effective May 15, 1956.)

**4b.123 Landplanes.** The landing distance referred to in section 4b.122 shall be determined on a dry, hard-surfaced runway in accordance with the following:

(a) The operating pressures on the braking system shall not be in excess of those approved by the manufacturer of the brakes,

(b) The brakes shall not be used in such manner as to produce excessive wear of brakes or tires,

(c) Means other than wheel brakes may be used in determining the landing distance: **Provided, That:**

(1) Exceptional skill is not required to control the airplane,

(2) The manner of their employment is such that consistent results could be expected under normal service, and

(3) They are regarded as reliable.

4b.123-1 *Excessive wear of brakes or tires (FAA interpretation which applies to sec. 4b.123 (b)).* "Excessive wear" is interpreted as skidding of a tire or excessive heating of the brakes which requires replacement during a series of five official test landings.

(19 F. R. 4454, July 20, 1954, effective Sept. 1, 1954.)

4b.123-2 *Determination of the landing distance (landplanes) (FAA policies which apply to sec. 4b.123).*

(a) *Landing tests.* The landing test should be demonstrated in accordance with the following provisions:

(1) Landings should be made over an imaginary 50-foot obstacle at the maximum landing weight and at a lower weight at one altitude.

(2) During the landing demonstrations, the glide path should be established by the pilot as set forth in section 4b.122. The forward thrust should not be increased beyond the 50-foot obstacle. The ground roll should lie as close to a rectilinear path as possible including the airplane stop point. During each demonstration landing, the airplane should be brought to a complete stop.

(3) *Instrumentation:*

(i) Instrumentation should include a means to record the airplane's glide path rela-

tive to the ground and the ground roll against time in a manner to determine the horizontal and vertical distance-time histories.

(ii) A means should be provided to measure the wind velocity and direction, pressure altitude, and ambient air temperature. The wind measurement should be made at the height of 6 feet above the runway surface. If wind effect on runway lengths is shown in the Airplane Flight Manual (see sec. 4b.740-1 (d) (2) (x)), the manual data should be based on reported wind velocities for a 50-foot tower height. Figure 2 should be used to calculate the wind velocity at the 50-foot height from the wind velocity measured at 6 feet above the runway surface.

(iii) The ground roll distance from contact to full stop should be established by observers if it is difficult to establish the exact contact point by graphical means.

(4) A special tolerance of not greater than  $\pm 2$  percent of the maximum landing weight is allowable for the landing distance tests.

(b) *Configuration.* The landing tests should be demonstrated in the configuration that follows:

Weight—maximum landing and one lower.  
C. G. position—most forward for braked landings.

Wing flaps—landing position.

Landing gear—extended.

(c) *Test procedure and required data.*

(1) Three landings should be conducted at each weight with the airplane stabilized in a glide at a calibrated air speed of not less than  $1.3 V_{so}$  approximately 1,000 feet (longitudinally) prior to reaching an altitude of 50 feet. Forward thrust should not be increased beyond the 50-foot obstacle; braking should not exceed manufacturer's approved maximum brake pressure and should be applied in such a manner as not to produce excessive wear of brakes and tires as evidenced by five measured landings. If more than one flap setting is to be used for landing, additional tests should be conducted to cover the flap range. (See sec. 4b.118-1 (d) (2).)

(2) The airplane path relative to the runway should be recorded against time in a manner to determine the horizontal and vertical

distance-time history. In addition, the following data should be recorded:

- Pressure altitude.
- Ambient air temperature.
- Airplane gross weight.
- R. P. M.
- Manifold pressure.
- Torque pressure.
- Carburetor air temperature.
- Mixture setting.
- Cowl flap position.
- Wing flap position.
- Slope of field.
- Direction of landing run.

(3) Wind direction and wind velocity should be recorded adjacent to the runway at a height of 6 feet.

(19 F. R. 4454, July 20, 1954, effective Sept. 1, 1954; amended 22 F. R. 6963, Aug. 29, 1957, effective Sept. 15, 1957.)

**4b.123-3** *Reverse thrust used in landing distance—landplanes (FAA policies which apply to sec. 4b.123 (c)).* The policies outlined in section 4b.402-1 (1) will apply.

(20 F. R. 2277, Apr. 8, 1955, effective Apr. 30, 1955.)

**4b.123-4** *Procedure in determination of landing distance with an antiskid device installed (FAA policies which apply to sec. 4b.123).* The policies outlined in section 4b.337-4 will apply.

(21 F. R. 2558, Apr. 19, 1956, effective May 15, 1956.)

**4b.124** *Seaplanes or floatplanes.* The landing distance referred to in section 4b.122 shall be determined on smooth water.

**4b.124-1** *Determination of the landing distance (seaplanes) (FAA policies which apply to sec. 4b.124).* Policies outlined in sections 4b.122-2 and 4b.123-2 will apply.

(19 F. R. 4454, July 20, 1954, effective Sept. 1, 1954.)

**4b.125** *Skiplanes.* The landing distance referred to in section 4b.122 shall be determined on smooth, dry snow.

**4b.125-1** *Determination of the landing distances (skiplanes) (FAA policies which apply to sec. 4b.125).* Policies outlined in sections 4b.122-2 and 4b.123-2 will apply.

(19 F. R. 4454, July 20, 1954, effective Sept. 1, 1954.)

## Controllability

### 4b.130 *Controllability; general.*

(a) The airplane shall be safely controllable and maneuverable during takeoff, climb, level flight, descent, and landing.

(b) It shall be possible to make a smooth transition from one flight condition to another, including turns and slips, without requiring an exceptional degree of skill, alertness, or strength on the part of the pilot and without danger of exceeding the limit load factor under all conditions of operation probable for the type, including those conditions normally encountered in the event of sudden failure of any engine.

[(c) Compliance with the "strength of pilots" limits in paragraph (b) of this section need not be demonstrated unless the condition is found to be marginal. In the latter case, they shall not exceed the following pilot control force limits, expressed in pounds:

	Pitch	Roll	Yaw
(1) For temporary application---	75	60	180
(2) For prolonged application---	10	5	20

Pitch and roll forces shall be measured as applied to the control wheel.

[(d) For the purpose of complying with the temporary control force limitations of paragraph (c) of this section, the airplane shall be operated in accordance with approved operating procedure or conventional operating practice including being as nearly trimmed as possible at the prior steady flight condition, except that in the case of takeoff the airplane shall be trimmed in accordance with approved operating procedures.

[(e) For the purpose of complying with the prolonged control force limitations of paragraph (c) of this section, the airplane shall be as nearly trimmed as possible.]

[(Amendment 4b-12, published 27 F. R. 2986, Mar. 30, 1962, effective May 3, 1962.)]

**4b.130-1** *Procedure for demonstrating controllability qualities (FAA policies which apply to sec. 4b.130).* The general controllability and maneuverability qualities of the airplane should be observed and noted throughout the flight test program. The amount of force required to be exerted on the controls in conducting such

maneuvers specified in section 4b.130 should also be noted.

(19 F. R. 4454, July 20, 1954, effective Sept. 1, 1954.)

#### 4b.131 *Longitudinal control.*

(a) It shall be possible at all speeds between the trim speed prescribed in section 4b.112(c) (1) and  $V_{S1}$  to pitch the nose downward so that a prompt recovery to this selected trim speed can be made with the following combination of airplane configurations:

(1) The airplane trimmed at the trim speed prescribed in section 4b.112(c)(1),

(2) The landing gear extended,

(3) The wing flaps in a retracted, and in an extended position,

(4) Power off, and maximum continuous power on all engines.

(b) [During each of the following controllability demonstrations, a change in the trim control shall not be required. In addition, exertion of more than 50 pounds control force, representative of the maximum temporary force which can readily be applied by one hand, shall not be required.] Each maneuver shall be performed with the landing gear extended.

(1) With power off, flaps retracted and the airplane trimmed at  $1.4 V_{S1}$ , the flaps shall be extended as rapidly as possible while maintaining the airspeed approximately 40 percent above the stalling speed prevailing at any instant throughout the maneuver.

(2) The maneuver of subparagraph (1) of this paragraph shall be repeated, except that it shall be started with flaps extended and the airplane trimmed at  $1.4 V_{S1}$ , after which the flaps shall be retracted as rapidly as possible.

(3) The maneuver of subparagraph (2) of this paragraph shall be repeated, except that take-off power shall be used.

(4) With power off, flaps retracted, and the airplane trimmed at  $1.4 V_{S1}$ , take-off power shall be applied quickly while maintaining the same airspeed.

(5) The maneuver of subparagraph (4) of this paragraph shall be repeated, except that the flaps shall be extended.

(6) With power off, flaps extended, and the airplane trimmed at  $1.4 V_{S1}$ , airspeeds within the range of  $1.1 V_{S1}$  to  $1.7 V_{S1}$  or to  $V_{FE}$ , whichever of the two is the lesser, shall be obtained and maintained.

(c) It shall be possible without the use of exceptional piloting skill to prevent loss of altitude when wing flap retraction from any position is initiated during steady straight level flight at a speed equal to  $1.1 V_{S1}$  with simultaneous application of not more than maximum continuous power, with the landing gear extended, and with the airplane weight equal to the maximum sea level landing weight. (See also sec. 4b.323.)

[(Amendment 4b-12, published 27 F. R. 2986, Mar. 30, 1962, effective May 3, 1962.)]

### Discussion of Policies Relating to Procedure for Demonstrating Longitudinal Control in Section 4b.131-1

Section 4b.131 (b) requires changes to be made in flap position and/or power which are likely to be encountered during an approach when it becomes necessary to go around for another attempt at landing. Its purpose is to insure that any of these changes are possible assuming that the pilot finds it necessary to devote at least one hand to the initiation of the desired operation without being overpowered by the primary airplane controls. It aims at a design such that no excessive change in trim results from the application or removal of power or the extension or retraction of wing flaps. Compliance with its terms also requires that the relation of control force to speed be such that reasonable changes in speed may be made without encountering very high control forces.

Section 4b.131 (c) is concerned with the eventuality of going around during an approach for landing in which event it is obviously desirable to be able to retract the wing flaps quickly and automatically at such a rate that there will be no loss of altitude if power is applied simultaneously with the initiation of flap retraction. The design feature involved in this requirement is the rate of flap retraction.

4b.131-1 *Procedure for demonstrating longitudinal control (FAA policies which apply to sec. 4b.131).* The flight tests specified in (a) through (h) of this section should be made in demonstrating compliance with section 4b.131. These tests may be conducted at an optional altitude (see sec. 4b.100-3 (c)). Where applicable, the following conditions should be maintained on the engines: propellers in low pitch, throttles—closed except as noted; cowl flaps—appropriate for the flight condition.

(a) *Longitudinal control recovery, section 4b.131 (a).* The test specified by this requirement should be demonstrated with power off and also with maximum continuous power.

(1) *Configuration.* This test should be conducted in the configuration that follows:

(i) Maximum takeoff weight, flaps and landing gear retracted, c. g. position—most aft.

(ii) Maximum landing weight, flaps extended in the maximum landing position; landing gear extended, c. g. position—most aft.

(The flap extended portion of this test may be combined with tests under paragraph (g) of this section.)

(2) *Test procedure and required data.* The airplane should be trimmed at the speed prescribed in section 4b.112(c)(1); the nose should be pitched downward starting from any speed between that prescribed in section 4b.112(c)(1) and  $V_{S1}$ . The rate of increase in airspeed should be satisfactory for prompt acceleration to the trim speed prescribed in section 4b.112(c)(1). The following data should be recorded:

Weight.  
C. G. position.  
Wing flap position.  
Landing gear position.  
Engines, r. p. m. and manifold pressure.  
Pressure altitude.  
Ambient air temperature.  
Trim speed.  
Lowest speed from which pitch is satisfactory.  
Altitude lost to regain trim speed.

(b) *Longitudinal control, flap extension, section 4b.131 (b) (1).*

(1) *Configuration.* This test should be conducted in the configuration that follows:

Weight—maximum landing.

C. G. position—most forward and most aft.

Wing flaps—retracted.

Landing gear—extended.

Engines—power off.

(2) *Test procedure and required data.* The airplane should be trimmed at a speed of  $1.4 V_{S1}$ ; the flaps should be extended to the maximum landing position as rapidly as possible. During this maneuver, it should be possible to control the airplane with one hand for a reasonable time without the necessity of changing the trim control. The following data should be recorded:

Weight.

C. G. position.

Wing flap position.

Landing gear position.

Engines, r. p. m. and manifold pressure.

Pressure altitude.

Ambient air temperature.

Trim speed at  $1.4 V_{S1}$ .

(c) *Longitudinal control, flap retraction, section 4b.131 (b) (2).*

(1) *Configuration.* This test should be conducted in the configuration that follows:

Weight—maximum landing.

C. G. position—most forward and most aft.

Wing flaps—maximum landing position.

Landing gear—extended.

Engines—power off.

(2) *Test procedures and required data.* The airplane should be trimmed at a speed of  $1.4 V_{S1}$ ; the flaps should be retracted as rapidly as possible. During this maneuver, it should be possible to control the airplane with one hand for a reasonable time without the necessity of changing the trim control. The same data as are specified in paragraph (b)(2) of this section should be recorded.

(d) *Longitudinal control, flap retraction, section 4b.131 (b) (3).* The maneuver shown in paragraph (c)(2) of this section should be repeated with takeoff power on all engines.

(e) *Longitudinal control, power application, section 4b.131 (b) (4).*

(1) *Configuration.* This test should be conducted in the configuration that follows:

Weight—maximum landing.

C. G. position—most forward and most aft.

Wing flaps—retracted.

Landing gear—extended.

Engines—power off.

(2) *Test procedure and required data.* The airplane should be trimmed at a speed of  $1.4 V_{S1}$ ; takeoff power should be applied quickly without changing the airspeed. During this maneuver, it should be possible to control the airplane with one hand for a reasonable time without the necessity of changing the trim control. The same data as are specified in paragraph (b)(2) of this section should be recorded.

(f) *Longitudinal control, power application, section 4b.131 (b) (5).*

(1) *Configuration.* This test should be conducted in the configuration that follows:

Weight—maximum landing.

C. G. position—most forward and most aft.

Wing flaps—maximum landing position.

Landing gear—extended.

Engines—power off.

(2) *Test procedure and required data.* The airplane should be trimmed at a speed of  $1.4 V_{S1}$ ; takeoff power should be applied quickly without changing the airspeed. During this maneuver, it should be possible to control the airplane with one hand for a reasonable time without the necessity of changing the trim control. The same data as are specified in paragraph (b)(2) of this section should be recorded.

(g) *Longitudinal control, airspeed variation, section 4b.131 (b) (6).*

(1) *Configuration.* This test should be conducted in the configuration that follows:

Weight—maximum landing.

C. G. position—most forward.

Wing flaps—maximum landing position.

Landing gear—extended.

Engines—power off.

(2) *Test procedure and required data.* The airplane should be trimmed at a speed of  $1.4 V_{S1}$ , and it should be possible to control the airplane with one hand for a reasonable time without the necessity of changing the trim control when:

(i) The speed is reduced to  $1.1 V_{S1}$ ,

(ii) The speed is increased to  $1.7 V_{S1}$ , or to the placard flap speed.

In addition to the data specified in (b) (2) of this section, the recorded data should also include the airspeeds at  $1.1 V_{S1}$  and  $1.7 V_{S1}$  (or  $V_{FE}$  whichever is the lesser).

(h) *Longitudinal control, flap retraction and power application, section 4b.131 (c).*

(1) *Configuration.* This test should be conducted in the configuration that follows:

Weight—maximum landing.

C. G. position—most forward and most aft.

Wing flaps—maximum landing position.

Landing gear—extended.

Engines—power noted.

(2) *Test procedure and required data.* The airplane should be maintained in a steady horizontal flight at a speed of  $1.1 V_{S1}$ ; the flaps should be retracted from the maximum landing position with simultaneous application of not more than maximum continuous power. During this maneuver, it should be possible to prevent a loss of altitude without the use of exceptional piloting skill. The following data should be recorded:

Weight.

C. G. position.

Wing flap position.

Landing gear position.

Engines, r. p. m. and manifold pressure before and after tests.

Pressure altitude.

Ambient air temperature.

Airspeed at  $1.1 V_{S1}$ .

(19 F. R. 4454, July 26, 1954, effective Sept. 1, 1954; amended 24 F. R. 7067, Sept. 1, 1959, effective Oct. 1, 1959.)

#### 4b.132 *Directional and lateral control.*

(a) *Directional control; general.* It shall be possible, while holding the wings approximately level, to execute reasonably sudden changes in heading in either direction without encountering dangerous characteristics. Heading changes up to  $15^\circ$  shall be demonstrated, except that the heading change at which the rudder pedal force is 180 pounds need not be exceeded. The control shall be demonstrated at a speed equal to  $1.4 V_{S1}$ , under the following conditions:

(1) The critical engine inoperative and its propeller in the minimum drag position,

(2) Power required for level flight at  $1.4 V_{S1}$ , but not greater than maximum continuous power,

(3) Most unfavorable center of gravity position,

(4) Landing gear retracted,

(5) Wing flaps in the approach position,

(6) Maximum landing weight.

(b) *Directional control; four or more engines.* Airplanes with four or more engines shall comply with paragraph (a) of this section, except that:

(1) The two critical engines shall be inoperative, their propellers in the minimum drag position,

(2) The center of gravity shall be in the most forward position,

(3) The wing flaps shall be in the most favorable climb position.

(c) *Lateral control; general.* It shall be possible to execute  $20^\circ$  banked turns with and against the inoperative engine from steady flight at a speed equal to  $1.4 V_{S1}$ , with:

(1) The critical engine inoperative and its propeller in the minimum drag position,

(2) Maximum continuous power on the operating engines,

(3) Most unfavorable center of gravity position.

(4) Landing gear retracted and extended,

(5) Wing flaps in the most favorable climb position,

(6) Maximum takeoff weight.

(d) *Lateral control; four or more engines.* It shall be possible to execute  $20^\circ$  banked turns with and against the inoperative engines from steady flight at a speed equal to  $1.4 V_{S1}$ , with maximum continuous power and with the airplane in the configuration prescribed by paragraph (b) of this section.

(e) *Lateral control; all engines operating.* Roll response shall be rapid and of sufficient magnitude to perform normal maneuvers, such as recovery from upsets produced by gusts and the initiation of evasive maneuvers. In sideslips, up to sideslip angles which might be required in normal operation, sufficient excess lateral control shall remain to perform a limited amount of maneuvering and to correct for gusts. Lateral control shall be sufficient at all speeds up to  $[V_{rc}/M_{rc}]$  to provide a peak roll rate

necessary for safety without requiring excessive control forces or excessive control travel.

[(Amendment 4b-12, published 27 F. R. 2986, Mar. 3, 1962, effective May 3, 1962.)]

4b.132-1 *Procedure for demonstrating directional and lateral control (FAA policies which apply to sec. 4b.132).*

(a) *Appropriate instrumentation.* When conducting directional and lateral control tests, the airplane should contain appropriate instrumentation in order to obtain the following data:

(1) *Sections 4b.132 (a) and 4b.132 (b).* Instrumentation to indicate airplane heading angle and rudder force.

(2) *Sections 4b.132 (c) and 4b.132 (d).* Instrumentation to measure bank angle.

(b) *General test program.*

(1) *Directional control; general, section 4b.132 (a).*

(i) *Configuration.* This test should be conducted in the configuration that follows:

Weight—maximum landing.

C. G. position—most aft.

Wing flaps—approach position.

Landing gear—retracted.

Cowl flaps—appropriate for flight condition.

Operating engine(s)—power to maintain level flight at  $1.4 V_{S1}$ , but not more than maximum continuous power.

Critical inoperative engine—propeller feathered on engine most critical for controllability.

(ii) *Test procedure and required data.* The airplane should be trimmed as indicated above at any optional altitude (see sec. 4b.100-3 (c)). Reasonable sudden changes in heading to the left and right, using ailerons to maintain approximate level flight, should be made demonstrating a change of  $15^\circ$ , or the angle at which a dangerous condition is encountered, or at which 180 lbs. rudder force is required. The airplane should be satisfactorily controllable during this maneuver. The following data should be recorded:

Weight.

C. G. position.

Wing flap position.

Landing gear position.

Operating engine(s), r. p. m. and manifold pressure.



Position of critical inoperative engine and its propeller.

Pressure altitude.

Ambient air temperature.

Trim speed at  $1.4 V_{s1}$ .

Rudder force at maximum deflection.

(2) *Directional control; four or more engines, section 4b.132 (b).*

(i) *Configuration.* This test should be conducted in the configuration that follows:

Weight—maximum landing.

C. G. position—most forward.

Wing flaps—climb position.

Landing gear—retracted.

Operating engines—power required for level flight at  $1.4 V_{s1}$  but not more than maximum continuous power.

Critical inoperative engines—propellers feathered on outboard engine most critical for controllability and on adjacent engine.

(ii) *Test procedure and required data.*

The test procedure shown in subparagraph (1)(ii) of this paragraph should be repeated with two critical engines inoperative. In addition to the data specified in subparagraph (1)(ii) of this paragraph, the position of the critical inoperative engines and the propeller configuration should also be recorded.

(3) *Lateral control; general, section 4b.132 (c).*

(i) *Configuration.* This test should be conducted in the configuration that follows:

Weight—maximum takeoff.

C. G. position—most aft.

Wing flaps—climb position.

Landing gear—retracted and extended.

Operating engine(s)—maximum continuous power.

Critical inoperative engine—throttle closed on engine most critical for controllability, propeller feathered.

(ii) *Test procedure and required data.*

Banked turns of  $20^\circ$  should be demonstrated with and against the inoperative engine from a steady climb at  $1.4 V_{s1}$ . The following data should be recorded:

Weight.

C. G. position.

Wing flap position.

Landing gear position.

Engine(s), r. p. m. and manifold pressure.

Position of critical inoperative engine and its propeller.

Pressure altitude.

Ambient air temperature.

Trim speed at  $1.4 V_{s1}$ .

Rudder force at maximum deflection.

Aileron force at maximum deflection.

(4) *Lateral control; four or more engines, section 4b.132 (d).*

(i) *Configuration.* This test should be conducted in the configuration that follows:

Weight—maximum landing.

C. G. position—most forward.

Wing flaps—climb position.

Landing gear—retracted.

Operating engines—power required for level flight at  $1.4 V_{s1}$  but not more than maximum continuous power.

Critical inoperative engines—propellers feathered on outboard engine most critical for controllability and on adjacent engine.

(ii) *Test procedure and required data.*

Banked turns of  $20^\circ$  should be demonstrated with and against inoperative engines from steady flight at  $1.4 V_{s1}$ . The same data as are specified in subparagraph (3)(ii) of this paragraph should be recorded.

(19 F. R. 4455, July 20, 1954, effective Sept. 1, 1954.)

#### 4b.133 *Minimum control speed, $V_{MC}$ .*

(a) A minimum speed shall be determined under the conditions specified in this paragraph, so that when the critical engine is suddenly made inoperative at that speed it shall be possible to recover control of the airplane, with the engine still inoperative, and maintain it in straight flight at that speed, either with zero yaw or, at the option of the applicant, with an angle of bank not in excess of  $5^\circ$ . Such speed shall not exceed  $1.2 V_{s1}$  with:

(1) Take-off or maximum available power on all engines,

(2) Rearmost center of gravity,

(3) Flaps in takeoff position,

(4) Landing gear retracted,

(5) Cowl flaps in the position normally used during takeoff,

(6) Maximum sea level takeoff weight, or such lesser weight as may be necessary to demonstrate  $V_{MC}$ ,

(7) The airplane trimmed for takeoff,

(8) The propeller of the inoperative engine windmilling, except that a different position of the propeller shall be acceptable if the specific design of the propeller control makes it more logical to assume the different position,

(9) The airplane airborne and the ground effect negligible.

(b) In demonstrating the minimum speed of paragraph (a) of this section, the rudder force required to maintain control shall not exceed 180 pounds, and it shall not be necessary to throttle the remaining engines.

(c) During recovery of the maneuver of paragraph (a) of this section the airplane shall not assume any dangerous attitude, nor shall it require exceptional skill, strength, or alertness on the part of the pilot to prevent a change of heading in excess of  $20^\circ$  before recovery is complete.

NOTE: Interpretation No. 1 (17 F. R. 2112, Mar. 12, 1952), adopted by the Civil Aeronautics Board, Mar. 7, 1952, provides as follows:

(1) The Board interprets and construes subparagraph (8) of section 4b.133 (a) as requiring the Administrator to accept for the purposes of section 4b.133 a value for the one-engine-inoperative minimum control speed which has been established in accordance with the provisions of that section with the propeller of the inoperative engine feathered: *Provided*, That the airplane involved is equipped with an automatic feathering device acceptable to the Administrator under section 4b.10 for demonstrating compliance with the takeoff path and climb requirement of sections 4b.116 and 4b.120 (a) and (b).

4b.133-1 *Determination of the minimum control speed,  $V_{MC}$  (FAA policies which apply to sec. 4b.133).*

(a) When demonstrating the minimum control speed, the applicant may choose one of three basic methods dependent on the inherent characteristics of the airplane or a combination of the methods is acceptable provided that the combination chosen does not allow the aircraft to exceed any of the limiting factors specified in section 4b.133. These methods are:

(1) With wings level and 180 lbs. rudder force, or full rudder travel causing airplane to deviate from a constant heading, or airplane stall.

(2) With the wing on the engine operating side lowered  $5^\circ$  and 180 lbs. rudder force, or full rudder travel causing airplane to deviate from a constant heading, or airplane stall.

(3) At  $0^\circ$  yaw and full rudder travel causing airplane to deviate from zero degree yaw, or 180 lbs. rudder force, or airplane stall.

(b) When it has been found that the aircraft is limited by the 180 lbs. rudder force in any of the methods in paragraph (a) of this section, a plot of force vs. airspeed should be made through a suitable range of speeds to substantiate the speed chosen as  $V_{MC}$ .

(c) Generally speaking, in aircraft equipped with right-hand rotation propellers, the left-hand outboard engine is the most critical when inoperative from the standpoint of control. This condition should be substantiated, however, by a comparative test with both the right and then the left outboard engines inoperative, measuring the force necessary to hold the airplane within the limits as specified in section 4b.133 at or slightly above the minimum control speed. When conducting this test it is imperative to hold all remaining factors equal so that a true comparison may be accomplished.

(d) All testing should be accomplished at the appropriate weights and powers for the range of approval desired. The minimum control speed should be determined for each takeoff flap position selected for approval if the takeoff flap is made variable with altitude.

(e) Civil Air Regulation Part 4b, Interpretation No. 1, interprets section 4b.133 (a) (8) as requiring the establishment of one engine inoperative minimum control speed with the propeller of the inoperative engine feathered providing that the airplane is equipped with an automatic feathering device acceptable to the Administrator under section 4b.10 for demonstration of compliance with the takeoff path and climb requirements of sections 4b.116 and 4b.120 (a) and (b). In such cases where the applicant chooses to demonstrate  $V_{MC}$  with the propeller feathered, the value of  $V_{MC}$  with the propeller windmilling should also be obtained and included in the Airplane Flight Manual.

(f) *Configuration.* This test should be conducted in the configuration that follows:

Weight—maximum takeoff. (If stall occurs prior to reaching  $V_{MC}$ , applicant may

choose to demonstrate a lower  $V_{MC}$  at a reduced weight.)

C. G.—most aft.

Wing flaps—takeoff position.

Landing gear—retracted.

Operating engine(s)—takeoff r. p. m. and manifold pressure or full throttle, cowl flaps in takeoff position.

Inoperative engine—throttle closed, propeller windmilling or any other logical position, cowl flaps in takeoff position.

(g) *Test procedure and required data.* After establishing the critical inoperative engine and the choice of method for demonstration, the tests for establishing the minimum control speed may be conducted. Using the configuration specified in section 4b.133, all engines should be adjusted for takeoff power and a series of engine cuts made by moving the mixture control of the critical engine in idle cut-off position at consecutively lower airspeeds until one of the limiting factors specified in section 4b.133 is experienced. When the minimum control speed is determined, a minimum of five demonstrations should be made to provide adequate proof that the chosen value meets the requirement. The following data should be recorded:

Pressure altitude.

Ambient air temperature.

Indicated air speed.

Engines, r. p. m. and manifold pressure.

Torque pressure.

Carburetor air temperature.

Rudder force.

Bank angle.

Gyro direction indicator.

Yaw—if method is chosen where loss of airplane's ability to maintain  $0^\circ$  yaw is limiting factor specified in (a) (3) of this section.

(19 F. R. 4456, July 20, 1954, effective Sept. 1, 1954.)

### Trim

**4b.140 General.** The means used for trimming the airplane shall be such that after being trimmed and without further pressure upon, or movement of, either the primary control or its corresponding trim control by the pilot or the automatic pilot, the airplane shall comply with the trim requirements of sections 4b.141 through 4b.144.

**4b.140-1 General trim qualities (FAA policies which apply to sec. 4b.140).** It should be possible to trim the airplane completely for any flight condition which is reasonable to assume will be maintained steadily for any appreciable time. Compliance for unsymmetrical power should be demonstrated with "wings level" or "zero yaw" when a yawmeter is installed as a part of the required equipment.

**4b.141 Lateral and directional trim.** The airplane shall maintain lateral and directional trim under the most adverse lateral displacement of the center of gravity within the relevant operating limitations, under all normally expected conditions of operation, including operation at any speed from  $1.4 V_{S1}$  to  $[V_{MO}/M_{MO}]$ .

[(Amendment 4b-12, published 27 F.R. 2986 Mar. 30, 1962, effective May 3, 1962.)]

**4b.141-1. Procedure for demonstrating lateral and directional trim (FAA policies which apply to sec. 4b.141).**

(a) *Configuration.* This test should be conducted in the configuration that follows:

Weight—maximum takeoff and maximum landing.

C. G. position—most forward and most aft with greatest lateral variation in useful load. Asymmetrical fuel loading should be considered.

Wing flaps—retracted and maximum landing position.

Landing gear—retracted and extended.

Engines—power required for level flight.

Cowl flaps—appropriate for flight condition.

(b) *Test procedure and required data.* It should be possible to maintain hands-off lateral and directional trim when demonstrating compliance with section 4b.141. The following data should be recorded:

Weight.

C. G. position.

Wing flap position.

Landing gear position.

Engines, r. p. m. and manifold pressure.

Pressure altitude.

Ambient air temperature.

Trim speed at  $1.4 V_{S1}$ .

(Additional lateral and directional trim should be demonstrated in other con-

figurations in conjunction with tests in sec. 4b.150.)

(Amended 22 F. R. 6963, Aug. 29, 1957, effective Sept. 15, 1957.)

**4b.142 Longitudinal trim.** The airplane shall maintain longitudinal trim under the following conditions:

(a) During a climb with maximum continuous power at a speed not in excess of  $1.4 V_{S1}$  with the landing gear retracted and the wing flaps both retracted and in the takeoff position,

(b) During a glide with power off at a speed not in excess of  $1.4 V_{S1}$  with the landing gear extended and the wing flaps both retracted and extended, with the forward center of gravity position approved for landing with the maximum landing weight, and with the most forward center of gravity position approved for landing regardless of weight,

(c) During level flight at any speed from  $1.4 V_{S1}$  to  $[V_{MO}/M_{MO}]$ , with the landing gear and wing flaps retracted, and from  $1.4 V_{S1}$  to  $V_{LX}$  with the landing gear extended.

[Amendment 4b-12, published 27 F. R. 2986, Mar. 30, 1962, effective May 3, 1962.]

**4b.142-1 Procedure for demonstrating longitudinal trim (FAA policies which apply to sec. 4b.142).**

(a) *Longitudinal trim during climb, section 4b.142 (a).*

(1) *Configuration.* This test should be conducted in the configuration that follows:

Weight—maximum takeoff.

C. G. position—most forward.

Wing flaps—retracted and takeoff position.

Landing gear—retracted.

Engines—maximum continuous power.

Cowl flaps—optional.

(2) *Test procedure and required data.* It should be possible to maintain hands-off longitudinal trim at a speed not in excess of  $1.4 V_{S1}$  with the wing flaps retracted and in the takeoff position. The same data specified in section 4b.141-1 (b) should be recorded.

(b) *Longitudinal trim during glide, section 4b.142 (b).*

(1) *Configuration.* This test should be conducted in the configurations that follow:

Weight—maximum landing.

C. G. position—most forward for maximum landing weight.

Wing flaps—retracted and maximum landing position.

Landing gear—extended.

Engines—power off, propellers windmilling.

(2) *Test procedure and required data.* It should be possible to maintain hands-off longitudinal trim at a speed not in excess of  $1.4 V_{S1}$  with the wing flaps retracted and extended. This test should be repeated with the most forward c. g. position for landing regardless of weight. The same data specified in section 4b.141-1 (b) should be recorded.

(c) *Longitudinal trim during level flight, section 4b.142 (c).*

(1) *Configuration.* This test should be conducted in the configuration that follows:

Weight—maximum takeoff.

C. G. position—most forward and most aft.

Wing flaps—retracted.

Landing gear—retracted and extended.

Engines—power required for level flight.

Cowl flaps—appropriate for flight condition.

(2) *Test procedure and required data.* It should be possible to maintain hands-off longitudinal trim when demonstrating compliance with section 4b.142 (c).

(19 F. R. 4456, July 20, 1954, effective Sept. 1, 1954; amended 22 F. R. 6963, Aug. 29, 1957, effective Sept. 15, 1957.)

**4b.143 Longitudinal, directional, and lateral trim.**

(a) The airplane shall maintain longitudinal, directional, and lateral trim at a speed equal to  $1.4 V_{S1}$  during climbing flight with the critical engine inoperative, with:

(1) The remaining engine(s) operating at maximum continuous power,

(2) Landing gear retracted,

(3) Wing flaps retracted.

(b) In demonstrating compliance with the lateral trim requirement of paragraph (a) of this section, the angle of bank of the airplane shall not be in excess of 5 degrees.

**4b.143-1 Procedure for demonstrating longitudinal, directional, and lateral trim (FAA policies which apply to sec. 4b.143).**

(a) *Configuration.* This test should be conducted in the configuration that follows:

- Weight—maximum takeoff.
- C. G. position—most forward.
- Wing flaps—retracted.
- Landing gear—retracted.
- Cowl flaps—appropriate for flight condition.
- Operating engine(s)—maximum continuous power.
- Critical inoperative engine—throttle closed on engine most critical for trim, propeller feathered.

(b) *Test procedure and required data.* It should be possible to maintain hands-off longitudinal, directional, and lateral trim during climb at a speed of  $1.4 V_{S1}$ . In addition to the data specified in section 4b.141-1 (b), the position of the critical inoperative engine and its corresponding propeller should be recorded.

(19 F. R. 4457, July 20, 1954, effective Sept. 1, 1954.)

**4b.144 Trim for airplanes with four or more engines.** The airplane shall maintain trim in rectilinear flight at the climb speed, configuration, and power used in establishing the rates of climb in section 4b.121, with the most unfavorable center of gravity position, and at the weight at which the two-engine-inoperative climb is equal to at least  $0.01 V_{S0}^2$  at an altitude of 5,000 feet.

**4b.144-1 Procedure for demonstrating trim for airplanes with four or more engines (FAA policies which apply to sec. 4b.144).**

(a) *Configuration.* This test should be conducted in the configuration that follows:

- Weight—at which climb is equal to at least  $.01 V_{S0}^2$  at an altitude of 5,000 feet.
- C. G. position—most forward.
- Wing flaps—optional.
- Landing gear—retracted.
- Cowl flaps—appropriate for flight condition.
- Operating engines—maximum continuous power.
- Inoperative engines—throttles closed on outboard engine most critical for trim and on adjacent engine, propellers feathered.

(b) *Test procedure and required data.* It should be possible to maintain hands-off longitudinal, lateral, and directional trim at the same

airspeed used in demonstrating the two-engine-inoperative climb (see sec. 4b.121). The following data should be recorded:

- Weight.
- C. G. position.
- Wing flap position.
- Landing gear position.
- Operating engines, r. p. m., manifold pressure and cowl flap position.
- Position of critical inoperative engines and their propellers.
- Pressure altitude.
- Ambient air temperature.
- Climb speed.

(19 F. R. 4457, July 20, 1954, effective Sept. 1, 1954.)

## Stability

**[4b.150 General.** The airplane shall be longitudinally, directionally, and laterally stable in accordance with sections 4b.151 through 4b.158. Suitable stability shall be required in other conditions normally encountered in service if flight tests show such stability to be necessary for safe operation.]

[(Amendment 4b-12, published 27 F. R. 2986, Mar. 30, 1962, effective May 3, 1962.)]

**[4b.151 Static longitudinal stability.** In the conditions outlined in §§ 4b.152 through 4b.155, the characteristics of the elevator control forces including friction and the elevator control surface displacement shall comply with paragraphs (a) through (c) of this section.

**[(a)** A pull shall be required to obtain and maintain speeds below the specified trim speed, and a push shall be required to obtain and maintain speeds above the specified trim speed, except that if the elevator control forces are not dependent upon the hinge moments of the elevator control surface it shall also be shown that upward displacement of the elevator trailing edge is required to obtain and maintain speeds below the specified trim speed and a downward displacement of the elevator trailing edge is required to obtain and maintain speeds above the specified trim speed. These criteria shall apply to any speed which can be obtained, except that such speeds need not be greater than the landing gear or the wing flap operating limit speed or  $V_{FC}/M_{FC}$ , whichever is appro-

priate, or need not be less than the minimum speed in steady unstalled flight.]

(b) The airspeed shall return to within 10 percent of the original trim speed when the control force is slowly released from any speed within the limits defined in paragraph (a) of this section.

[(c) The stable slope of the stick force versus speed curve shall not be less than 0.5 pounds per 3 knots nor shall it exceed a value beyond which control of the airplane is difficult.]

[(Amendment 4b-12, published 27 F.R. 2986, Mar. 30, 1962, effective May 3, 1962.)]

**4b.152 Stability during landing.** The stick force curve and, if required by section 4b.151(a), the elevator angle curve shall have stable slopes and the stick force shall not exceed 80 pounds at any speed between  $1.1 V_{S_0}$  and  $1.8 V_{S_0}$  with:

- [(a) Wing flaps in the landing position;
- [(b) The landing gear extended;
- [(c) Maximum landing weight;
- [(d) Power, or thrust, off on all engines; and
- [(e) The airplane trimmed at  $1.4 V_{S_0}$  with power or thrust off.]

[(Amendment 4b-12, published 27 F.R. 2986, Mar. 30, 1962, effective May 3, 1962.)]

**4b.153 Stability during approach.** The stick force curve and, if required by section 4b.151(a), the elevator angle curve shall have stable slopes at all speeds between  $1.1 V_{S_1}$  and  $1.8 V_{S_1}$  with:

- [(a) Wing flaps in the approach position;
- [(b) Landing gear retracted;
- [(c) Maximum landing weight; and
- [(d) The airplane trimmed at  $1.4 V_{S_1}$  and with power sufficient to maintain level flight at this speed.]

[(Amendment 4b-12, published 27 F.R. 2986, Mar. 30, 1962, effective May 3, 1962.)]

**4b.154 Stability during climb.** The stick force curve and, if required by section 4b.151(a), the elevator angle curve shall have stable slopes at all speeds between 85 and 115 percent of the speed at which the airplane is trimmed with:

- [(a) Wing flaps retracted;
- [(b) Landing gear retracted;

[(c) Maximum takeoff weight;

[(d) 75 percent of maximum continuous power for reciprocating engines; maximum power or thrust selected by the applicant as an operating limitation for use during climb (see sec. 4b.718) for turbine engines; and

[(e) The airplane trimmed at the best rate-of-climb speed except that the speed need not be less than  $1.4 V_{S_1}$ .]

[(Amendment 4b-12, published 27 F.R. 2986, Mar. 30, 1962, effective May 3, 1962.)]

**4b.155 Stability during cruising.**

[(a) *Landing gear retracted; high speed.* The stick force curve and, if required by section 4b.151(a), the elevator angle curve shall have stable slopes at all speeds from  $V_{FC}/M_{FC}$  to the speed equal to  $V_{FC} - \left( \frac{V_{FC} - 1.4 V_{S_1}}{2} \right)$  or to 50 knots less than the trim speed specified in subparagraph (4) of this paragraph whichever is the lesser speed except that it need not be less than  $1.4 V_{S_1}$ , and the stick force shall not exceed 50 pounds with:

- [(1) Wing flaps retracted;
- [(2) The most critical weight between maximum landing weight and maximum take-off weight;

[(3) 75 percent of maximum continuous power for reciprocating engines; maximum cruising power selected by the applicant as an operating limitation (see sec. 4b.718) for turbine engines, except that the power need not exceed that required at  $V_{MO}/M_{MO}$ ; and

[(4) The airplane trimmed for level flight with the power required in subparagraph (3) of this paragraph.

[(b) *Landing gear retracted; low speed.* The stick force curve and, if required by section 4b.151(a), the elevator angle curve shall have stable slopes at all speeds from a speed equal to

$$V_{FC} - \left( \frac{V_{FC} - 1.4 V_{S_1}}{2} \right)$$

to  $1.4 V_{S_1}$  and the stick force shall not exceed 50 pounds with the wing flaps and weight as specified in paragraph (a) of this section and with:

- [(1) Power required for level flight at a speed equal to  $V_{FC} - \left( \frac{V_{FC} - 1.4 V_{S_1}}{2} \right)$ ; and

[(2) The airplane trimmed for level flight with the power required in subparagraph (1) of this paragraph.

NOTE: At altitudes where Mach number is critical, the calibrated airspeed corresponding with  $M_{FC}$  may be used to calculate the speed

$$V_{FC} = \left( \frac{V_{FC=1.4} V_{s1}}{2} \right)$$

[(c) *Landing gear extended.* The stick force curve and, if required by section 4b.151(a), the elevator angle curve shall have stable slopes at all speeds between  $1.4 V_{s1}$  and  $V_{LE}$  and the stick force shall not exceed 50 pounds with the wing flaps and the weight as specified in paragraph (a) of this section and with:

[(1) Power required for level flight at  $V_{LE}$ ; and

[(2) The airplane trimmed for level flight with the power required in subparagraph (1) of this paragraph.]

[(Amendment 4b-12, published 27 F. R. 2986; Mar. 30, 1962, effective May 3, 1962.)]

**4b.156 *Dynamic longitudinal stability.*** Any short period oscillation occurring between stalling speed and maximum permissible speed appropriate to the configuration of the airplane [e.g.,  $V_{FE}$ ,  $V_{LE}$ , or  $V_{FC}/M_{FC}$ ] shall be heavily damped with the primary controls free and in a fixed position.

[(Amendment 4b-12, published 27 F. R. 2986, Mar. 30, 1962, effective May 3, 1962.)]

**4b.156-1 *Procedure for demonstrating dynamic longitudinal stability (FAA policies which apply to sec. 4b.156).*** Damping of accelerations and movement of the control should be noted when:

(a) The control column is quickly offset and immediately released and

(b) The control column is quickly offset and immediately returned to the trim position and held in this position.

(19 F. R. 4458, July 20, 1954, effective Sept. 1, 1954.)

**4b.157 *Static directional and lateral stability.***

(a) The static directional stability, as shown by the tendency to recover from a skid with rudder free, shall be positive with all landing gear and flap positions and symmetrical power conditions, at all speeds from  $1.2 V_{s1}$  up to [ $V_{FE}$ ,  $V_{LE}$ , or  $V_{FC}/M_{FC}$ , whichever is appropriate to the airplane configuration].

(b) The static lateral stability, as shown by the tendency to raise the low wing in a sideslip with the aileron controls free and with all landing gear and flap positions and symmetrical power conditions, shall:

(1) Be positive at [ $V_{FE}$ ,  $V_{LE}$ , or  $V_{FC}/M_{FC}$ , whichever is appropriate to the airplane configuration],

(2) Not be negative at a speed equal to  $1.2 V_{s1}$ .

(c) In straight steady sideslips (unaccelerated forward slips) the aileron and rudder control movements and forces shall be substantially proportional to the angle of sideslip, and the factor of proportionality shall lie between limits found necessary for safe operation throughout the range of sideslip angles appropriate to the operation of the airplane. At greater angles up to that at which the full rudder control is employed or a rudder pedal force of 180 pounds is obtained, the rudder pedal forces shall not reverse and increased rudder deflection shall produce increased angles of sideslip. Sufficient bank shall accompany sideslipping to indicate clearly any departure from steady unyawed flight, unless a yaw indicator is provided.

[(Amendment 4b-12, published 27 F. R. 2985, Mar. 30, 1962, effective May 3, 1962.)]

**4b.157-1 *Procedure for demonstrating static directional and lateral stability (FAA policies which apply to sec. 4b.157).***

(a) *Motion involving roll.* No real motion of the airplane involving roll is possible without yaw also being involved, and vice versa. In showing compliance with section 4b.157 the rolling and yawing stability should be investigated separately.

(b) *Directional stability.* Directional stability should be investigated by starting from steady flight in the required configuration and deflecting the rudder at a fairly rapid rate by the amount required to maintain a steady skid with the airplane yawed approximately  $20^\circ$  (as read on the directional gyro) while the wings are maintained level by use of the ailerons, and the speed held constant by means of the elevator control. When the steady condition has been established, the rudder should be released and, if the airplane is directionally stable, it should cease to skid; i.e., the yaw should decrease to

approximately zero and, if also laterally stable the aileron deflection and force required to hold the wings level should also approach zero. The test should be conducted by executing skids both to the right and left, recording in each case the time required from the release of the rudder controls and the number of oscillations, if any, involved to recover to steady level flight.

(c) *Lateral stability.* Lateral stability should be investigated by starting from steady flight in the required configuration and banking the airplane approximately  $20^\circ$  (as read on the gyro horizon) by means of the ailerons, while maintaining the original heading by means of the rudder, and the original speed by means of the longitudinal trimming device. When the steady slipping condition has been established, the aileron control should be released. If the airplane is laterally stable, it should cease to slip; i. e., the wing should return to an approximately level attitude, and the rudder deflection and pedal force required to maintain the heading should approach zero. The test should be conducted by executing slips from both to right and left, and in each case the time required from the release of the aileron control and the number of oscillations, if any, involved to recover to steady level flight should be recorded.

(d) *Additional test.* In addition to the directional and lateral stability tests, section 4b.157(c) contains provisions which should be used to test the airplane for rudder overbalance.

(e) *Static directional stability test, section 4b.157 (a) and (c).* **CAUTION:** Prior to conducting this test and that in paragraph (f) of this section, complete agreement should be reached between the applicant and the FAA Flight Test Inspector to insure that the severity of control application will not result in loads exceeding the design limitations.

(1) *Configuration.* This test should be conducted in the configurations that follow:

Maximum takeoff weight with wing flaps retracted.

Maximum landing weight with wing flaps extended.

C. G. position—most aft.

Wing flaps—retracted and maximum landing position.

Landing gear—retracted and extended.

(2) *Test procedure and required data.* The following tests should be conducted at the altitude deemed most critical for the combination of power and aerodynamic damping effect:

(i) The airplane should be yawed slowly to the left and right using ailerons to hold wings level, and, when controls are released slowly, the tendency of airplane to recover from the skid should be noted.

(ii) The qualitative proportionality of rudder and aileron deflection and force during steady straight sideslips should be noted.

(iii) Damping of yawing and movement of control should be noted when the rudder is quickly offset and immediately released and when the rudder is quickly offset and immediately returned and held in the trim position.

(f) *Static lateral stability test, section 4b.157(b).*

(1) *Configuration.* This test should be conducted in the configurations that follow:

Maximum takeoff weight with flaps retracted.

Maximum landing weight with flaps extended.

C. G. position—most aft.

Wing flaps—retracted and maximum landing position.

Landing gear—retracted and extended.

(19 F. R. 4458, July 20, 1954, effective Sept. 1, 1954; amended 22 F. R. 6963, Aug. 29, 1957, effective Sept. 15, 1957; [27 F. R. 2986, Mar. 30, 1962, effective May 3, 1962.]

**4b.158 *Dynamic directional and lateral stability.* Any short period oscillation occurring between stalling speed and maximum permissible speed appropriate to the configuration of the airplane [(e.g.,  $V_{FE}$ ,  $V_{LE}$ , or  $V_{FC}/M_{FC}$ )] shall be heavily damped with the primary controls free and in a fixed position.**

[(Amendment 4b-12, published 27 F.R. 2986, Mar. 30, 1962, effective May 3, 1962.)]

4b.158-1 *Procedure for demonstrating dynamic directional and lateral stability (FAA policies which apply to sec. 4b.158).* Damping of yawing and movement of the control should be noted during the test procedure in section 4b.157-1 (e) (2) (iii).

(19 F. R. 4459, July 20, 1954, effective Sept. 1, 1954.)



## Stalling Characteristics

### 4b.160 *Stalling; symmetrical power.*

(a) Stalls shall be demonstrated with the airplane in straight flight and in banked turns at 30 degrees, both with power off and with power on. In the power-on conditions the power shall be that necessary to maintain level flight at a speed of  $1.6 V_{s1}$ , where  $V_{s1}$  corresponds with the stalling speed with flaps in the approach position, the landing gear retracted, and maximum landing weight.

(b) The stall demonstration shall be in the following configurations:

- (1) Wing flaps and landing gear in any likely combination of positions,
- (2) Representative weights within the range for which certification is sought,
- (3) The center of gravity in the most adverse position for recovery.

(c) The stall demonstration shall be conducted as follows:

(1) [With the airplane trimmed for straight flight at the speed prescribed in section 4b.112 (c) (1)], the speed shall be reduced by means of the elevator control until it is steady at slightly above stalling speed; after which the elevator control shall be applied at a rate such that the airplane speed reduction does not exceed one mile per hour per second until the airplane is stalled or, if the airplane is not stalled, until the control reaches the stop.

(2) The airplane shall be considered stalled when, at an angle of attack measurably greater than that of maximum lift, the inherent flight characteristics give a clear indication to the pilot that the airplane is stalled, except that for airplanes demonstrating unmistakable inherent aerodynamic warning associated with the stall in all required configurations, the speed

need not be reduced below a value which provides an adequate stall warning margin as defined in section 4b.162.

NOTE: A nose-down pitch or a roll which cannot be readily arrested are typical indications, that the airplane is stalled. Other indications such as marked loss of control effectiveness, abrupt change in control force or motion, characteristic buffeting, or a distinctive vibration of the pilot's controls, may be accepted if found in a particular case to be sufficiently clear. Types of inherent aerodynamic warning considered acceptable included characteristics such as buffeting, small amplitude pitch or roll oscillations, distinctive shaking of the pilot's control, etc.

(3) Recovery from the stall shall be effected by normal recovery techniques, starting as soon as the airplane is stalled.

(d) During stall demonstration it shall be possible to produce and to correct roll and yaw by unreversed use of the aileron and rudder controls up to the moment the airplane is stalled; there shall occur no abnormal nose-up pitching; and the longitudinal control force shall be positive up to and including the stall.

[(e) Straight flight stalls shall be entered with wings level. The roll occurring between the stall and the completion of the recovery shall not exceed approximately 20 degrees.]

(f) In turning flight stalls the action of the airplane following the stall shall not be so violent or extreme as to make it difficult with normal piloting skill to effect a prompt recovery and to regain control of the airplane.

(g) In both the straight flight and the turning flight stall demonstrations it shall be possible promptly to prevent the airplane from stalling and to recover from the stall condition by normal use of the controls.

[(Amendment 4b-12, published 27 F. R. 2986, Mar. 30, 1962, effective May 3, 1962.)]

## Discussion of Policies Relating to Procedure for Demonstrating Stall Tests, Symmetrical Power in Section 4b.160-1

Flight tests have shown that the point of maximum lift in the time-history data may be obtained with sufficient accuracy from an accelerometer mounted perpendicular to the wing MAC axis if excessive angles-of-attack are not obtained. Mounting an accelerometer in this manner, however, gives acceleration along the normal force vector and not along the lift vector. This results in acceleration readings which are affected by longitudinal acceleration. Nevertheless, if a deceleration rate of not greater than 1 m. p. h./sec.  $\left(\frac{1 \times 1.467}{32.2} = .05g\right)$

is maintained in the stall maneuver, the effect of longitudinal acceleration will be negligible.

Indicated acceleration is affected by the angle which the vertical axis of the accelerometer makes with a perpendicular to the earth's surface. Thus, for very high stall angles an accelerometer mounted perpendicular to the MAC will indicate a decrease in load factor merely due to rotation of the instrument. Since it is theoretically desirable to obtain acceleration along the lift vector (perpendicular to the flight path), and since tests have shown that the flight path during the stall maneuver is approximately level regardless of configuration down to the stall, it seems obvious that mounting the accelerometer so that its vertical axis is offset from a line perpendicular to the wing MAC by an angle equal to the angle-of-attack for  $C_L$  max. will reduce error due to improper orientation of the accelerometer axis. At angle-of-attack for  $C_L$  max.,  $L = \eta W$  if angle-of-attack for  $C_L$  max. was properly chosen; the error in lift either side of  $L_{max}$ , will be off by the cosine of the angular difference between the actual angle-of-attack and the angle at which the accelerometer was set. Calculations show that any reasonable angular error in setting the accelerometer will not significantly affect the shape or location of the lift curve peak.

In regard to measurement of angle-of-attack, determination of true angle-of-attack would require calibration of the indicator for each of several configurations. However, compliance with the regulation does not require knowledge of true angle-of-attack but only assurance that true angle-of-attack is increasing steadily as the maximum lift is exceeded. Since calibration of known angle-of-attack devices shows that the difference between true angle and indicated angle is proportional to  $C_L$ , then knowledge of variation of indicated angle-of-attack during the stall maneuver will be sufficient.

4b.160-1 *Procedure for demonstrating stall tests, symmetrical power (FAA policies which apply to sec. 4b.160 (c) (2)).*

(a) *Angle-of-attack.* The angle-of-attack during the stall maneuver should be increased at least to the point where the following two conditions are satisfied:

(1) Attainment of an angle-of-attack measurably greater than that for maximum lift.

(2) Clear indication to the pilot through the inherent flight characteristics that the airplane is stalled.

(b) *Procedure to be used.* The following procedure may be used to demonstrate that these two conditions are fulfilled:

(1) A photopanel or equivalent method of obtaining continuous records of the following variables at not greater than  $\frac{1}{4}$  second intervals should be provided: indicated angle-of-attack, swivel static and shielded total pressure head or equivalent, pressure altitude, pitch and bank angle, normal acceleration, elevator position and force, aileron and rudder position.

(2) If it is evident that longitudinal stick force is always positive, that is, no reversal exists down to the stall, then time history of this item should not be required.

(3) In order to insure that an accurate recording of the indicated angle-of-attack is obtained, the sensing device should be located in a region where tuft surveys show that the streamlines undergo no radical change in direction up to the maximum angle contemplated. Regions well forward of the wing leading edge are desirable to keep the angular difference between true angle and indicated angle as small as possible.

(4) Means for indicating the stall-warning point and the point at which the pilot is informed by the inherent flight characteristics that the airplane is stalled should be provided. This may consist of a light on the photopanel operable by a switch mounted on the control wheel. In order to insure that the camera records the light image a time delay device may need to be incorporated in the light circuit in cases where camera speed is low.

(c) *Configuration.* Stalls should be conducted in the configurations noted in the following listings and with cowl flaps appropriate for the flight condition. Power-off stalls should be conducted with the engines idling and propellers in low pitch. For power-on conditions, stalls should be conducted with that power necessary to maintain level flight at a speed of  $1.6 V_s$ , with flaps in the approach position, landing gear retracted and maximum landing weight.

(1) Stalls—straight flight:

Gross weight	C. G.	Power	Positions	
			Flap	Gear
Max. Land...	Most Fwd.	Off	Retr.	Retr. <sup>1</sup>
Do.....	do.....	do	T. O.	Do. <sup>1</sup>
Do.....	do.....	do	Appr.	Do. <sup>1</sup>
Do.....	do.....	do	Land.	Ext. <sup>1</sup>
Do.....	do.....	On	Appr.	Do. <sup>2</sup>
Do.....	do.....	do	Land.	Do. <sup>2</sup>
Do.....	Most Aft.	Off	Appr.	Do. <sup>2</sup>
Do.....	do.....	do	Land.	Do. <sup>2</sup>
Do.....	do.....	On	Appr.	Retr.
Do.....	do.....	do	do	Ext.
Do.....	do.....	do	Land.	Retr.
Do.....	do.....	do	do	Ext.
Max. T. O.	do.....	Off	Retr.	Ext. <sup>2</sup>
Do.....	do.....	do	T. O.	Do. <sup>2</sup>
Do.....	do.....	On	Retr.	Do. <sup>2</sup>
Do.....	do.....	do	T. O.	Do. <sup>2</sup>

<sup>1</sup> May be demonstrated during stalling speed tests. See section 4b.112.

<sup>2</sup> Use extended, unless, due to direction of C. G. shift with gear, retracted gear is more critical. If retracted is more critical use retracted position for these stalls.

(2) Stalls—30° banked turns:

Gross weight	C. G.	Power	Positions		Direction
			Flap	Gear	
Max. T. O.	Most Aft	Off	Retr.	Retr.	To right
Do.....	do.....	do	do	do	To left
Do.....	do.....	On	do	do	To right
Do.....	do.....	do	do	do	To left
Max. Land.	do.....	Off	Land.	Extend.	To right
Do.....	do.....	do	do	do	To left
Do.....	do.....	On	do	do	Do.
Do.....	do.....	do	do	do	To right

(d) *Test procedure and required data.* The stall tests may be conducted at any optional altitude (see sec. 4b.100-3 (d)). The flight test procedure should be conducted in accordance with section 4b.160 (c) (1). The pilot should be provided with a yawmeter or equivalent

means for maintaining the angle of yaw as near zero as possible. The operation of the photopanel recording system, previously described in paragraph (b) (1) of this section, should be started at least 20 m.p.h. above the stall speed and allowed to operate continuously until the stall recovery is completed. The pilot's indication of stall warning and the actual occurrence of the stall should be obtained. In addition to the data obtained on the photopanel shown in (b) (1) of this section, the following information should also be recorded:

Weight.

C. G. position.

Ambient air temperature.

Wing flap position.

Landing gear position.

Engines, r. p. m. and manifold pressure.

(e) *Data analysis.* Time histories should be plotted of the photopanel instruments. The stalling warning point (see sec. 4b.162-1) and the point at which "the inherent flight characteristics give a clear indication that the airplane is stalled" should be noted on the plots.

(1) Inspection of the plots will then show if the following two conditions are fulfilled:

(i) The indicated angle-of-attack increases steadily to a value measurably beyond that for maximum lift, and

(ii) The stall is evident to the pilot prior to initiation of recovery.

(2) Consideration should be given to the following points in the time-history analysis:

(i) The direction in which the elevator is moving, i. e., any nose down pitch or decrease in load factor not induced by inadvertent elevator motion,

(ii) Rudder and aileron movement with respect to uncontrollable roll,

(iii) The effect of lag in the airspeed system,

(iv) Rate of airspeed change,

(v) Effect of pitching velocity or rolling velocity on indicated angle-of-attack. If possible, angle-of-attack time history should be drawn through points where pitching or rolling velocity are small. If corrections are unavoidable, the angular correction is simply  $\tan^{-1} \text{pd}/V$  where p is the rolling or pitching velocity,

V is the true airspeed, and d is the distance from the pitch or rolling axis, as the case may be, to the sensing device. It should be noted that this correction is applicable to either true or indicated angle-of-attack.

(vi) The indicated acceleration is a function of the angle the vertical axis of the accelerometer makes with the perpendicular to the earth's surface. Therefore, bank angle will seriously affect the maximum lift point. For example, a bank of 45° without loss of lift will result in a drop in indicated acceleration from 1.00 to .707. As a result acceleration data obtained in the region of  $C_{L_{max}}$  should be disregarded or corrected for bank angle when the bank angle exceeds nine or ten degrees.

(19 F. R. 4459, July 20, 1954, effective Sept. 1, 1954.)

#### 4b.161 *Stalling; asymmetrical power.*

(a) The airplane shall be safely recoverable without applying power to the inoperative engine when stalled with:

- (1) The critical engine inoperative,
- (2) Flaps and landing gear retracted,
- (3) The remaining engines operating up to

75 percent of maximum continuous power, except that the power need not be greater than that at which the wings can be held level laterally with the use of maximum control travel.

(b) It shall be acceptable to throttle back the operating engines during the recovery from the stall.

4b.161-1 *Procedure for demonstrating stall tests, asymmetrical power (FAA policies which apply to sec. 4b.161).*

(a) *Control of airplane.* During this test the airplane should not become uncontrollable or lose an excessive amount of altitude when so stalled.

(b) *Configuration.* This test should be conducted in the configuration that follows:

Weight—maximum takeoff.

C. G. position—most aft.

Wing flaps—retracted.

Landing gear—retracted.

Operating engine(s)—power up to 75 percent maximum continuous power, cowling flaps optional.

Critical inoperative engine—propeller optional, feathered or windmilling, cowling flaps appropriate for flight condition.

Trim speed— $1.4 V_{s1}$ .

(c) *Test procedure and required data.* This test may be conducted at any optional altitude (see sec. 4b.100-3 (c)). See section 4b.160 (c) regarding test procedure.

(1) The speed of the airplane should be reduced from the trim condition with the wings held level until the first of the following occurs:

- (i) Full rudder or aileron deflection.
- (ii) 180 lbs. rudder force.
- (iii) Stall is reached.

(2) If full rudder or aileron deflection, or the 180 lbs. rudder force occurs first, the power should be reduced and the test repeated until sufficient control is available to complete the stall. The power may be reduced on the operating engine(s) before reapplying power on the operating engine or engines for the purpose of regaining level flight. The following data should be recorded at that point:

Pressure altitude.

Ambient air temperature.

Indicated air speed.

Engines, r. p. m. and manifold pressure.

Torque pressure.

Carburetor air temperature.

Rudder force (if desirable).

(3) If stall is reached first, the same data should be recorded.

(19 F. R. 4460, July 20, 1954, effective Sept. 1, 1954.)

4b.162 *Stall warning.* Clear and distinctive stall warning shall be apparent to the pilot with sufficient margin to prevent inadvertent stalling of the airplane with flaps and landing gear in all normally used positions, both in straight and in turning flight. It shall be acceptable for the warning to be furnished either through the inherent aerodynamic qualities of the airplane or by a device which will give clearly distinguishable indications under all expected conditions of flight.

NOTE: A stall warning beginning at a speed 7 percent above the stalling speed is normally considered sufficient margin. Other margins may be acceptable depending upon the degree of clarity, duration, and distinctiveness of the warning and upon other characteristics of the airplane evidenced during the approach to the stall.

### Discussion of Policies Relating to Stall Warning in Section 4b.162-1

Occurrence of stall warning at some specific speed margin above the stalling speed is no longer required. It has been found that certain other characteristics may exist which make an airplane less susceptible to inadvertent stalling than one in which a specific speed margin has been provided between the occurrence of stall warning and the actual stall.

4b.162-1 *Stall warning (FAA policies which apply to sec. 4b.162).*

(a) The adequacy of stall warning should depend on the relative ease with which an airplane might be inadvertently stalled following the occurrence of stall warning. For example, if unmistakable warning occurs only 2 percent above the stall speed but undue pilot effort is required to reduce the airspeed to the stall, the speed margin of 2 percent may be adequate. On the other hand, if conscious effort is required to avoid stalling the airplane, a positive type of warning initiated at a relatively high speed above the stall may be required.

(b) Suggested suitable stall warnings are, buffeting which may be defined as general shaking or vibration of the airplane or elevator shake of sufficient magnitude to be unmistakable; or a stall warning instrument such as a stick shaker. A visual stall warning device which requires the attention of the crew within the cockpit is not considered acceptable by itself.

(19 F. R. 4460, July 20, 1954, effective Sept. 1, 1954.)

### Ground Handling Characteristics

4b.170 *Longitudinal stability and control.*

(a) There shall be no uncontrollable tendency for landplanes to nose over in any reasonably expected operating condition or when rebound occurs during landing or takeoff.

(b) Wheel brakes shall operate smoothly and shall exhibit no undue tendency to induce nosing over.

(c) When a tail-wheel landing gear is used it shall be possible during the takeoff ground run on concrete to maintain any attitude up to thrust line level at 80 percent of  $V_{s1}$ .

4b.170-1 *Procedure for demonstrating longitudinal stability and control on the ground (FAA policies which apply to sec. 4b.170).* Taxiing

tests at velocities up to 70 percent of the stalling speed should be conducted on smooth and rough ground which may likely be encountered under normal operating conditions. Particular attention should be paid to the following:

(a) *Taxiing over rough ground.* There is some evidence to indicate that critical loads can be built up in taxiing over rough ground, even when the shock-absorbing system is entirely satisfactory with respect to capacity for landing purposes.

(b) *Brakes.* Their adequacy when maneuvering on the ground and their tendency to cause nosing-over should be investigated. Any bad tendency will normally be exaggerated when taxiing in a strong side or tail wind.

(19 F. R. 4460, July 20, 1954, effective Sept. 1, 1954.)

4b.170-2 *Longitudinal stability and control with reverse thrust (FAA policies which apply to sec. 4b.170).* The policies outlined in section 4b.402-1 (a), (d), and (e) will apply.

(20 F. R. 2277, Apr. 8, 1955, effective Apr. 30, 1955.)

4b.170-3 *Longitudinal stability and control with an antiskid device installed (FAA policies which apply to sec. 4b.170).* The policies outlined in section 4b.337-4 will apply.

(21 F. R. 2558, Apr. 19, 1956, effective May 15, 1956.)

4b.171 *Directional stability and control.*

(a) There shall be no uncontrollable ground-looping tendency in 90° cross winds of velocity up to 0.2  $V_s$ , at any ground speed at which the airplane is expected to operate.

(b) All landplanes shall be demonstrated to be satisfactorily controllable with no exceptional degree of skill or alertness on the part of the pilot in power-off landings at normal landing speed during which brakes or engine power are not used to maintain a straight path.

(c) Means shall be provided for directional control of the airplane during taxiing.

4b.171-1 *Procedure for demonstrating directional stability and control on the ground (FAA policies which apply to sec. 4b.171).*

(a) Compliance with the requirement of section 4b.171 (a) may be demonstrated during tests for the establishment of the cross wind component velocity in accordance with section 4b.173.

(b) Compliance with the requirement of section 4b.171 (b) may be demonstrated during power-off landings in other tests.

(c) Compliance with the requirement of section 4b.171 (c) may be demonstrated during taxiing prior to takeoff or after landing from other flight tests.

(19 F. R. 4460, July 20, 1954, effective Sept. 1, 1954.)

4b.171-2 *Directional stability and control with reverse thrust (FAA policies which apply to sec. 4b.171).* The policies outlined in section 4b.402-1 (a), (d), and (e) will apply.

(20 F. R. 2277, Apr. 8, 1955, effective Apr. 30, 1955.)

4b.171-3 *Directional stability and control with an antiskid device installed (FAA policies which apply to sec. 4b.171).* The policies outlined in section 4b.337-4 will apply.

(21 F. R. 2558, Apr. 19, 1956, effective May 15, 1956.)

**4b.172 Shock absorption.** The shock absorbing mechanism shall not produce damage to the structure when the airplane is taxied on the roughest ground which it is reasonable to expect the airplane to encounter in normal operation.

4b.172-1 *Shock absorbing mechanism tests (FAA policies which apply to sec. 4b.172).* The shock absorbing mechanism should be checked for satisfactory operation while taxiing, taking off and landing during other tests in the type certification program.

(19 F. R. 4460 July 20, 1954, effective Sept. 1, 1954.)

**4b.173 Demonstrated crosswind.** There shall be established a cross component of wind velocity at which it has been demonstrated to be safe to take off or land.

4b.173-1 *Crosswind demonstration (FAA policies which apply to sec. 4b.173).*

(a) *Crosswind component.* A crosswind component of not less than  $0.2 V_{s_0}$  should be

established during type tests. (Consequently, two results are possible:

(1) A crosswind component may be established at a value which is not marginal with the airplane's handling characteristics. This value should be included in the Operating Procedures section of the Airplane Flight Manual. The operation of the aircraft in crosswinds greater than the value specified is not necessarily a hazard. Thus operation in crosswinds of a greater value is entirely within the discretion of the operator.

(2) A critical crosswind component may be established at a value which is considered the maximum up to which it is safe to operate the airplane on the ground, including takeoffs and landings. This value should be shown in the Operating Limitations section of the Airplane Flight Manual. Operation of the airplane in crosswinds above the maximum safe value is considered hazardous and the operator should do so only on the same emergency basis that a pilot would be justified in exceeding any of the operating limitations such as air speed, engine r. p. m., c. g. limitations, etc.

(3) An operator may of course restrict the operation of his airplane to crosswind components of any value equal to or less than that established during the type certification tests.

(b) *Configuration.* This test should be conducted in the configurations that follow:

Weight—maximum takeoff and landing.

C. G. position—most aft.

Flaps—takeoff and maximum landing positions.

(c) *Test procedure and required data.* At least three takeoffs and landings should be made in crosswind components of  $0.2 V_{s_0}$  mph (or greater at applicant's option) to demonstrate satisfactory controllability and handling characteristics. The magnitude and direction of the crosswind should be established by the use of appropriate meteorological instruments.

(19 F. R. 4460, July 20, 1954, effective Sept. 1, 1954.)

4b.173-2 *Ground handling characteristics with reverse thrust (FAA policies which apply to sec. 4b.173).* The policies outlined in section 4b.402-1 (a) and (d) will apply.

(20 F. R. 2278, Apr. 8, 1955, effective Apr. 30, 1955.)

## Water Handling Characteristics

**4b.180 Water conditions.** The most adverse water conditions in which the seaplane has been demonstrated to be safe for takeoff, taxiing, and alighting shall be established.

**4b.180-1 Water handling qualities (FAA policies which apply to sec. 4b.180).** Policies outlined in section 4b.182-1 will apply.

(19 F. R. 4461, July 20, 1954, effective Sept. 1, 1954.)

**4b.181 Wind conditions.** The following wind velocities shall be established:

(a) A lateral component of wind velocity not less than  $0.2 V_{S_0}$  at and below which it has been demonstrated that the seaplane is safe for taking off and alighting under all water conditions in which the seaplane is likely to be operated;

(b) A wind velocity at and below which it has been demonstrated that the seaplane is safe in taxiing in all directions, under all water conditions in which the seaplane is likely to be operated.

**4b.181-1 Crosswind demonstration (FAA policies which apply to sec. 4b.181).** Policies outlined in section 4b.173-1 will apply.

(19 F. R. 4461, July 20, 1954, effective Sept. 1, 1954.)

**4b.182 Control and stability on the water.**

(a) In taking off, taxiing, and alighting, the seaplane shall not exhibit the following:

(1) Any dangerously uncontrollable porpoising, bouncing, or swinging tendency;

(2) Any submerging of auxiliary floats or sponsons, any immersion of wing tips, propeller blades, or other parts of the seaplane which are not designed to withstand the resulting water loads;

(3) Any spray forming which would impair the pilot's view, cause damage to the seaplane, or result in ingress of an undue quantity of water.

(b) Compliance with paragraph (a) of this section shall be shown under the following conditions:

(1) All water conditions from smooth to the most adverse condition established in accordance with section 4b.180;

(2) All wind and cross-wind velocities, water currents, and associated waves and

swells which the seaplane is likely to encounter in operation on water;

(3) All speeds at which the seaplane is likely to be operated on the water;

(4) Sudden failure of the critical engine, occurring at any time while the airplane is operated on water;

(5) All seaplane weights and center of gravity positions within the range of loading conditions for which certification is sought, relevant to each condition of operation.

(c) In the water conditions of paragraph (b) of this section and the corresponding wind conditions the seaplane shall be able to drift for 5 minutes with engines inoperative, aided if necessary by a sea anchor.

**4b.182-1 Procedure for demonstrating control and stability on the water (FAA policies which apply to sec. 4b.182).**

(a) In order to check water stability, taxiing tests should be made in a crosswind determined in accordance with section 4b.181.

(b) Porpoising tendencies should be investigated and reported for extreme loading conditions.

(c) The ability to maneuver up to and while on the step should be investigated and the results reported.

(d) Compliance with the spray requirements may be substantiated while taxiing, taking off, and landing during other tests in the type certification program.

(e) If water rudders are provided, their effectiveness should be checked.

(f) Water taxiing ability should be investigated by actually taxiing the seaplane with appropriate use of power.

(19 F. R. 4461, July 20, 1954, effective Sept. 1, 1954.)

**4b.182-2 Control and stability on the water with reverse thrust (FAA policies which apply to sec. 4b.182).** The policies outlined in section 4b.402-1 (a), (d), (f), and (h) will apply.

(20 F. R. 2278, Apr. 8, 1955, effective Apr. 30, 1955.)

## Miscellaneous Flight Requirements

**4b.190 Flutter and vibration.**

(a) All parts of the airplane shall be demonstrated in flight to be free from flutter and excessive vibration under all speed and power conditions appropriate to the operation of the

airplane up to at least the minimum value permitted for  $V_D$  in section 4b.210 (b) (5). The maximum speeds so demonstrated shall be used in establishing the operating limitations of the airplane in accordance with section 4b.711.

(b) There shall be no buffeting condition in normal flight severe enough to interfere with the control of the airplane to cause excessive fatigue to the crew, or to cause structural damage.<sup>3</sup> (See also sec. 4b.308.)

<sup>3</sup> It is not the intent of this requirement to discourage such stall warning buffeting as does not contradict these provisions.

4b.190-1 *Determination of flutter and vibration qualities during dive (FAA policies which apply to sec. 4b.190).*

(a) *Observation for tendencies.* The airplane should be observed for flutter and vibration tendencies during other tests in the type certification program. In case the design speed is limited at altitude by Mach number, the dive should be conducted at a combination of pressure altitude and equivalent airspeed to permit attaining the desired maximum Mach number and dynamic pressure simultaneously. Stability and control qualities should be noted during the dive.

(b) *Configuration.* This test should be conducted in the configurations that follow:

- (1) *Maximum takeoff weight.*
  - C. G. position—most aft.
  - Wing flaps—retracted and takeoff position.
  - Landing gear—retracted.
  - Engines—power as desired.
  - Cooling controls—optional.
  - Pneumatic boots—inoperative.
- (2) *Maximum landing weight.*
  - C. G. position—most rearward.
  - Wing flaps—approach and landing positions.
  - Landing gear—extended.
  - Engines—power as desired.
  - Cooling controls—optional.
  - Pneumatic boots—inoperative.

(c) *Test procedure and required data.* The speed of the airplane should be slowly increased, from a steady flight high speed condition, until the maximum calibrated design dive speed for maximum takeoff weight is attained. The power and trim may be adjusted during the

dive. The dive should be entered at a sufficiently high altitude to insure safe recovery. In case the design speed is limited at altitude by Mach number, the airplane should be dived at constant Mach number (maximum design or highest desired by the applicant—but in no case less than that specified in section 4b.210 (b) (5)) until the maximum equivalent design dive speed is attained. The test should be repeated at maximum landing weight with flaps and gear extended diving to the maximum design flap speed or speeds. *CAUTION:* Throughout these tests any control displacements should be executed gently.

(1) The following data should be recorded for each test:

- Pressure altitude.
- Ambient air temperature.
- Indicated air speed.
- Machmeter reading (if applicable).
- Engines, r. p. m. and manifold pressure.
- Wing flap position.
- Landing gear position.
- Weight.
- C. G. position.

(19 F. R. 4461, July 20, 1954, effective Sept. 1, 1954.)

#### **[4b.191 High-speed characteristics.**

**[(a) Speed increase and recovery characteristics.**

**[(1) Operating conditions or characteristics likely to cause inadvertent speed increases, including upsets in pitch and roll, shall be simulated with the airplane trimmed at any likely cruise speed up to  $V_{MO}/M_{MO}$ . Allowing for pilot reaction time after effective inherent or artificial speed warning occurs (see sec. 4b.603(k)), it shall be demonstrated that the airplane can be recovered to a normal attitude and its speed reduced to  $V_{MO}/M_{MO}$  without requiring exceptional strength or skill on the part of the pilot, without exceeding  $V_D/M_D$ ,  $V_{DF}/M_{DF}$ , or the structural limitations, and without producing buffeting which would cause structural damage.**

**[NOTE: Examples of operating conditions or characteristics likely to cause speed increases are: gust upsets, inadvertent control movements, low stick force gradient in relation to control friction, passenger movement, leveling off from climb, and descent from Mach to airspeed limit altitudes.**



[(2) At all speeds up to  $V_{DF}/M_{DF}$ , there shall be no control reversal. Any reversal of elevator control force or tendency of the airplane to pitch, roll, or yaw, shall be mild and readily controllable using normal piloting technique.

[(b) *Maximum speed for stability characteristics,  $V_{FC}/M_{FC}$ .*  $V_{FC}/M_{FC}$  shall be the maximum speed at which the requirements of sections 4b.132(e), 4b.155(a), 4b.156, 4b.157(a),

4b.157(b), and 4b.158 are required to be met with flaps and landing gear retracted. It shall not be less than a speed halfway between  $V_{MO}/M_{MO}$  and  $V_{DF}/M_{DF}$ , except that in the altitude range where Mach number is the limiting factor,  $M_{FC}$  need not exceed the Mach number at which effective speed warning occurs.]

[(Amendment 4b-12, published 27 F. R. 2986, Mar. 30, 1962, effective May 3, 1962.)]

## Subpart C—Structure

### General

**4b.200 Loads.** Strength requirements of this subpart are specified in terms of limit and ultimate loads. Unless otherwise stated, the specified loads shall be considered as limit loads. In determining compliance with these requirements the following shall be applicable:

(a) The factor of safety shall be 1.5 unless otherwise specified.

(b) Unless otherwise provided, the specified air, ground, and water loads shall be placed in equilibrium with inertia forces, considering all items of mass in the airplane.

(c) All loads shall be distributed in a manner closely approximating or conservatively representing actual conditions.

(d) If deflections under load significantly change the distribution of external or internal loads, the redistribution shall be taken into account.

#### **4b.201 Strength and deformation.**

(a) The structure shall be capable of supporting limit loads without suffering detrimental permanent deformations.

(b) At all loads up to limit loads the deformation shall be such as not to interfere with safe operation of the airplane.

(c) The structure shall be capable of supporting ultimate loads without failure. It shall support the load for at least 3 seconds, unless proof of strength is demonstrated by dynamic tests simulating actual conditions of load application.

(d) Where structural flexibility is such that any rate of load application likely to occur in the operating conditions might produce transient stresses appreciably higher than those corre-

sponding with static loads, the effects of such rate of application shall be considered.

#### **4b.202 Proof of structure.**

(a) Proof of compliance of the structure with the strength and deformation requirements of section 4b.201 shall be made for all critical loading conditions.

(b) Proof of compliance by means of structural analysis shall be acceptable only when the structure conforms to types for which experience has shown such methods to be reliable. In all other cases substantiating tests shall be required.

(c) In all cases certain portions of the structure shall be tested as specified in section 4b.300.

(d) Proof of compliance of the structure with the fatigue evaluation requirements of section 4b.270 shall be made.

### Flight Loads

**4b.210 General.** Flight load requirements shall be complied with at critical altitudes within the range selected by the applicant at all weights from the design minimum weight to the maximum weight appropriate to each particular flight condition, with any practicable distribution of disposable load within prescribed operating limitations stated in the Airplane Flight Manual. (See sec. 4b.740.) Compressibility effects shall be taken into account at all speeds.

(a) *Flight load factor.* The flight load factors specified in this subpart shall represent the component of acceleration in terms of the gravitational constant. The flight load factor shall be assumed to act normal to the longitudinal axis of the airplane, shall be equal in magnitude, and shall be opposite in direction to

the airplane inertia load factor at the center of gravity.

(b) *Design air speeds.* The design air speeds shall be equivalent air speeds (EAS) and shall be chosen by the applicant, except that they shall not be less than the speeds defined in subparagraphs (1) through (5) of this paragraph. Where estimated values of the speeds  $V_{S_0}$  and  $V_{S_1}$  are used, such estimates shall be conservative.

[(1) *Design flap speeds,  $V_F$ .* The design flap speed for each flap position established in accordance with section 4b.323 (a) shall be sufficiently greater than the operating speed recommended for the corresponding stage of flight (including balked landings) to allow for probable variations in control of airspeed and for transition from one flap position to another.  $V_F$  shall be not less than:

[(i) 1.6  $V_{S_1}$  with flaps in takeoff position at maximum takeoff weight;

[(ii) 1.8  $V_{S_1}$  with flaps in approach position at maximum landing weight; and

[(iii) 1.8  $V_{S_0}$  with flaps in landing position at maximum landing weight.

[Where an automatic flap positioning or load limiting device is employed, it shall be permissible to use the speeds and corresponding flap positions programmed or permitted by the device. (See sec. 4b.323(c).)]

(2) *Design maneuvering speed,  $V_A$ .* The design maneuvering speed,  $V_A$ , shall be equal to  $V_{S_1} \sqrt{n}$  where  $n$  is the limit positive maneuvering load factor at  $V_C$  (see sec. 4b.211(a)) and  $V_{S_1}$  is the stalling speed with flaps retracted. Both  $V_A$  and  $V_S$  shall be evaluated at the design weight and altitude under consideration.  $V_A$  need not be greater than  $V_C$  or the speed at which the positive  $C_{N_{max}}$  curve intersects the positive maneuver load factor line, whichever is the lesser. (See fig. 4b-2.)

(3) *Design speed for maximum gust intensity,  $V_B$ .*  $V_B$  shall be either the speed determined by the intersection of the line representing the maximum positive lift  $C_{N_{max}}$  and the line representing the rough air gust velocity on the gust  $V$ - $n$  diagram or  $(\sqrt{ng}) V_{S_1}$ , whichever is the lesser; where  $n_r$  is the positive airplane gust load factor due to gust at speed  $V_C$

in accordance with section 4b.211 (b) (2) at the particular weight under consideration and  $V_{S_1}$  is the stalling speed with flaps retracted at the particular weight under consideration.  $V_B$  need not be greater than  $V_C$ .

(4) *Design cruising speed,  $V_C$ .* The minimum design cruising speed  $V_C$  shall be sufficiently greater than  $V_B$  to provide for inadvertent speed increases likely to occur as a result of severe atmospheric turbulence. In the absence of a rational investigation substantiating the use of other values,  $V_C$  shall not be less than  $V_B + 50$  (m. p. h.), except that it need not exceed the maximum speed in level flight at maximum continuous power for the corresponding altitude. At altitudes where  $V_D$  is limited by Mach number, it shall be acceptable to limit  $V_C$  to a Mach number selected by the applicant. [(See sec. 4b.711.)]

[(5) *Design dive speed,  $V_D$ .* The design dive speed chosen by the applicant shall be used in determining the maximum operating limit speed for the airplane in accordance with section 4b.711.]

(c) *Design fuel and oil loads.* The disposable load combinations shall include all fuel and oil loads in the range from zero fuel and oil to the maximum fuel and oil load selected by the applicant. It shall be permissible for the applicant to select a structural reserve fuel condition not exceeding 45 minutes of fuel under operating conditions defined in section 4b.437 (c). If a structural reserve fuel condition is selected, it shall be used as the minimum fuel weight condition for showing compliance with the flight load requirements as prescribed in this subpart, in which case, the provisions of subparagraphs (1) through (3) of this paragraph shall apply.

(1) The structure shall be designed for a condition of zero fuel and oil in the wing at limit loads corresponding with:

(i) A maneuver load factor of +2.25, and

(ii) Gust intensities equal to 85 percent of the values prescribed in section 4b.211 (b).

(2) Fatigue evaluation of the structure shall take into account any increase in operating stresses resulting from the design condition of subparagraph (1) of this paragraph (see sec. 4b.270).

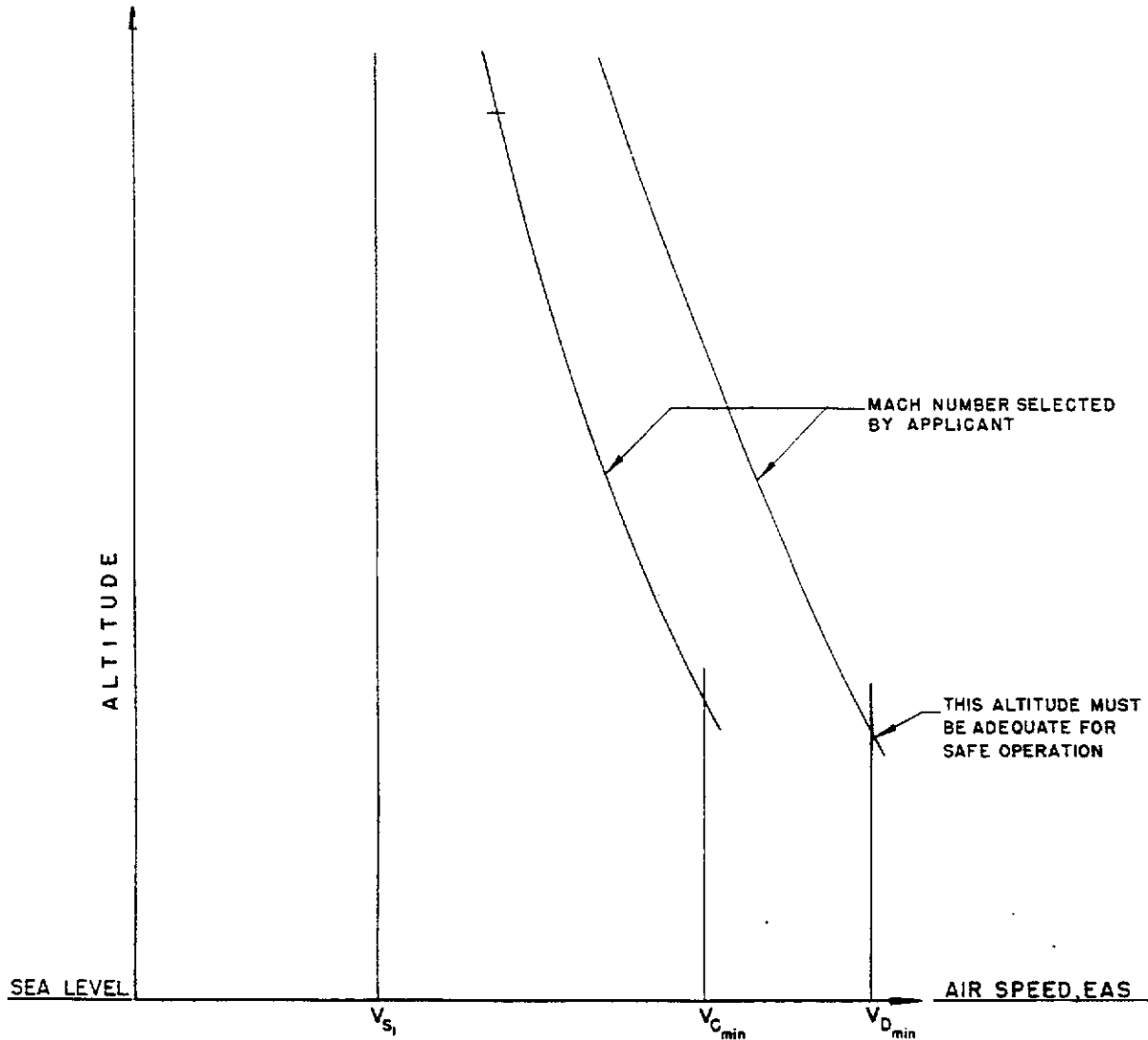

Figure 4b-1.—Minimum design airspeeds vs. altitude.

(3) The flutter, deformation, and vibration requirements shall also be met with zero fuel (see sec. 4b.308).

[(Amendment 4b-12, published 27 F. R. 2986, Mar. 30, 1962, effective May 3, 1962.)]

4b.211 *Flight envelopes.* The strength requirements shall be met at all combinations of air speed and load factor on and within the boundaries of the  $V$ - $n$  diagrams of figures 4b-2 and 4b-3 which represent the maneuvering and gust envelopes. These envelopes shall also be used in determining the airplane struc-

tural operating limitations as specified in section 4b.710.

(a) *Maneuvering load factors.* (See fig. 4b-2.) The airplane shall be assumed to be subjected to symmetrical maneuvers resulting in the limit load factors prescribed in subparagraphs (1) and (2) of this paragraph, except where limited by maximum (static) lift coefficients. Pitching velocities appropriate to the corresponding pull-up and steady turn maneuvers shall be taken into account. Lower values of maneuvering load factor shall be acceptable only if it is shown that the airplane

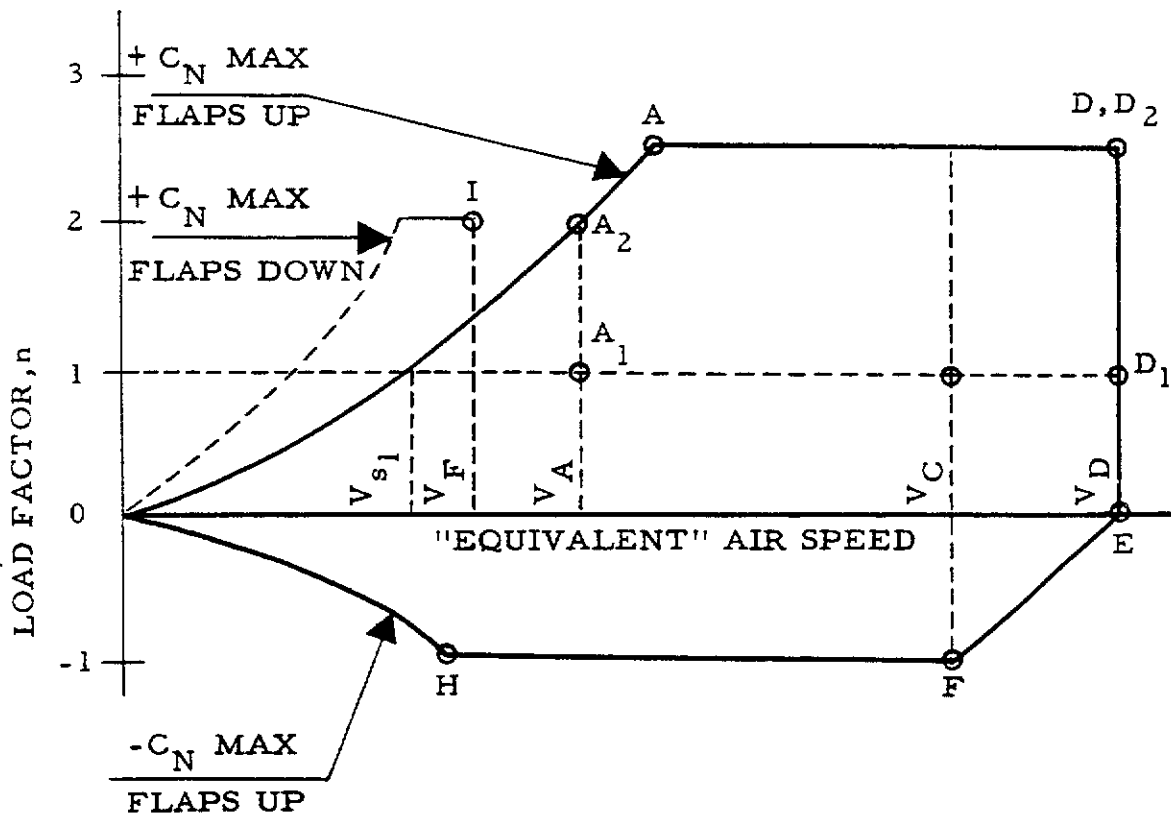

Figure 4b-2. —Maneuvering envelope.

embodies features of design which make it impossible to exceed such values in flight.

(1) The positive maneuvering load factor  $n$  for any flight speed up to  $V_D$  shall be selected by the applicant, except that it shall not be less than 2.5.

(2) The negative maneuvering load factor shall have a minimum value of  $-1.0$  at all speeds up to  $V_C$ , and it shall vary linearly with speed from the value at  $V_C$  to zero at  $V_D$ .

(b) *Gust load factors.* The airplane shall be assumed to be subjected to symmetrical vertical gusts while in level flight. The resulting limit load factors shall correspond with the conditions prescribed in subparagraphs (1) through (5) of this paragraph. The shape of the gust shall be assumed to be:

$$U = \frac{U_{de}}{2} \left( 1 - \cos \frac{2\pi s}{25C} \right);$$

where:

- $s$  = distance penetrated into gust (ft.);
- $C$  = mean geometric chord of wing (ft.);

$U_{de}$  = derived gust velocity referred to in subparagraphs (1) through (3) of this paragraph (fps).

(1) Positive (up) and negative (down) rough air gusts of 66 fps at the speed  $V_B$  shall be considered at altitudes between sea level and 20,000 feet. At altitudes above 20,000 feet, it shall be acceptable to reduce the gust velocity linearly from 66 fps at 20,000 feet to 38 fps at 50,000 feet.

(2) Positive and negative gusts of 50 fps at the speed  $V_C$  shall be considered at altitudes between sea level and 20,000 feet. At altitudes above 20,000 feet, it shall be acceptable to reduce the gust velocity linearly from 50 fps at 20,000 feet to 25 fps at 50,000 feet.

(3) Positive and negative gusts of 25 fps at the speed  $V_D$  shall be considered at altitudes between sea level and 20,000 feet. At altitudes above 20,000 feet, it shall be acceptable to reduce the gust velocity linearly from 25 fps at 20,000 feet to 12.5 fps at 50,000 feet.

(4) Gust load factors shall be assumed to vary linearly between the specified conditions

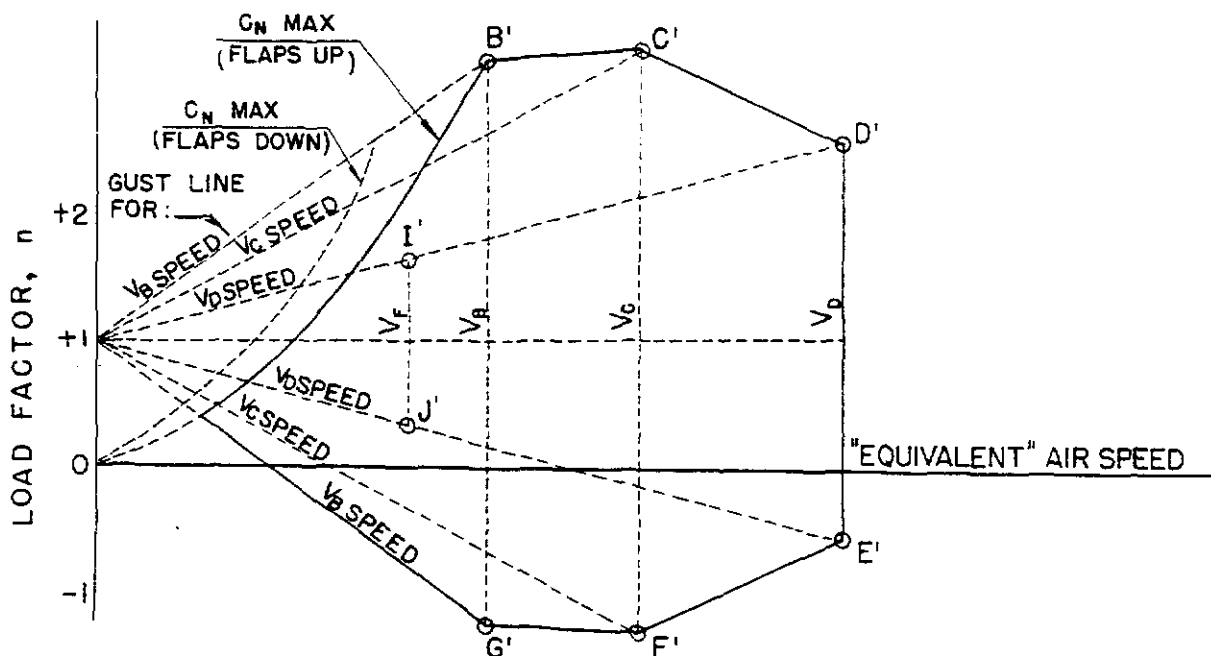

Figure 4b-3.—Gust envelope.

B' through G', as shown on the gust envelope of figure 4b-3.

(5) In the absence of a more rational analysis, the gust load factors shall be computed in accordance with the following formula:

$$n = 1 + \frac{K_z U_{de} V \alpha}{498 (W/S)}$$

where:

$$K_z = \frac{.88 \mu_g}{5.3 + \mu_g} = \text{gust alleviation factor};$$

$$\mu_g = \frac{2(W/S)}{p C a g} = \text{airplane mass ratio};$$

$U_{de}$  = derived gust velocities referred to in subparagraphs (1) through (3) of this paragraph (fps);

$p$  = density of air (slugs/cu.ft.);

$W/S$  = wing loading (psf);

$\bar{C}$  = mean geometric chord (ft.);

$g$  = acceleration due to gravity (ft/sec.<sup>2</sup>);

$V$  = airplane equivalent speed (knots);

$\alpha$  = slope of the airplane normal force coefficient curve  $C_{NA}$  per radian if the gust loads are applied to the wings and horizontal tail surfaces simultaneously by a rational method. It shall be acceptable to use the wing lift curve slope  $C_L$  per

radian when the gust load is applied to the wings only and the horizontal tail gust loads are treated as a separate condition.

#### 4b.212 Effect of high lift devices.

[(a) When flaps are intended for use during takeoff, approach, or landing, the airplane shall be assumed to be subjected to symmetrical maneuvers and gusts within the range determined by the following conditions, at the design flap speeds established for these stages of flight in accordance with section 4b.210(b)(1) and with the flaps in the corresponding positions:]

(1) Maneuvering to a positive limit load factor of 2.0,

(2) Positive and negative 25 fps derived gusts acting normal to the flight path in level flight.

(b) When flaps or similar high lift devices are intended for use in en route conditions (e. g., as speed brakes) the airplane shall be assumed to be subjected to symmetrical maneuvers and gusts, with flaps in the appropriate position at speeds up to the [flap design speed chosen for this condition] resulting in limit load factors, within the range determined by the following conditions:

(1) Maneuvering to a positive limit load factor of 2.5,

(2) Positive and negative derived gusts as prescribed in section 4b.211 (b) acting normal to the flight path in level flight.

[(c) The airplane shall be designed for the conditions prescribed in paragraph (a) of this section, except that the airplane load factor need not exceed 1.0, taking into account the following effects as separate conditions:

[(1) Propeller slipstream corresponding with maximum continuous power at the design flat speeds  $V_F$ , and with takeoff power at not less than 1.4 times the stalling speed for the particular flap position and associated maximum weight; and

[(2) A head-on gust of 25 feet per second velocity (EAS).]

[(Amendment 4b-12, published 27 F. R. 2986, Mar. 30, 1962, effective May 3, 1962.)]

#### 4b.213 Symmetrical flight conditions.

(a) *Procedure of analysis.* In the analysis of symmetrical flight conditions at least those specified in paragraphs (b), (c), and (d) of this section shall be considered. The following procedure of analysis shall be applicable:

(1) A sufficient number of points on the maneuvering and gust envelopes shall be investigated to insure that the maximum load for each part of the airplane structure is obtained. It shall be acceptable to use a conservative combined envelope for this purpose.

(2) All significant forces acting on the airplane shall be placed in equilibrium in a rational or a conservative manner. The linear inertia forces shall be considered in equilibrium with wing and horizontal tail surface loads, while the angular (pitching) inertia forces shall be considered in equilibrium with wing and fuselage aerodynamic moments and horizontal tail surface loads.

(3) Where sudden displacement of a control is specified, the assumed rate of displacement need not exceed that which actually could be applied by the pilot.

(4) In determining elevator angles and chordwise load distribution in the maneuvering conditions of paragraphs (b) and (c) of this section in turns and pullups, account shall be taken of the effect of corresponding pitching velocities.

(b) *Maneuvering balanced conditions.* The maneuvering conditions A through I on the maneuvering envelope (fig. 4b-2) shall be investigated, assuming the airplane to be in equilibrium with zero pitching acceleration.

(c) *Maneuvering pitching conditions.* The following conditions involving pitching acceleration shall be investigated (see fig. 4b-2):

(1) *Maximum elevator displacement at speed  $V_A$ .* The airplane shall be assumed to be flying in steady level flight (point  $A_1$  on fig. 4b-2) and the pitching control suddenly moved to obtain extreme positive pitching (nose up) except as limited by pilot effort in accordance with section 4b.220(a).

(2) *Checked maneuver at speeds between  $V_A$  and  $V_D$ .* The airplane shall be assumed to be subjected to a checked maneuver from steady level flight (points  $A_1$  to  $D_1$  on fig. 4b-2) and from the positive load factor (points  $A_2$  to  $D_2$  on fig. 4b-2) as follows:

(i) A positive pitching acceleration (nose up), equal to at least the following value, shall be assumed to be attained concurrently with the airplane load factor of unity (points  $A_1$  to  $D_1$  on fig. 4b-2) unless it is shown that lesser values could not be exceeded:

$$\frac{39}{V} n(n-1.5) \text{ (radians/sec.}^2\text{)}$$

where  $n$  is the positive load factor (see section 4b.211(a)(1)), at the speed under consideration, and  $V$  is the airplane equivalent speed, knots.

(ii) A negative pitching acceleration (nose down) equal to at least the following value shall be assumed to be attained concurrently with the airplane positive maneuvering load factor (points  $A_2$  to  $D_2$  on fig. 4b-2) unless it is shown that lesser values could not be exceeded:

$$-\frac{26}{V} n(n-1.5) \text{ (radians/sec.}^2\text{)}$$

where  $n$  is the positive load factor (see sec. 4b.211(a)(1)), at the speed under consideration, and  $V$  is the airplane equivalent speed, knots.

(3) *Specified control displacement.* In lieu of subparagraph (2) of this paragraph, a checked maneuver based on a rational pitching control motion vs. time profile may be estab-

lished such that the design limit load factor as defined in section 4b.211(a)(1) will not be exceeded. The airplane response shall result in pitching accelerations not less than those specified in subparagraph (2) unless it is shown that lesser values cannot be exceeded.

(d) *Gust conditions.* The gust conditions  $B'$  through  $J'$  on figure 4b-3 shall be investigated. The following provisions shall apply:

(1) The air load increment due to a specified gust shall be added to the initial balancing tail load corresponding with steady level flight.

(2) It shall be acceptable to include the alleviating effect of wing down-wash and of the airplane's motion in response to the gust in computing the tail gust load increment.

(3) In lieu of a rational investigation of the airplane response it shall be acceptable to apply the gust factor  $K_g$  (see sec. 4b.211 (b)) to the specified gust intensity for the horizontal tail.

4b.214 *Rolling conditions.* The airplane shall be designed for rolling loads resulting from the conditions specified in paragraphs (a) and (b) of this section. Unbalanced aerodynamic moments about the center of gravity shall be reacted in a rational or a conservative manner considering the principal masses furnishing the reacting inertia forces.

(a) *Maneuvering.* The following conditions, aileron deflection, and speeds, except as the deflections may be limited by pilot effort (see sec. 4b.220 (a)), shall be considered in combination with an airplane load factor of zero and of two-thirds of the positive maneuvering factor used in the design of the airplane. In determining the required aileron deflections, the torsional flexibility of the wing shall be taken into account in accordance with section 4b.200 (d).

(1) Conditions corresponding with steady rolling velocity shall be investigated. In addition, conditions corresponding with maximum angular acceleration shall be investigated for airplanes having engines or other weight concentrations outboard of the fuselage. For the angular acceleration conditions, it shall be acceptable to assume zero rolling velocity in the absence of a rational time history investigation of the maneuver.

(2) At speed  $V_A$  a sudden deflection of the aileron to the stop shall be assumed.

(3) At speed  $V_C$  the aileron deflection shall be that required to produce a rate of roll not less than that obtained in condition (2) of this paragraph.

(4) At speed  $V_D$  the aileron deflection shall be that required to produce a rate of roll not less than one-third of that in condition (2) of this paragraph.

(b) *Unsymmetrical gusts.* The condition of unsymmetrical gusts shall be considered by modifying the symmetrical flight conditions  $B'$  or  $C'$  of figure 4b-3, whichever produces the greater load factor. It shall be assumed that 100 percent of the wing air load acts on one side of the airplane, and 80 percent acts on the other side.

4b.215 *Yawing conditions.* The airplane shall be designed for loads resulting from the conditions specified in paragraphs (a) and (b) of this section. Unbalanced aerodynamic moments about the center of gravity shall be reacted in a rational or a conservative manner considering the principal masses furnishing the reacting inertia forces.

(a) *Maneuvering.* At all speeds from  $V_{MC}$  to  $V_A$  the following maneuvers shall be considered. In computing the tail loads it shall be acceptable to assume the yawing velocity to be zero.

(1) With the airplane in unaccelerated flight at zero yaw, it shall be assumed that the rudder control is suddenly displaced to the maximum deflection as limited by the control stops or by a 300 lb. rudder pedal force, whichever is critical.

(2) With the rudder deflected as specified in subparagraph (1) of this paragraph it shall be assumed that the airplane yaws to the resulting sideslip angle.

(3) With the airplane yawed to the static sideslip angle corresponding with the rudder deflection specified in subparagraph (1) of this paragraph, it shall be assumed that the rudder is returned to neutral.

(b) *Lateral gusts.* The airplane shall be assumed to encounter derived gusts normal to the plane of symmetry while in unaccelerated flight. The derived gusts and airplane speeds

corresponding with conditions *B'* through *J'* on figure 4b-3 as determined by sections 4b.211 (b) and 4b.212 (a) (2) or section 4b.212 (b) (2) shall be investigated. The shape of the gust shall be as specified in section 4b.211 (b). In the absence of a rational investigation of the airplane's response to a gust, it shall be acceptable to compute the gust loading on the vertical tail surfaces by the following formula:

$$L_t = \frac{K_{g_t} U_{de} V_{a_t} S_t}{498}$$

where:

$L_t$  = vertical tail load (lbs.);

$K_{g_t} = \frac{.88 \mu_{g_t}}{5.3 + \mu_{g_t}}$  = gust alleviation factor;

$\mu_{g_t} = \frac{2W}{\rho \bar{C}_t g a_t S_t} \left( \frac{K}{l_t} \right)^2$  = lateral mass ratio;

$U_{de}$  = derived gust velocity (fps);

$\rho$  = air density (slugs/cu. ft.);

$W$  = airplane weight (lbs.);

$S_t$  = area of vertical tail (ft.<sup>2</sup>);

$\bar{C}_t$  = mean geometric chord of vertical surface (ft.);

$a_t$  = lift curve slope of vertical tail (per radian);

$K$  = radius of gyration in yaw (ft.);

$l_t$  = distance from airplane c. g. to lift center of vertical surface (ft.);

$g$  = acceleration due to gravity (ft./sec.<sup>2</sup>);

$V$  = airplane equivalent speed (knots).

#### 4b.216 Supplementary flight conditions.

(a) *Engine torque effects.* Engine mounts and their supporting structures shall be designed for engine torque effects combined with basic flight conditions as described in subparagraphs (1) through (3) of this paragraph. The limit torque shall be obtained by multiplying the mean torque by a factor of 1.33 in the case of engines having 5 or more cylinders. For 4, 3, and 2-cylinder engines, the factors shall be 2, 3, and 4, respectively. For turbine propeller installations the limit torque shall be obtained by multiplying the mean torque by a factor of 1.25.

(1) The limit torque corresponding with take-off power and propeller speed shall act simultaneously with 75 percent of the limit loads from flight condition *A* (see fig. 4b-2).

(2) The limit torque corresponding with maximum continuous power and propeller speed shall act simultaneously with the limit loads from flight condition *A* (see fig. 4b-2).

(3) For turbine propeller installations, in addition to the conditions specified in subparagraphs (1) and (2) of this paragraph, the limit torque corresponding with takeoff power and propeller speed multiplied by a factor of 1.6 shall be considered to act simultaneously with lg level flight loads.

(4) For turbine engine installations, the limit torque load imposed by sudden engine stoppage due to malfunction or structural failure (e. g., compressor jam-up) shall be considered in the design of the engine mounts and supporting structure.

(b) *Side load on engine mount.* The limit load factor in a lateral direction for this condition shall be equal to the maximum obtained in the yawing conditions, but shall not be less than either 1.33 or one-third the limit load factor for flight condition *A* (see fig. 4b-2). Engine mounts and their supporting structure shall be designed for this condition which may be assumed independent of other flight conditions.

(c) *Pressurized cabin loads.* When pressurized compartments are provided for the occupants of the airplane, the following requirements shall be met. (See sec. 4b.373.)

(1) The airplane structure shall have sufficient strength to withstand the flight loads combined with pressure differential loads from zero up to the maximum relief valve setting. Account shall be taken of the external pressure distribution in flight. Stress concentration and fatigue effects shall be accounted for in the design of pressure cabins (see sec. 4b.270).

(2) If landings are to be permitted with the cabin pressurized, landing loads shall be combined with pressure differential loads from zero up to the maximum to be permitted during landing.

(3) The airplane structure shall have sufficient strength to withstand the pressure differential loads corresponding with the maximum relief valve setting multiplied by a factor of 1.33. It shall be acceptable to omit all other loads in this case.



[(4) Where a pressurized cabin is separated into two or more compartments by partitions, bulkheads, or floors, the structure supporting the prescribed flight and ground loads and other structure the failure of which could interfere with continued safe flight and landing of the airplane, shall be designed to withstand the effects of sudden release of pressure in any compartment through an opening resulting from the failure or penetration of an external door, window, or windshield panel, or from structural fatigue or penetration of the fuselage in such compartment unless it is shown that the probability of failure or penetration is extremely remote. In determining the probability of failure or penetration and probable size of openings, it shall be acceptable to take into account fail-safe features of the design, provided possible improper operation of closure devices and inadvertent door openings are also taken into account. It shall be acceptable to take into account pressure relief provided by intercompartment venting. It can be assumed that parts of the airplane, other than the structure specified in this paragraph, may be damaged, in which case reasonable design precautions shall be taken to minimize the probability of parts becoming detached which may injure occupants while in their seats.

[NOTE: The aforementioned precautions might include, for example, designing internal doors so that they will remain attached to supporting structure even though forced open by differential pressure.]

[(d) *Unsymmetrical loads due to engine failure.* The airplane shall be designed for the unsymmetrical loads resulting from the failure of the critical engine. Turbopropeller airplanes shall be designed for the conditions prescribed in subparagraphs (1) through (4) of this paragraph in combination with a single malfunction of the propeller drag limiting system (see sec. 4b.408), taking into account the probable pilot corrective action on the flight controls.

[(1) At all speeds between  $V_{MC}$  and  $V_D$ , the loads resulting from engine power failure due to fuel flow interruption shall be considered as limit loads.

[(2) At all speeds between  $V_{MC}$  and  $V_C$ , the loads resulting from the disconnection of the engine compressor from the turbine or

from loss of the turbine blades shall be considered as ultimate loads.

[(3) The time history of the thrust decay and drag build-up occurring as a result of the prescribed engine failures shall be substantiated by test or other data applicable to the particular engine-propeller combination.

[(4) The timing and magnitude of the probable pilot corrective action shall be conservatively estimated, considering the characteristics of the particular engine-propeller-airplane combination.

[NOTE: It may be assumed that pilot corrective action will be initiated at the time maximum yawing velocity is attained, but not earlier than two seconds after the engine failure. The magnitude of the corrective action may be based on the control forces specified in section 4b.220(a)(1), except that lower forces may be assumed where it is shown by analysis or test that such forces will be sufficient to control the yaw and roll resulting from the prescribed engine failure conditions.]

(e) *Gyroscopic loads.* The structure supporting the engines shall be designed for gyroscopic loads associated with the conditions specified in sections 4b.213 through 4b.215 with the engines operating at maximum continuous rpm.

[(Amendment 4b-12, published 27 F. R. 2986, Mar. 30, 1962, effective May 3, 1962.)]

4b.217 *Speed control devices.* When speed control devices (e.g., spoilers, drag flaps, etc.) are incorporated for use in en route conditions, the following conditions shall apply:

(a) The airplane shall be designed for the symmetrical maneuvers and gusts prescribed in section 4b.211 and the yawing maneuvers and lateral gusts in section 4b.215 with the device extended at all speeds up to the placard device extended speed.

(b) When the speed control device incorporates automatic operation or load limiting features, the airplane shall be designed for the maneuver and gust conditions prescribed in paragraph (a) of this section, at the speeds and corresponding device positions which the mechanism permits.

## Control Surface and System Loads

4b.220 *Control surface loads; general.* The control surfaces shall be designed for the limit loads resulting from the flight conditions

prescribed in sections 4b.213 through 4b.215 and the ground gust conditions prescribed in section 4b.226, taking into account the provisions of paragraphs (a) through (e) of this section.

(a) *Effect of pilot effort.*

(1) In the control surface flight loading conditions the air loads on the movable surfaces and the corresponding deflections need not exceed those which could be obtained in flight by employing the maximum pilot control forces specified in figure 4b-5, except that two-thirds of the maximum values specified for the aileron and elevator shall be acceptable when control surface hinge moments are based on reliable data. In applying this criterion, proper consideration shall be given to the effects of servo mechanisms, tabs, and automatic pilot systems in assisting the pilot.

(b) *Effect of trim tabs.* The effect of trim tabs on the main control surface design conditions need be taken into account only in cases where the surface loads are limited by pilot effort in accordance with the provisions of paragraph (a) of this section. In such cases the trim tabs shall be considered to be deflected in the direction which would assist the pilot, and the deflection shall be as follows:

(1) For elevator trim tabs the deflections shall be those required to trim the airplane at any point within the positive portion of the  $V-n$  diagram (fig. 4b-2), except as limited by the stops.

(2) For aileron and rudder trim tabs the deflections shall be those required to trim the airplane in the critical unsymmetrical power and loading conditions, with appropriate allowance for rigging tolerances.

(c) *Unsymmetrical loads.* Horizontal tail surfaces and the supporting structure shall be designed for unsymmetrical loads arising from yawing and slipstream effects in combination with the prescribed flight conditions.

NOTE: In the absence of more rational data, the following assumptions may be made for airplanes which are conventional in regard to location of propellers, wings, tail surfaces, and fuselage shape: 100 percent of the maximum loading from the symmetrical flight conditions acting on the surface on one side of the plane of symmetry and 80 percent of this loading on the other side. Where the design is not conventional (e. g., where the horizontal tail surfaces have appreciable

dihedral or are supported by the vertical tail surfaces), the surfaces and supporting structures may be designed for combined vertical and horizontal surface loads resulting from the prescribed maneuvers.

(d) *Outboard fins.*

(1) When outboard fins are carried on the horizontal tail surface, the tail surfaces shall be designed for the maximum horizontal surface load in combination with the corresponding loads induced on the vertical surfaces by end plate effects. Such induced effects need not be combined with other vertical surface loads.

(2) To provide for unsymmetrical loading when outboard fins extend above and below the horizontal surface, the critical vertical surface loading (load per unit area) as determined by the provisions of this section shall also be applied as follows:

(i) 100 percent to the area of the vertical surfaces above (or below) the horizontal surface, and

(ii) 80 percent to the area below (or above) the horizontal surface.

(e) *Loads parallel to hinge line.* Control surfaces and supporting hinge brackets shall be designed for inertia loads acting parallel to the hinge line.

NOTE: In lieu of a more rational analysis the inertia loads may be assumed to be equal to  $KW$ , where:

$K=24$  for vertical surfaces.

$K=12$  for horizontal surfaces.

$W$ = weight of the movable surfaces.

**[4b.221 *Wing flaps.* Wing flaps and their supporting structure and operating mechanism shall be designed for the critical loads resulting from the conditions prescribed in section 4b.212, taking into account the loads occurring during transition from one flap position and airspeed to another.]**

**[(Amendment 4b-12, published 27 F. R. 2986, Mar. 30, 1962, effective May 3, 1962.)]**

**4b.222 *Tabs.* The following shall apply to tabs and their installations:**

(a) *Trimming tabs.* Trimming tabs shall be designed to withstand loads arising from all likely combinations of tab setting, primary control position, and airplane speed, obtainable without exceeding the flight load conditions prescribed for the airplane as a whole, when the effect of the tab is being opposed by pilot effort loads up to those specified in section 4b.220 (a).

(b) *Balancing tabs.* Balancing tabs shall be designed for deflections consistent with the primary control surface loading conditions.

(c) *Servo tabs.* Servo tabs shall be designed for all deflections consistent with the primary control surface loading conditions achievable within the pilot maneuvering effort (see sec. 4b.220 (a)) with due regard to possible opposition from the trim tabs.

4b.223 *Special devices.* The loading for special devices employing aerodynamic surfaces, such as slots and spoilers, shall be based on test data.

4b.224 *Primary flight control systems.* Elevator, aileron, and rudder control systems and their supporting structures shall be designed for loads corresponding with 125 percent of the computed hinge moments of the movable control surface in the conditions prescribed in section 4b.220, subject to the following provisions:

(a) The system limit loads, except the loads resulting from ground gusts (sec. 4b.226), need not exceed those which can be produced by the pilot or pilots and by automatic devices operating the controls. Acceptable maximum and minimum pilot loads for elevator, aileron, and rudder controls are shown in figure 4b-5. These pilot loads shall be assumed to act at the appropriate control grips or pads in a manner simulating flight conditions and to be reacted at the attachment of the control system to the control surface horn.

(b) The loads shall in any case be sufficient to provide a rugged system for service use, including considerations of jamming, ground gusts, taxiing tail to wind, control inertia, and friction.

4b.225 *Dual primary flight control systems.*

(a) When dual controls are provided, the system shall be designed for the pilots operating in opposition, using individual pilot loads equal to 75 percent of those obtained in accordance with section 4b.224, except that the individual pilot loads shall not be less than the minimum loads specified in figure 4b-5.

(b) The control system shall be designed for the pilots acting in conjunction, using individual pilot loads equal to 75 percent of those obtained in accordance with section 4b.224.

4b.226 *Ground gust conditions.* The following conditions intended to simulate the loadings on control surfaces due to ground gusts and when taxiing downwind shall be investigated:

(a) The control system between the stops nearest the surfaces and the cockpit controls shall be designed for loads corresponding with the limit hinge moments  $H$  of paragraph (b) of this section, except that these loads need not exceed those corresponding with the maxima of figure 4b-5 for each pilot alone, or with 75 percent of these maxima for each pilot when the pilots act in conjunction.

(b) The control system stops nearest the surfaces, the control system locks, and the portions of the systems, if any, between such stops and locks and the control surface horns shall be designed for limit hinge moments  $H$  obtained from the following formula:

$$H = KcSq,$$

where:

$H$  = limit hinge moment (ft. lbs.),

$c$  = mean chord of the control surface aft of the hinge line (ft.),

$S$  = area of the control surface aft of the hinge line (sq. ft.),

$q$  = dynamic pressure (p. s. f.) based on a design speed not less than  $10\sqrt{W/S} + 10$  (m. p. h.), except that the design speed need not exceed 60 m. p. h.,

$K$  = factor as specified in figure 4b-4.

4b.227 *Secondary control systems.* Secondary controls, such as wheel brake, spoiler, and tab controls, shall be designed for the loads based on the maximum which a pilot is likely to apply to the control in question. The values of figure 4b-6 are considered acceptable.

Surface	$K$	Position of controls
(a) Aileron.....	0.75	Control column locked or lashed in mid-position.
(b) Aileron.....	* ± 0.50	Ailerons at full throw.
(c) Elevator.....	* ± 0.75	(c) Elevator full down.
(d) Elevator.....		(d) Elevator full up.
(e) Rudder.....	0.75	(e) Rudder in neutral.
(f) Rudder.....		(f) Rudder at full throw.

\*A positive value of  $K$  indicates a moment tending to depress the surface, while a negative value of  $K$  indicates a moment tending to raise the surface.

Figure 4b-4.—Limit hinge moment factor for ground gusts.

[Limit pilot loads (one pilot)]

Control	Maximum load	Minimum load
Aileron:		
Stick.....	100 lbs.....	40 lbs.
Wheel*.....	80 <i>D</i> in. lbs.**.....	40 <i>D</i> in. lbs.
Elevator:		
Stick.....	250 lbs.....	100 lbs.
Wheel.....	300 lbs.....	100 lbs.
Rudder.....	300 lbs.....	130 lbs.

\*The critical portions of the aileron control system shall be designed for a single tangential force having a limit value equal to 1.25 times the couple force determined from these criteria.

\*\**D* = wheel diameter.

Figure 4b-5.—Pilot control force limits (primary controls).

Control	Limit pilot loads
Miscellaneous: *Crank wheel or lever.	$\frac{1+R}{3} \times 50$ lbs., but not less than 50 lbs. nor more than 150 lbs. ( <i>R</i> = radius). (Applicable to any angle within 20° of plane of control.)
Twist.....	133 in. lbs.
Push-pull.....	To be chosen by applicant.

\*Limited to flap, tab, stabilizer, spoiler, and landing gear operating controls.

Figure 4b-6.—Pilot control force limits (secondary controls).

## Ground Loads

**4b.230 General.** The limit loads obtained in the conditions specified in sections 4b.231 through 4b.236 shall be considered as external forces applied to the airplane structure and shall be placed in equilibrium by linear and angular inertia forces in a rational or conservative manner. In applying the specified conditions the provisions of paragraph (a) of this section shall be complied with. In addition, for the landing conditions of sections 4b.231 through 4b.234 the airplane shall be assumed to be subjected to forces and descent velocities prescribed in paragraph (b) of this section. (The basic landing gear dimensional data are given in figure 4b-7.)

(a) **Center of gravity positions.** The critical center of gravity positions within the certification limits shall be selected so that the maximum design loads in each of the landing

gear elements are obtained in the landing and the ground handling conditions.

(b) **Load factors, descent velocities, and design weights for landing conditions.**

(1) In the landing conditions the limit vertical inertia load factors at the center of gravity of the airplane shall be chosen by the applicant, except that they shall not be less than the values which would be obtained in the attitude and subject to the drag loads associated with the particular landing condition, and with the following limit descent velocities and weights:

(i) 10 f. p. s. at the design landing weight, and

(ii) 6 f. p. s. at the design takeoff weight.

(2) It shall be acceptable to assume a wing lift not exceeding the airplane weight to exist throughout the landing impact and to act through the center of gravity of the airplane.

(3) The provisions of subparagraphs (1) and (2) of this paragraph shall be predicated on conventional arrangements of main and nose gears, or main and tail gears, and on normal operating techniques. It shall be acceptable to modify the prescribed descent velocities if it is shown that the airplane embodies features of design which make it impossible to develop these velocities. (See sec. 4b.332 (a) for requirements on energy absorption tests which determine the minimum limit inertia load factors corresponding with the required limit descent velocities.)

### 4b.231 Level landing conditions.

(a) **General.** In the level attitude the airplane shall be assumed to contact the ground at forward velocity components parallel to the ground ranging from  $V_{L1}$  to  $1.25 V_{L2}$  and shall be assumed to be subjected to the load factors prescribed in section 4b.230 (b) (1) where  $V_{L1}$  is equal to  $V_{s0}$  (TAS) at the appropriate landing weight and in standard sea level conditions and where  $V_{L2}$  is equal to  $V_{s0}$  (TAS) at the appropriate landing weight and altitudes in a hot day temperature of 41° F. above standard. When approval of landings downwind exceeding 10 mph is sought, the effect of increased contact speeds shall be investigated. The following three combinations of vertical and drag com-

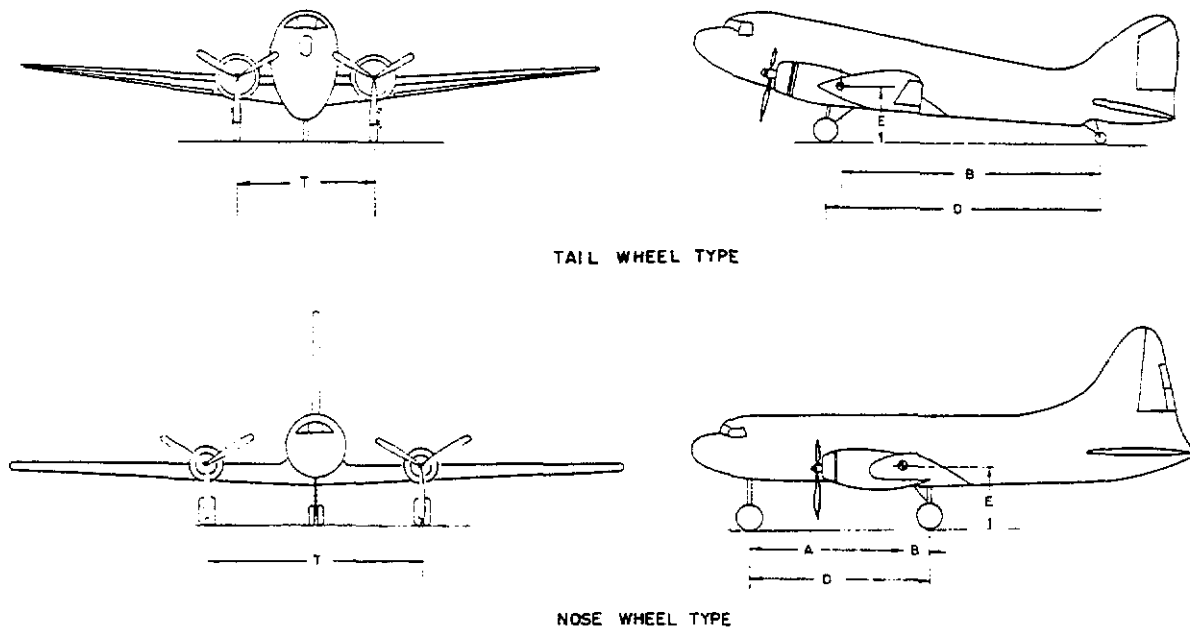

Figure 4b-7.—Basic landing gear dimension data.

ponents shall be considered acting at the axle center line:

(1) *Condition of maximum wheel spin-up load.* Drag components simulating the forces required to accelerate the wheel rolling assembly up to the specified ground speed shall be combined with the vertical ground reactions existing at the instant of peak drag loads. It shall be acceptable to establish the coefficient of friction between the tires and the ground by considering the effects of skidding velocity and tire pressure, except that it need not be greater than 0.8. It shall be acceptable to apply this condition only to the landing gear, directly affected attaching structure, and large mass items; i. e., external fuel tanks, nacelles, etc.

(2) *Condition of maximum wheel vertical load.* An aft acting drag component not less than 25 percent of the maximum vertical ground reaction shall be combined with the maximum ground reaction of section 4b.230 (b).

(3) *Condition of maximum spring-back load.* Forward-acting horizontal loads resulting from a rapid reduction of the spin-up drag loads shall be combined with the vertical ground reactions at the instant of the peak forward load. It shall be acceptable to apply this condition only to the landing gear, directly

affected attaching structure, and large mass items; i. e., external fuel tanks, nacelles, etc.

(b) *Level landing; tail-wheel type.* The airplane horizontal reference line shall be assumed to be horizontal. The conditions specified in paragraph (a) of this section shall be investigated. (See fig. 4b-8.)

(c) *Level landing; nose-wheel type.* The following airplane attitudes shall be considered: (See fig. 4b-8.)

(1) Main wheels shall be assumed to contact the ground with the nose wheel just clear of the ground. The conditions specified in paragraph (a) of this section shall be investigated.

(2) Nose and main wheels shall be assumed to contact the ground simultaneously. Conditions in this attitude need not be investigated if this attitude cannot reasonably be attained at the specified descent and forward velocities. The conditions specified in paragraph (a) of this section shall be investigated, except that in conditions (a) (1) and (a) (3) it shall be acceptable to investigate the nose and main gear separately neglecting the pitching moments due to wheel spin-up and spring-back loads, while in condition (a) (2) the pitching moment shall be assumed to be resisted by the nose gear.

**4b.232 Tail-down landing conditions.** In the conditions of paragraphs (a) and (b) of this section the airplane shall be assumed to contact the ground at forward velocity components parallel to the ground, ranging from  $V_{L_1}$  to  $V_{L_2}$ , where  $V_{L_1}$  and  $V_{L_2}$  are as indicated in section 4b.231 (a). The load factors prescribed in section 4b.230 (b) (1) shall apply. The combination of vertical and drag components specified in sections 4b.231 (a) (1) and 4b.231 (a) (3) shall be considered acting at the main wheel axle centerline.

(a) *Tail-wheel type.* The main and tail wheels shall be assumed to contact the ground simultaneously. (See fig. 4b-9.) Two conditions of ground reaction on the tail wheel shall be assumed to act in the following directions:

- (1) Vertical,
- (2) Up and aft through the axle at  $45^\circ$  to the ground line.

(b) *Nose-wheel type.* The airplane shall be assumed to be at an attitude corresponding with either the stalling angle or the maximum angle permitting clearance with the ground by all parts of the airplane other than the main wheels, whichever is the lesser. (See fig. 4b-9.)

**4b.233 One-wheel landing condition.** The main landing gear on one side of the airplane centerline shall be assumed to contact the ground in the level attitude. (See fig. 4b-10.) The ground reactions on this side shall be the same as those obtained in section 4b.231 (a) (2). The unbalanced external loads shall be reacted by inertia of the airplane in a rational or conservative manner.

**4b.234 Lateral drift landing condition.**

(a) The airplane shall be assumed to be in the level attitude with only the main wheels contacting the ground. (See fig. 4b-11.)

(b) Side loads of 0.8 of the vertical reaction (on one side) acting inward and 0.6 of the vertical reaction (on the other side) acting outward shall be combined with one-half of the maximum vertical ground reactions obtained in the level landing conditions. These loads shall be assumed to be applied at the ground contact point and to be resisted by the inertia of the airplane. It shall be acceptable to assume the drag loads to be zero.

**4b.234a Rebound landing condition.** The landing gear and its supporting structure shall be investigated for the loads occurring during rebound of the airplane from the landing surface. With the landing gear fully extended and not in contact with the ground, a load factor of 20.0 shall act on the unsprung weights of the landing gear. This load factor shall act in the direction of motion of the unsprung weights as they reach their limiting positions in extending with relation to the sprung portions of the landing gear.

**4b.235 Ground handling conditions.** The landing gear and airplane structure shall be investigated for the conditions of this section with the airplane at the design takeoff weight, unless otherwise prescribed. No wing lift shall be considered. It shall be acceptable to assume the shock absorbers and tires to be deflected to their static position. In the conditions of [paragraphs (b) (1) and (2), and (e)(3),] it shall be acceptable to use a drag reaction lower than prescribed therein if it is substantiated that an effective drag force of 0.8 times the vertical reaction cannot be attained under any likely loading condition.

(a) *Takeoff run.* The landing gear and the airplane structure shall be assumed to be subjected to loads not less than those encountered under conditions described in section 4b.172.

(b) *Braked roll.*

(1) *Tail-wheel type.* The airplane shall be assumed to be in the level attitude with all load on the main wheels. The limit vertical load factor shall be 1.2 for the airplane at the design landing weight, and 1.0 for the airplane at the design takeoff weight. A drag reaction equal to the vertical reaction multiplied by a coefficient of friction of 0.8 shall be combined with the vertical ground reaction and applied at the ground contact point. (See fig. 4b-12.)

(2) *Nose-wheel type.* The limit vertical load factor shall be 1.2 for the airplane at the design landing weight, and 1.0 for the airplane at the design takeoff weight. A drag reaction equal to the vertical reaction multiplied by a coefficient friction of 0.8 shall be combined with the vertical reaction and applied at the ground contact point of each wheel having brakes. The following two air-

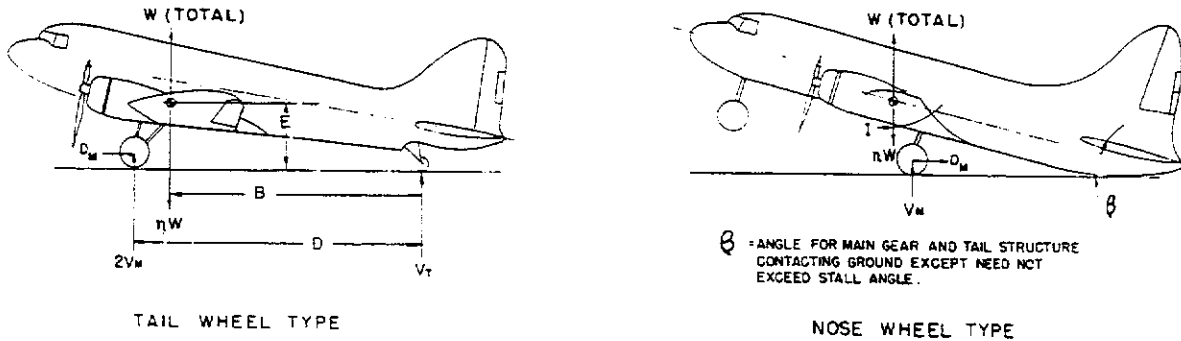
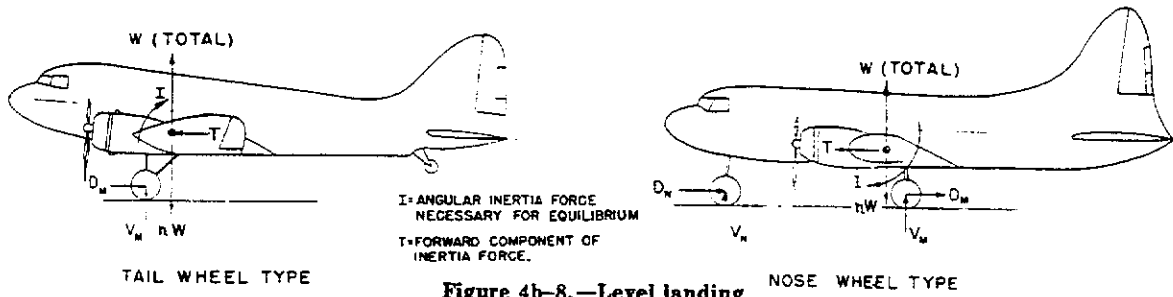

plane attitudes shall be considered: (See fig. 4b-12.)

(i) The airplane shall be assumed to be in level attitude with all wheels contacting the ground and the loads distributed between the main and nose gear. Zero pitching acceleration shall be assumed.

(ii) The airplane shall be assumed to be in the level attitude with only the main gear contacting the ground and the pitching moment resisted by angular acceleration.

(c) *Turning.* The airplane in the static position shall be assumed to execute a steady turn by nose gear steering or by application of differential power such that the limit load factors applied at the center of gravity are 1.0 vertically and 0.5 laterally. (See fig. 4b-13.) The side ground reaction of each wheel shall be 0.5 of the vertical reaction.

(d) *Pivoting.* The airplane shall be assumed to pivot about one side of the main gear, the brakes on that side being locked. The limit vertical load factor shall be 1.0 and the coefficient of friction 0.8. The airplane shall be assumed to be in static equilibrium, the loads being applied at the ground contact points. (See fig. 4b-14.)

(e) *Nose-wheel yawing.*

(1) A vertical load factor of 1.0 at the airplane center of gravity and a side component at the nose wheel ground contact equal to 0.8 of the vertical ground reaction at that point shall be assumed.

(2) [It shall be acceptable to apply the conditions of this subparagraph to the design of only the nose gear, its attaching structure, and the fuselage structure.] The airplane shall be assumed to be in static equilibrium with the loads resulting from the application of the brakes on one side of the main gear. The vertical load factor at the center of gravity shall be 1.0. The forward acting load at the airplane center of gravity shall be 0.8 times the vertical load on one main gear. The side and vertical loads at the ground contact point on the nose gear shall be those required for static equilibrium. The side load factor at the airplane center of gravity shall be assumed to be zero. Where this condition results in a nose gear side load in excess of 0.8 times the vertical nose gear load, it shall be acceptable to limit the design nose gear side load to 0.8 times the vertical load with the unbalanced yawing moments assumed to be resisted by aircraft inertia forces.

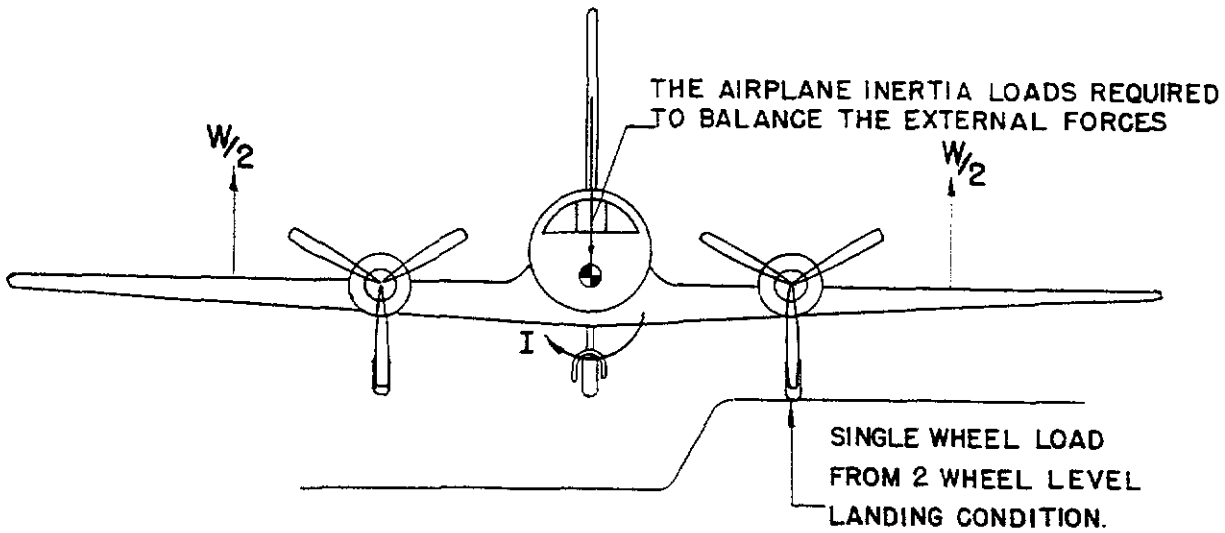

NOSE OR TAIL WHEEL TYPE

Figure 4b-10.—One wheel landing.

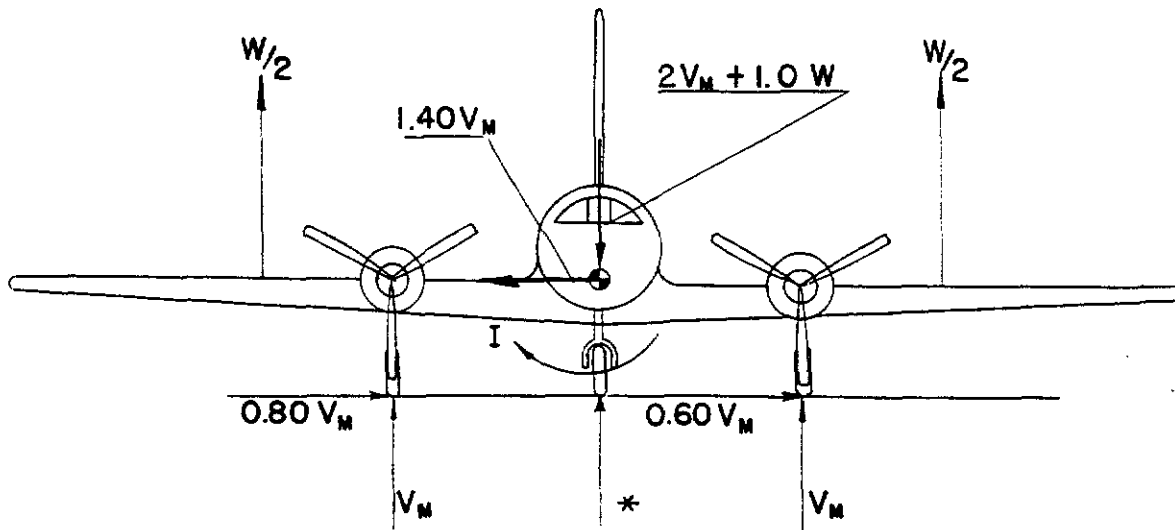

$V_M$  = ONE-HALF THE MAXIMUM VERTICAL GROUND REACTION OBTAINED AT EACH MAIN GEAR IN THE LEVEL LANDING CONDITIONS.

\* NOSE GEAR GROUND REACTION = 0

NOSE OR TAIL WHEEL TYPE AIRPLANE IN LEVEL ALTITUDE

Figure 4b-11.—Lateral drift landing.

[(3) This subparagraph shall apply to the landing gear and airplane structure. The loading conditions shall be those prescribed in subparagraph (2) of this paragraph, except that the forward acting load at the center of gravity

need not exceed the maximum drag reaction on one main gear determined in accordance with the introductory paragraph and paragraph (b)(2) of this section.]



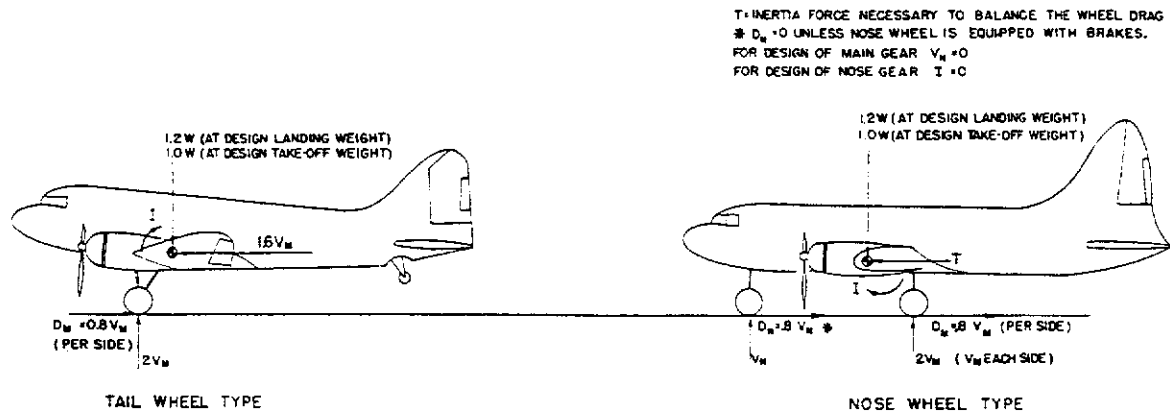

Figure 4b-12.—Braked roll.

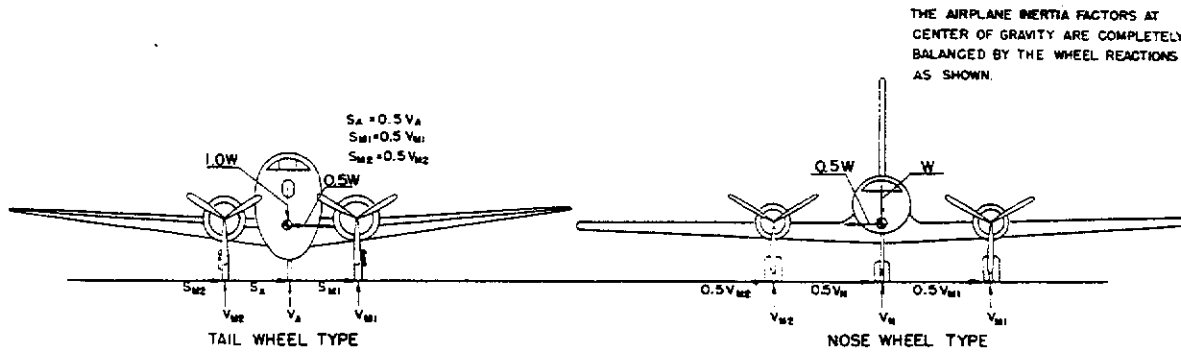

Figure 4b-13.—Ground turning.

(f) Tail-wheel yawing.

(1) A vertical ground reaction equal to the static load on the tail wheel in combination with a side component of equal magnitude shall be assumed.

(2) When a swivel is provided, the tail wheel shall be assumed to be swiveled 90° to the airplane longitudinal axis with the resultant load passing through the axle. When a lock, steering device, or shimmy damper is provided, the tail wheel shall also be assumed to be in the trailing position with the side load acting at the ground contact point.

(g) Reversed braking. The airplane shall be in a three point static ground attitude. Horizontal reactions parallel to the ground and directed forward shall be applied at the ground contact point of each wheel equipped with brakes. The limit loads shall be equal either to 0.55 times the vertical load at each wheel or to the load developed by 1.2 times the nominal maximum static brake torque, whichever is the lesser. For nose-wheel types, the

pitching moment shall be balanced by rotational inertia. For tail-wheel types, the resultant of the ground reactions shall pass through the center of gravity of the airplane.

(h) Towing loads. Towing loads shall be those specified in figure 4b-26, considering each condition separately. These loads shall be applied at the towing fittings and shall act parallel to the ground. A vertical load factor equal to 1.0 shall be considered acting at the center of gravity. The shock struts and tires shall be in their static positions. The towing load,  $F_{TOW}$ , shall be defined as equal to  $.3W_T$  for  $W_T$  less than 30,000 pounds, equal to  $\frac{6W_T + 450,000}{70}$  for  $W_T$  between 30,000 and

100,000 pounds and equal to  $.15W_T$  for  $W_T$  over 100,000 pounds, where  $W_T$  is the design maximum takeoff weight. For towing points not on the landing gear but located near the plane of symmetry of the airplane, the drag and side tow load components specified for the

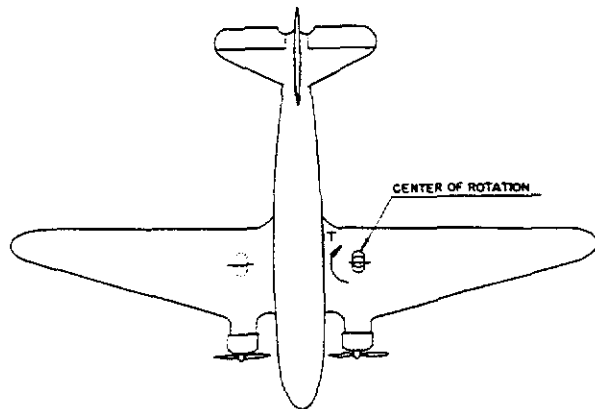

$V_n$  AND  $V_m$  ARE STATIC GROUND REACTIONS, FOR TAIL WHEEL TYPE THE AIRPLANE IS IN THE THREE POINT ATTITUDE. PIVOTING IS ASSUMED TO TAKE PLACE ABOUT ONE MAIN LANDING GEAR UNIT.

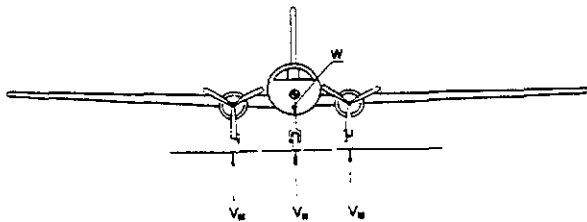

Figure 4b-14.—Pivoting, nose or tail wheel type.

auxiliary gear shall apply. For tow points located outboard of the main gear, the drag and side tow load components specified for the main gear shall apply. In cases where the specified angle of swivel cannot be obtained, the maximum obtainable angle shall be used.

[(Amendment 4b-12, published 27 F. R. 2986, Mar. 30, 1962, effective May 3, 1962.)]

**4b.236 Unsymmetrical loads on multiple-wheel units.**

(a) *General.* Multiple-wheel landing gear units shall be assumed to be subjected to the limit ground loads prescribed in this subpart in accordance with the provisions of paragraphs (b) and (c) of this section. A tandem strut gear arrangement shall be considered to be a multiple-wheel unit.

(b) *Distribution of limit loads to wheels; all tires inflated.* The distribution of the limit loads among the wheels of the landing gears shall be established for all landing, taxiing, and ground handling conditions, taking into account the effects of the factors enumer-

ated in subparagraphs (1) through (6) of this paragraph.

(1) Number of wheels and their physical arrangement. In the case of truck type landing gear units, the effects of any see-saw motion of the truck during the landing impact shall be considered in determining the maximum design loads for the fore and aft wheel pairs.

(2) Differentials in tire diameters resulting from a combination of manufacturing tolerances, tire growth, and tire wear. It shall be acceptable to assume a maximum tire-diameter differential equal to  $\frac{3}{8}$  of the worst combination of diameter variations which is obtained when taking into account manufacturing tolerances, tire growth, and tire wear.

(3) Unequal tire inflation pressure, assuming the maximum variation to be  $\pm 5$  percent of the nominal tire inflation pressure.

(4) A runway crown of zero and a runway crown having a convex upward shape which may be approximated by a slope of  $1\frac{1}{2}$  percent with the horizontal. Runway crown effects shall be considered with the nose gear unit on either slope of the crown.

(5) Airplane attitude.

(6) Structural deflections.

(c) *Deflated tires.* The effect of deflated tires on the structure shall be considered with respect to the loading conditions specified in subparagraphs (1), (2), and (3) of this paragraph taking into account the physical arrangement of the gear components. Consideration shall be given to the deflation of any one tire for all multiple wheel landing gear units and, in addition, to the deflation of any 2 critical tires for landing gear units employing 4 or more wheels per unit. The ground reactions shall be applied to the wheels with inflated tires, except that for multiple-wheel gear units incorporating more than one shock strut, it shall be permissible to use a rational distribution of the ground reactions between the deflated and inflated tires, taking into account the differences in shock strut extensions resulting from a deflated tire.

(1) *Landing conditions.* For one deflated tire and for 2 deflated tires, the applied load to each gear unit shall be assumed to be 60 percent and 50 percent, respectively, of the limit

load applied to each gear for each of the prescribed landing conditions except that, for the drift landing condition of section 4b.234, 100 percent of the vertical load shall be applied.

(2) *Taxiing and ground handling conditions.* For one deflated tire and for 2 deflated tires, the applied side and/or drag load factor at the center of gravity shall be the most critical value up to 50 percent and 40 percent, respectively, of the limit side and/or drag load factors corresponding with the most severe condition resulting from consideration of the prescribed taxiing and ground handling conditions except that, for the braked roll conditions of section 4b.235 (b) (1) and (2) (ii), the drag loads on each inflated tire shall not be less than those at each tire for the symmetrical load distribution with no deflated tires. For one and 2 deflated tires the vertical load factor at the center of gravity shall be 60 percent and 50 percent, respectively, of the factor with no deflated tires, except that it shall not be less than 1g. Pivoting need not be considered.

(3) *Towing conditions.* For one deflated tire and for 2 deflated tires, the towing load,  $F_{TOW}$ , shall be 60 percent and 50 percent, respectively, of the load prescribed.

NOTE: In determining the total load on a gear unit with respect to the provisions of paragraphs (b) and (c) of this section, the transverse shift in the load centroid, due to unsymmetrical load distribution on the wheels, is normally neglected.

### Water Loads

4b.250 *General.* The structure of hull and float type seaplanes shall be designed for water loads developed during takeoff and landing with the seaplane in any attitude likely to occur in normal operation at appropriate forward and sinking velocities under the most severe sea conditions likely to be encountered. Unless a more rational analysis of the water loads is performed, the requirements of sections 4b.251 through 4b.258 shall apply.

4b.250-1 *Water loads—alternate standards (FAA policies which apply to sec. 4b.250).* ANC-3 provides a level of safety equivalent to, and may be applied in lieu of, section 4b.250.

(17 F. R. 10102, Nov. 7, 1952, effective Oct. 31, 1952.)

4b.251 *Design weights and center of gravity positions.*

(a) *Design weights.* The water load requirements shall be complied with at all operating weights up to the design landing weight except that for the takeoff condition prescribed in section 4b.255 the design takeoff weight shall be used.

(b) *Center of gravity positions.* The critical center of gravity positions within the limits for which certification is sought shall be considered to obtain maximum design loads for each part of the seaplane structure.

4b.252 *Application of loads.*

(a) The seaplane as a whole shall be assumed to be subjected to the loads corresponding with the load factors specified in section 4b.253, except as otherwise prescribed. In applying the loads resulting from the load factors prescribed in section 4b.253, it shall be permissible to distribute the loads over the hull bottom in order to avoid excessive local shear loads and bending moments at the location of water load application, using pressures not less than those prescribed in section 4b.256 (b).

(b) For twin float seaplanes, each float shall be treated as an equivalent hull on a fictitious seaplane having a weight equal to one-half the weight of the twin float seaplane.

(c) Except in the takeoff condition of section 4b.255, the aerodynamic lift on the seaplane during the impact shall be assumed to be  $\frac{2}{3}$  of the weight of the seaplane.

4b.253 *Hull and main float load factors.* Water reaction load factors shall be computed as follows:

For the step landing case:

$$n_w = \frac{C_1 V_{s_0}^2}{\tan^{2/3} \beta_w^{1/3}}$$

For the bow and stern landing cases:

$$n_w = \frac{C_1 V_{s_0}^2}{\tan^{2/3} \beta W_{1.0}} \times \frac{K_1}{(1+r_z^2)^{2/3}}$$

where:

$n_w$  = water reaction load factor (water reaction divided by the seaplane weight);

$C_1$  = empirical seaplane operations factor equal to 0.009, except that this factor shall not be less than that

necessary to obtain the minimum value of step load factor of 2.33;  
 $V_{s_0}$ =seaplane stalling speed (mph) with landing flaps extended in the appropriate position and with no slip-stream effect;

$\beta$ =angle of dead rise at the longitudinal station at which the load factor is being determined (see fig. 4b-15a);

$W$ =seaplane design landing weight in pounds.

$K_1$ =empirical hull station weighing factor. (See fig. 4b-15b.) For a twin float seaplane, in recognition of the effect of flexibility of the attachment of the floats to the seaplane, it shall be acceptable to reduce the factor  $K_1$  at the bow and stern to 0.8 of the value shown in figure 4b-15b. This reduction shall not apply to the float design but only to the design of the carry-through and seaplane structure;

$r_x$ =ratio of distance, measured parallel to hull reference axis, from the center of gravity of the seaplane to the hull longitudinal station at which the load factor is being computed to the radius of gyration in pitch of the seaplane, the hull reference axis being a straight line, in the plane of symmetry, tangential to the keel at the main step.

#### 4b.254 *Hull and main float landing conditions.*

(a) *Symmetrical step landing.* The limit water reaction load factor shall be in accordance with section 4b.253. The resultant water load shall be applied at the keel through the center of gravity perpendicularly to the keel line.

(b) *Symmetrical bow landing.* The limit water reaction load factor shall be in accordance with section 4b.253. The resultant water load shall be applied at the keel  $\frac{1}{2}$  of the longitudinal distance from the bow to the step, and shall be directed perpendicularly to the keel line.

(c) *Symmetrical stern landing.* The limit water reaction load factor shall be in accordance with section 4b.253. The resultant water load shall be applied at the keel at a point 85 percent of the longitudinal distance from

the step to the stern post, and shall be directed perpendicularly to the keel line.

(d) *Unsymmetrical landing; hull type and single float seaplanes.* Unsymmetrical step, bow, and stern landing conditions shall be investigated. The loading for each condition shall consist of an upward component and a side component equal, respectively, to 0.75 and  $0.25 \tan \beta$  times the resultant load in the corresponding symmetrical landing condition. (See paragraphs (a), (b), and (c) of this section.) The point of application and direction of the upward component of the load shall be the same as that in the symmetrical condition, and the point of application of the side component shall be at the same longitudinal station as the upward component but directed inward perpendicularly to the plane of symmetry at a point midway between the keel and chine lines.

(e) *Unsymmetrical landing; twin float seaplanes.* The unsymmetrical loading shall consist of an upward load at the step of each float of 0.75 and a side load of  $0.25 \tan \beta$  at one float times the step landing load obtained in accordance with section 4b.253. The side load shall be directed inboard perpendicularly to the plane of symmetry midway between the keel and chine lines of the float at the same longitudinal station as the upward load.

4b.255 *Hull and main float takeoff condition.* The provisions of this section shall apply to the design of the wing and its attachment to the hull or main float. The aerodynamic wing lift shall be assumed to be zero. A downward inertia load shall be applied and shall correspond with the following load factor:

$$n = \frac{C_{T0} V_{s_1}^2}{\tan^{1/2} \beta W^{1/2}}$$

where:

$n$ =inertia load factor;

$C_{T0}$ =empirical seaplane operations factor equal to 0.003;

$V_{s_1}$ =seaplane stalling speed (mph) at the design takeoff weight with the flaps extended in the appropriate takeoff position;

$\beta$ =angle of dead rise at the main step (degrees);

$W$ =seaplane design takeoff weight in pounds.

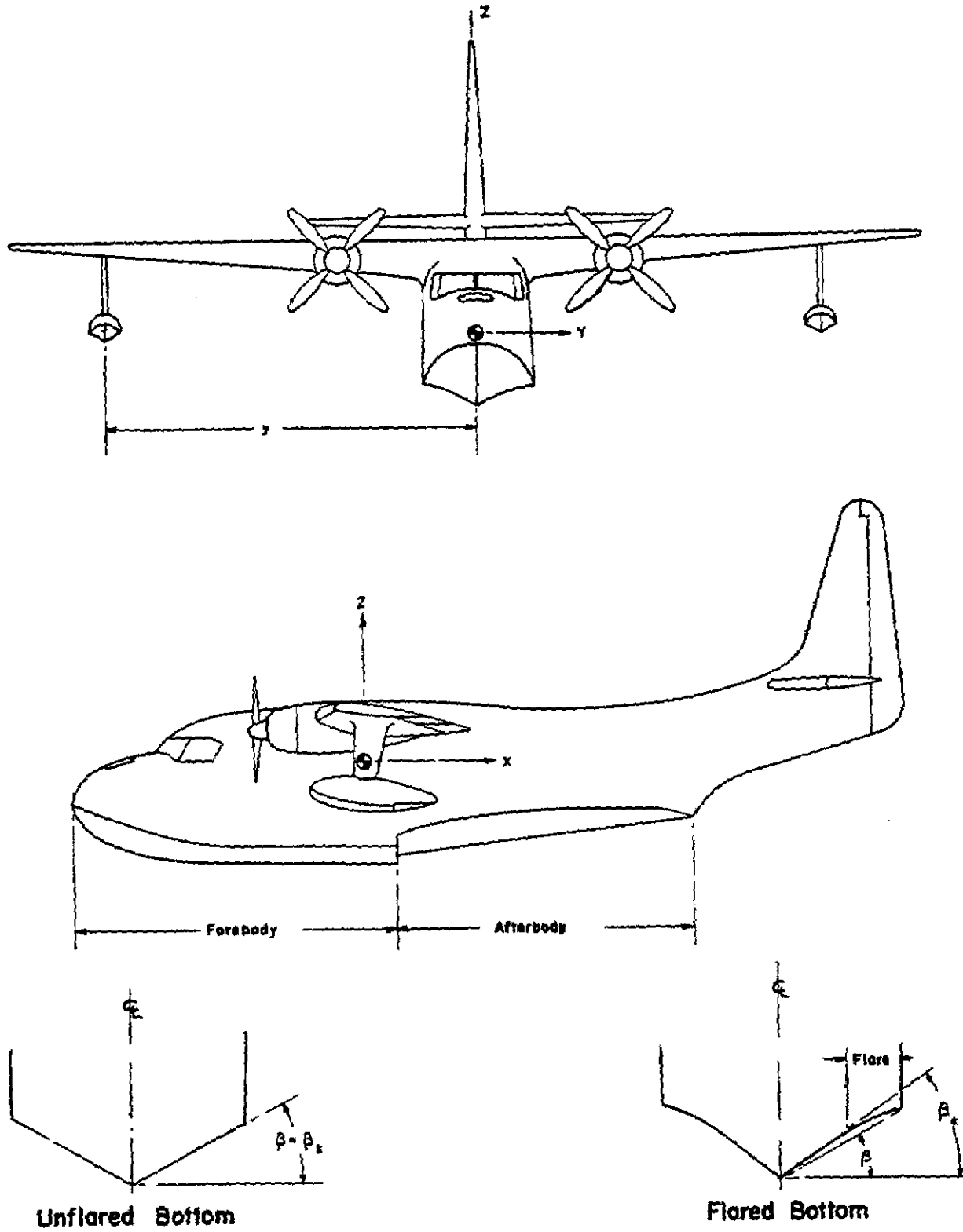

Figure 4b-15a.—Pictorial definition of angles, dimensions, and directions on a seaplane.

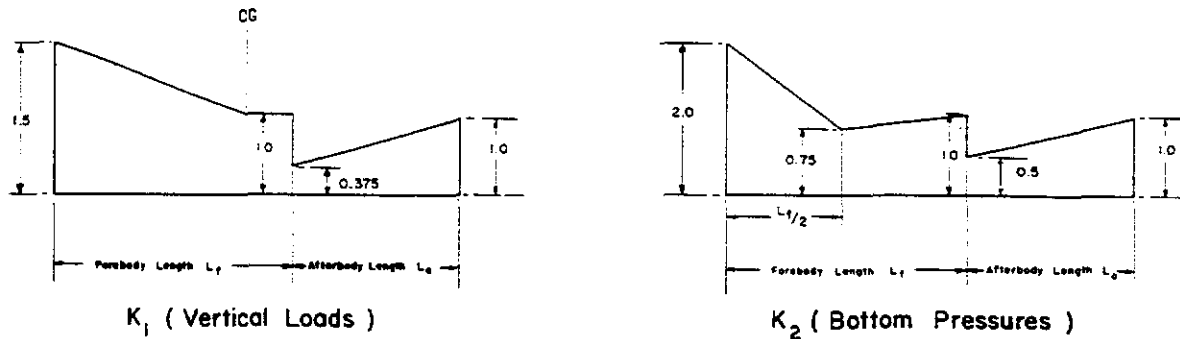

Figure 4b-15b.—Hull station weighing factor.

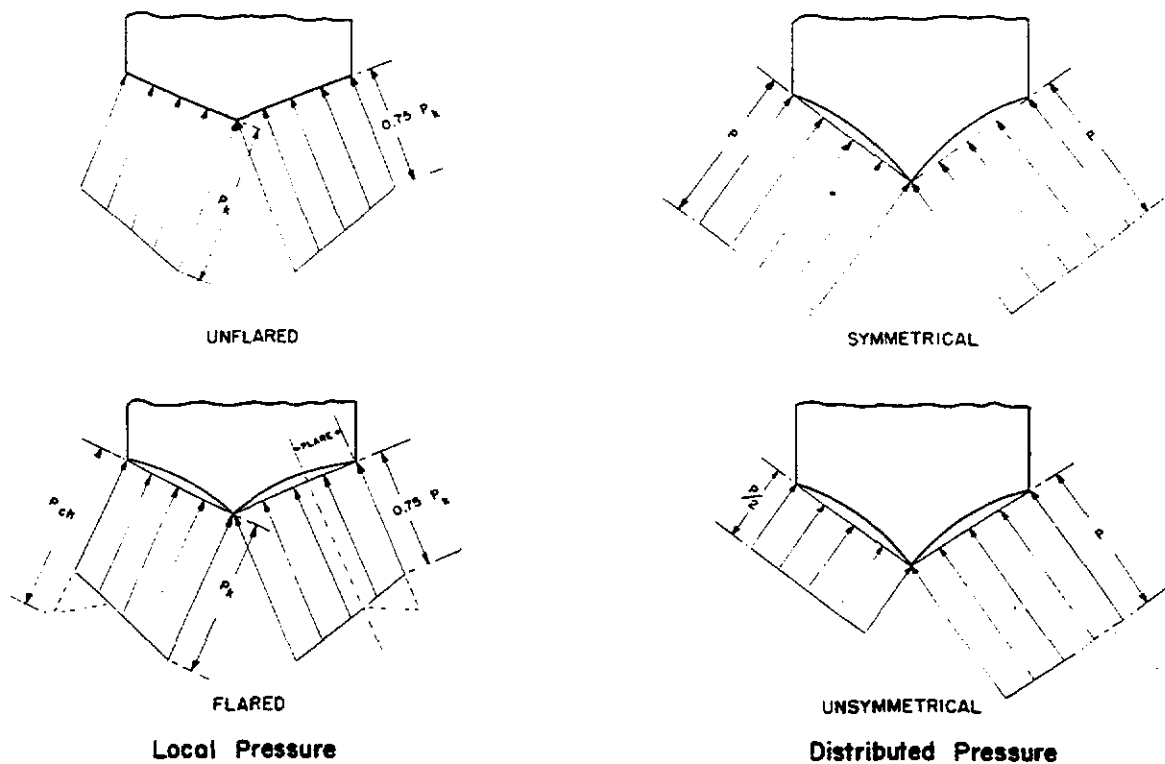

Figure 4b-15c.—Transverse pressure distributions.

4b.256 *Hull and main float bottom pressures.* The provisions of this section shall apply to the design of the hull and main float structure, including frames and bulkheads, stringers, and bottom plating. In the absence of more rational data, the pressures and distributions shall be as follows:

(a) *Local pressures.* The following pressure distributions are applicable for the design of the bottom plating and stringers and their attachments to the supporting structure. The area over which these pressures are applied shall be such as to simulate pressures occurring

during high localized impacts on the hull or float, and need not extend over an area which would induce critical stresses in the frames or in the overall structure:

(1) *Unflared bottom.* The pressure at the keel (psi) shall be computed as follows:

$$P_k = C_2 \frac{K_2 V_{st}^2}{\tan \beta_k};$$

where:

$P_k$  = pressure at the keel;

$C_2 = 0.0016$ ;

$K_2$  = hull station weighing factor (see fig. 4b-15b);

$V_{s_1}$  = seaplane stalling speed (mph) at the design takeoff weight with flaps extended in the appropriate takeoff position;

$\beta_k$  = angle of dead rise at keel (see fig. 4b-15a).

The pressure at the chine shall be  $0.75 P_k$ , and the pressures between the keel and chine shall vary linearly. (See fig. 4b-15c.)

(2) *Flared bottom.* The pressure distribution for a flared bottom shall be that for an unflared bottom prescribed in subparagraph (1) of this paragraph, except that the pressure at the chine shall be computed as follows:

$$P_{ch} = C_3 \frac{K_2 V_{s_1}^2}{\tan \beta};$$

where:

$P_{ch}$  = pressure at the chine;

$C_3 = 0.0012$ ;

$K_2$  = hull station weighing factor (see fig. 4b-15b);

$V_{s_1}$  = seaplane stalling speed (mph) at the design takeoff weight with flaps extended in the appropriate takeoff position;

$\beta$  = angle of dead rise at appropriate station.

The pressure at the beginning of the flare shall be the same as for an unflared bottom, and the pressure between the chine and the beginning of the flare shall vary linearly. (See fig. 4b-15c.)

(b) *Distributed pressures.* The following distributed pressures are applicable for the design of the frames, keel, and chine structure. These pressures shall be uniform and shall be applied simultaneously over the entire hull or main float bottom. The loads so obtained shall be carried into the sidewall structure of the hull proper, but need not be transmitted in a fore and aft direction as shear and bending loads.

(1) *Symmetrical.* The symmetrical pressures shall be computed as follows:

$$P = C_4 \frac{K_2 V_{s_0}^2}{\tan \beta};$$

where:

$P$  = pressure;

$C_4 = 0.078C_1$  (for  $C_1$  see sec. 4b.253);

$K_2$  = hull station weighing factor (see fig. 4b-15b);

$V_{s_0}$  = seaplane stalling speed (mph) with landing flaps extended in the appropriate position and with no slipstream effect;

$\beta$  = angle of dead rise at appropriate station.

(2) *Unsymmetrical.* The unsymmetrical pressure distribution shall consist of the pressures prescribed in subparagraph (1) of this paragraph on one side of the hull or main float centerline and one-half of that pressure on the other side of the hull or main float centerline. (See fig. 4b-15c.)

4b.257 *Auxiliary float loads.* Auxiliary floats, their attachments, and supporting structure shall be designed for the following conditions. In the cases specified in paragraphs (a), (b), (c), and (d) of this section it shall be acceptable to distribute the prescribed water loads over the float bottom to avoid excessive local loads, using bottom pressures not less than those prescribed in paragraph (f) of this section.

(a) *Step loading.* The resultant water load shall be applied in the plane of symmetry of the float at a point three-fourths of the distance from the bow to the step and shall be perpendicular to the keel. The resultant limit load shall be computed as follows, except that the value of  $L$  need not exceed three times the weight of the displaced water when the float is completely submerged:

$$L = \frac{C_5 V_{s_0}^2 W^{2/3}}{\tan^{2/3} \beta (1 + r_y^2)^{2/3}};$$

where:

$L$  = limit load

$C_5 = 0.004$ ;

$V_{s_0}$  = seaplane stalling speed (mph) with landing flaps extended in the appropriate position and with no slipstream effect;

$W$  = seaplane design landing weight in pounds;

$\beta$  = angle of dead rise at a station  $\frac{3}{4}$  of the distance from the bow to the step, but need not be less than 15 degrees;

$r_y$  = ratio of the lateral distance between the center of gravity and the plane of symmetry of the float to the radius of gyration in roll.

(b) *Bow loading.* The resultant limit load shall be applied in the plane of symmetry of the float at a point one-fourth of the distance from the bow to the step and shall be perpendicular to the tangent to the keel line at that point. The magnitude of the resultant load shall be that specified in paragraph (a) of this section.

(c) *Unsymmetrical step loading.* The resultant water load shall consist of a component equal to 0.75 times the load specified in paragraph (a) of this section and a side component equal to  $0.25 \tan \beta$  times the load specified in paragraph (a) of this section. The side load shall be applied perpendicularly to the plane of symmetry of the float at a point midway between the keel and the chine.

(d) *Unsymmetrical bow loading.* The resultant water load shall consist of a component equal to 0.75 times the load specified in paragraph (b) of this section and a side component equal to  $0.25 \tan \beta$  times the load specified in paragraph (b) of this section. The side load shall be applied perpendicularly to the plane of symmetry at a point midway between the keel and the chine.

(e) *Immersed float condition.* The resultant load shall be applied at the centroid of the cross section of the float at a point one-third of the distance from the bow to the step. The limit load components shall be as follows:

$$\text{vertical} = \rho g V$$

$$\text{aft} = C_x \frac{\rho}{2} V^{3/2} (KV_{s_0})^2$$

$$\text{side} = C_y \frac{\rho}{2} V^{3/2} (KV_{s_0})^2$$

where:

$\rho$  = mass density of water;

$V$  = volume of float;

$C_x$  = coefficient of drag force, equal to 0.10;

$C_y$  = coefficient of side force, equal to 0.08;

$K$  = 0.8, except that lower values shall be acceptable if it is shown that the floats are incapable of submerging at a speed of  $0.8 V_{s_0}$  in normal operations;

$V_{s_0}$  = seaplane stalling speed (mph) with landing flaps extended in the appropriate position and with no slipstream effect.

(f) *Float bottom pressures.* The float bottom pressures shall be established in accordance with section 4b.256 (a) and (b). The angle of dead rise to be used in determining the float bottom pressures shall be as defined in paragraph (a) of this section.

4b.258 *Seawing loads.* Seawing design loads shall be based on applicable test data.

### Emergency Landing Conditions

4b.260 *General.* The following requirements deal with emergency conditions of landing on land or water in which the safety of the occupants shall be considered, although it is accepted that parts of the airplane may be damaged.

(a) The structure shall be designed to give every reasonable probability that all of the occupants, if they make proper use of the seats, belts, and other provisions made in the design (see sec. 4b.358), will escape serious injury in the event of a minor crash landing (with wheels up if the airplane is equipped with retractable landing gear) in which the occupants experience the following ultimate inertia forces relative to the surrounding structure:

- (1) Upward... 2.0g (Downward... 4.5g)
- (2) Forward... 9.0g
- (3) Sideward... 1.5g

(b) The use of a lesser value of the downward inertia force specified in paragraph (a) of this section shall be acceptable if it is shown that the airplane structure can absorb the landing loads corresponding with the design landing weight and an ultimate descent velocity of 5 f. p. s. without exceeding the value chosen.

(c) The inertia forces specified in paragraph (a) of this section shall be applied to all items of mass which would be apt to injure the passengers or crew if such items became loose in the event of a minor crash landing, and the supporting structure shall be designed to restrain these items.

4b.261 *Structural ditching provisions.* (For structural strength considerations of ditching provisions see sec. 4b.361 (c).)

### Fatigue Evaluation

4b.270 [*Fatigue evaluation of flight structure.*] The strength, detail design, and



fabrication of those portions of the airplane's flight structure in which fatigue may be critical shall be evaluated in accordance with the provisions of either paragraph (a) or (b) of this section.

(a) *Fatigue strength.* The structure shall be shown by analysis and/or tests to be capable of withstanding the repeated loads of variable magnitude expected in service. The provisions of subparagraphs (1) through (3) of this paragraph shall apply.

(1) Evaluation of fatigue shall involve the following:

(i) Typical loading spectrum expected in service;

(ii) Identification of principal structural elements and detail design points, the fatigue failure of which could cause catastrophic failure of the aircraft; and

(iii) An analysis and/or repeated load tests of principal structural elements and detail design points identified in subdivision (ii) of this subparagraph.

NOTE: Usually tests of principal structural elements include major fittings, samples of joints, spar cap strips, skin units, and other representative sections of the flight structure.

(2) It shall be acceptable to utilize the service history of airplanes of similar structural design, taking due account of differences in operating conditions and procedures.

(3) When circumstances require substantiation of the pressure cabin by fatigue tests, the cabin or representative portions of it shall be cycle-pressure tested, utilizing the normal operating pressure together with the effects of external aerodynamic pressure combined with the flight loads. It shall be acceptable to represent the effects of flight loads by an increased cabin pressure, or to omit the flight loads if they are shown to have no significant effect upon fatigue.

(b) *Fail safe strength.* It shall be shown by analysis and/or tests that catastrophic failure or excessive structural deformation, which could adversely affect the flight characteristics of the airplane, are not probable after fatigue failure or obvious partial failure of a single principal structural element. After such failure, the remaining structure shall be capable

of withstanding static loads corresponding with the flight loading condition specified in subparagraphs (1) through (4) of this paragraph. These loads shall be multiplied by a factor of 1.15 unless the dynamic effects of failure under static load are otherwise taken into consideration. In the case of a pressure cabin, the normal operating pressures combined with the expected external aerodynamic pressures shall be applied simultaneously with the flight loading conditions specified in this paragraph.

(1) An ultimate maneuver load factor of 2.0 at  $V_C$ .

(2) Gust loads as specified in sections 4b.211 (b) and 4b.215 (b), except that these gust loads shall be considered to be ultimate and the gust velocities shall be as follows:

(i) At speed  $V_B$ , 49 fps from sea level to 20,000 feet altitude, thereafter decreasing linearly to 28 fps at 50,000 feet altitude.

(ii) At speed  $V_C$ , 33 fps from sea level to 20,000 feet altitude, thereafter decreasing linearly to 16.5 fps at 50,000 feet altitude.

(iii) At speed  $V_D$ , 15 fps from sea level to 20,000 feet altitude, thereafter decreasing linearly to 6 fps at 50,000 feet altitude.

(3) Eighty percent of the limit loads resulting from the conditions specified in section 4b.220 (c). These loads shall be considered to be ultimate.

(4) Eighty percent of the limit maneuvering loads resulting from the conditions specified in section 4b.215 (a), except that the load need not exceed 100 percent of the critical load obtained in compliance with the provisions of section 4b.215 (a) using a pilot effort of 180 pounds. This load shall be considered to be ultimate.

[(Amendment 4b-12, published 27 F.R. 2986, Mar. 30, 1962, effective May 3, 1962.)]

4b.270-1 *Flight structure for fatigue evaluation (FAA interpretations which apply to sec. 4b.270).* The term "flight structure" as applied to fatigue evaluation, is defined as those portions of the airplane's structure failure of which could result in catastrophic failure of the aircraft and includes the wings, fixed and movable control surfaces, fuselage, and their related primary attachments.

(23 F.R. 3031, May 7, 1958, effective June 6, 1958.)

4b.270-2 *Fatigue evaluation, general (FAA policies which apply to sec. 4b.270).* The applicant should submit to the FAA a report outlining the procedures and the substantiating analyses and tests he proposes to follow in showing compliance with the fatigue evaluation requirements of section 4b.270. Typical procedures which may be used as guidance in the fatigue evaluation of the structures are discussed in appendix H to the Civil Aeronautics Manual 4b.

(23 F. R. 3031, May 7, 1958, effective June 6, 1958.)

**[4b.271 *Fatigue evaluation of landing gear.*** The strength, detail design, and fabrication of those portions of the landing gear and its attachment fittings in which fatigue may be critical shall be evaluated in accordance with the provisions of either paragraph (a) or (b) of this section.

**[(a)** The fatigue strength of the structure shall be evaluated and, when indicated by such

evaluation, inspection or other procedures shall be established to prevent catastrophic fatigue failure. The evaluation shall include the loading spectrum expected in service and the identification and analysis or repeated load testing of the principal structural elements and detail design points where catastrophic fatigue failure could occur. It shall be acceptable to utilize the service history of airplanes of similar structural design, taking due account of differences in operating conditions and procedures.

**[(b)** It shall be shown by analysis or tests that catastrophic failure is not probable after fatigue failure or obvious partial failure of a single principal structural element. After such failure the remaining structure shall be capable of withstanding static loads corresponding with 80 percent of the limit loads resulting from the conditions prescribed in section 4b.230. These static loads shall be considered ultimate loads.]

**[(Amendment 4b-12, 27 F. R. 2986, Mar. 30, 1962, effective May 3, 1962.)]**

## Subpart D—Design and Construction

### General

**4b.300 *Scope.*** The airplane shall not incorporate design features or details which experience has shown to be hazardous or unreliable. The suitability of all questionable design details or parts shall be established by tests.

4b.300-1 *Turnbuckle safetying (FAA policies which apply to sec. 4b.300).* The procedure outlined in section 4b.329-2 should be followed in safetying turnbuckles.

(20 F. R. 2278, Apr. 8, 1955, effective Apr. 30, 1955.)

**4b.301 *Materials.*** The suitability and durability of all materials used in the airplane structure shall be established on the basis of experience or tests. All materials used in the airplane structure shall conform to approved specifications which will insure their having the strength and other properties assumed in the design data.

4b.301-1 *Acceptability of materials (FAA policies which apply to sec. 4b.301).*

(a) Materials conforming to established industry or military specifications or to Technical Standard Orders issued by the Administrator

are acceptable for use on transport category airplanes. Where new or improved materials are used or where the materials are not covered by specifications sufficient information and data should be submitted to the Administrator to enable him to assess the suitability of the material. In all cases it is the responsibility of the applicant to demonstrate the adequacy of the materials employed.

(20 F. R. 2278, Apr. 8, 1955, effective Apr. 30, 1955.)

**4b.302 *Fabrication methods.*** The methods of fabrication employed in constructing the airplane structure shall be such as to produce a consistently sound structure. When a fabrication process such as gluing, spot welding, or heat treating requires close control to attain this objective, the process shall be performed in accordance with an approved process specification.

**4b.303 *Standard fastenings.*** All bolts, pins, screws, and rivets used in the structure shall be of an approved type. The use of an approved locking device or method is required for all such bolts, pins, and screws. Self-locking nuts shall not be used on bolts which are subject to rotation in operation.

**4b.304 Protection.**

(a) All members of the structure shall be suitably protected against deterioration or loss of strength in service due to weathering, corrosion, abrasion, or other causes.

(b) Provision for ventilation and drainage of all parts of the structure shall be made where necessary for protection.

(c) In seaplanes, special precautions shall be taken against corrosion from salt water, particularly where parts made from different metals are in close proximity.

**4b.305 Inspection provisions.** Means shall be provided to permit the close examination of those parts of the airplane which require periodic inspection, adjustment for proper alignment and functioning, and lubrication of moving parts.

**4b.306 Material strength properties and design values.**

(a) Material strength properties shall be based on a sufficient number of tests of material conforming to specifications to establish design values on a statistical basis.

(b) The design values shall be so chosen that the probability of any structure being understrength because of material variations is extremely remote. The effects of temperature on allowable stresses used for design in an essential component or structure shall be considered where thermal effects are significant under normal operating conditions.

(c) Values contained in MIL-HDBK-5, MIL-HDBK-17 Part I, ANC-17 Part II, ANC-18, MIL-HDBK-23 Part I, and ANC-23 Part II shall be used unless shown to be inapplicable in a particular case.

Note: MIL-HDBK-5, "Strength of Metal Aircraft Elements"; MIL-HDBK-17, "Plastics for Flight Vehicles, Part I—Reinforced Plastics"; ANC-17, "Plastics for Aircraft, Part II—Transparent Glazing Materials"; ANC-18, "Design of Wood Aircraft Structures"; MIL-HDBK-23, "Composite Construction for Flight Vehicles, Part I—Fabrication Inspection Durability and Repair"; and ANC-23, "Sandwich Construction for Aircraft, Part II—Material Properties and Design Criteria", are published by the Department of Defense and the Federal Aviation Agency and may be obtained from the Superintendent of Documents, Government Printing Office, Washington 25, D.C.

(d) The strength, detail design, and fabrication of the structure shall be such as to minimize

the probability of disastrous fatigue failure. (See also sec. 4b.270.)

NOTE: Points of stress concentration are one of the main sources of fatigue failure.

(Amendment 4b-12, published 27 F.R. 2986, Mar. 30, 1962, effectively May 3, 1962.)

4b.306-1 *Material strength properties (FAA policies which apply to sec. 4b.306 (c)).*

(a) In the case of structures where the applied loads are eventually distributed through a single member within an assembly, the failure of which would result in the loss of the structural integrity of the component involved, the guaranteed minimum design mechanical properties ("A" values) listed in MIL-HDBK-5<sup>1</sup> should be used for design.

(b) Redundant structures wherein failure of individual elements would result in the applied load being safely distributed to other load-carrying members, may be designed on the basis of the "90 percent probability" ("B" values).

(c) When strength testing is employed to establish design allowables, such as in the case of sheet-stiffener compression tests, the test results should be reduced through use of a materials correction factor to values which would be met by material having the design allowable material properties for the part under consideration. MIL-HDBK-5 outlines methods of accomplishing this reduction but these are by no means considered as the only methods available.

(d) Use of design values greater than the guaranteed minimums is permissible in applications where only guaranteed minimum values are normally permitted provided that the higher values are substantiated by "premium selection" of the material. These increased design allowables will be acceptable providing that a specimen or specimens of each individual

<sup>1</sup> MIL-HDBK-5 "Strength of Metal Aircraft Elements" specifies "A" and "B" values for allowable design properties. The "A" values are those which the material producer has indicated to be the minimum he expects for the given material. The only values considered guaranteed values are the tensile ultimate and tensile yield "A" values which have been published by the material producer for the grain direction accepted for commercial guarantees. The "B" values represent design properties which the materials producers have indicated will be met or exceeded by 90 percent of the material supplied by them. More detailed information on the derivation of related design mechanical properties can be obtained by referring to section 3.1.1 "Material Properties."

item are tested prior to its use, to assure that the strength properties of the particular item will equal or exceed the properties to be used in design. Such quality control should also be exercised for the manufacture of spare parts.

(20 F.R. 2278, Apr. 8, 1955, effective Apr. 30, 1955; amended 27 F.R. 2986, Mar. 30, 1962, effective May 3, 1962.)

**4b.307 Special factors.** Where there is uncertainty concerning the actual strength of a particular part of the structure, or where the strength is likely to deteriorate in service prior to normal replacement of the part, or where the strength is subject to appreciable variability due to uncertainties in manufacturing processes and inspection methods, the factor of safety prescribed in section 4b.200 (a) shall be multiplied by a special factor of a value such as to make the probability of the part being under-strength from these causes extremely remote. The following special factors shall be used:

(a) **Casting factors.** For structural castings, the factor of safety prescribed in section 4b.200 shall be multiplied by the casting factors specified in subparagraphs (1) and (2) of this paragraph. The prescribed tests and inspections shall be in addition to those necessary to establish foundry quality control. Castings shall be inspected in accordance with approved specifications.

(1) Each casting, the failure of which would preclude continued safe flight and landing of the airplane or which would result in serious injury to occupants, shall have a casting factor of at least 1.25 and shall receive 100 percent inspection by visual, radiographic, and magnetic particle or penetrant inspection methods or approved equivalent nondestructive inspection methods. Where such castings have a casting factor less than 1.50, three sample castings shall be static tested. The test castings shall comply with the strength requirements of section 4b.201 at an ultimate load corresponding with a casting factor of 1.25 and shall comply with the deformation requirements at a load equal to 1.15 times limit load.

NOTE: Examples of castings to which this subparagraph applies are: structural attachment fittings; parts of flight control systems; control surface hinges

and balance weight attachments; seat, berth, safety belt, and fuel and oil tank supports and attachments; cabin pressure valves.

(2) For structural castings other than those specified in subparagraph (1) of this paragraph, the casting factors and inspections shall be in accordance with the following table except that it shall be acceptable to reduce the percentage of castings inspected by nonvisual methods when an approved quality control procedure is established. For castings procured to a specification which guarantees the mechanical properties of the material in the castings and provides for demonstration of these properties by test of coupons cut from castings on a sampling basis, it shall be acceptable to use a casting factor of 1.0. The inspection requirements for such castings shall be in accordance with those specified in the following table for casting factors of 1.25 to 1.50, and the testing requirements shall be in accordance with subparagraph (1) of this paragraph.

Casting factor	Inspections
2.0 or greater.....	100 percent visual.
Less than 2.0 greater than 1.5.	100 percent visual, and magnetic particle or penetrant or equivalent nondestructive inspection methods.
1.25 to 1.50.....	100 percent visual, magnetic particle or penetrant, and radiographic, or approved equivalent nondestructive inspection methods.

(3) Castings which are pressure tested as parts of a hydraulic or other fluid system shall not be required to comply with the provisions of this section unless such castings support airplane structural loads.

(4) The casting factor need not exceed 1.25 with regard to bearing stresses regardless of the method of inspection employed. A casting factor need not be employed with respect to the bearing surface of a part if the bearing factor used (see paragraph (b) of this section) is greater than the casting factor.

(b) **Bearing factors.**

(1) Bearing factors shall be used of sufficient magnitude to provide for the effects of

normal relative motion between parts and in joints with clearance (free fit) which are subject to pounding or vibration. (Bearing factor values for control surface and system joints are specified in sections 4b.313(a) and 4b.329(b).)

(2) A bearing factor need not be employed on a part if another special factor prescribed in this section is of greater magnitude than the bearing factor.

(c) *Fitting factors.*

(1) A fitting factor of at least 1.15 shall be used on all fittings the strength of which is not proven by limit and ultimate load tests in which the actual stress conditions are simulated in the fitting and the surrounding structure. This factor shall apply to all portions of the fitting, the means of attachment, and the bearing on the members joined.

(2) In the case of integral fittings the part shall be treated as a fitting up to the point where the section properties become typical of the member.

(3) The fitting factor need not be employed where a type of joint made in accordance with approved practices is based on comprehensive test data, e. g., continuous joints in metal plating, welded joints, and scarf joints in wood.

(4) A fitting factor need not be employed with respect to the bearing surface of a part if the bearing factor used (see paragraph (b) of this section) is of greater magnitude than the fitting factor.

[Amendment 4b-12, published 27 F. R. 2986, Mar. 30, 1962, May 3, 1962.]

**4b.308 Flutter, deformation, and vibration.** Compliance with the following provisions shall be shown by such calculations, resonance tests, or other tests as are found necessary by the Administrator.

(a) *Flutter prevention.* The airplane shall be designed to be free from flutter of wing and tail units, including all control and trim surfaces, and from divergence (i. e., unstable structural distortion due to aerodynamic loading), at all speeds up to  $1.2 V_D$ . A smaller margin above  $V_D$  shall be acceptable if the characteristics of the airplane (including the effects of compressibility) render a speed of  $1.2 V_D$  unlikely to be achieved, and if it is shown that a proper margin of damping exists at speed  $V_D$ . In the absence of more accurate data, the terminal velocity in a dive of 30 degrees to the horizontal shall be acceptable as the maximum speed likely to be achieved. If concentrated balance weights are used on control surfaces, their effectiveness and strength, including supporting structure, shall be substantiated. If control surface flutter dampers are installed to meet the requirements of this section, it shall be shown that a single failure in the flutter damper system will not preclude continued safe flight of the airplane at any speed up to  $V_D$ .

(b) *Loss of control due to structural deformation.* The airplane shall be designed to be free from control reversal and from undue loss of longitudinal, lateral, and directional stability and control as a result of structural deformation, including that of the control sur-

face covering, at all speeds up to the speed prescribed in paragraph (a) of this section for flutter prevention.

(c) *Vibration and buffeting.* The airplane shall be designed to withstand all vibration and buffeting which might occur in any likely operating conditions.

### Control Surfaces

**4b.310 General.** The requirements of sections 4b.311 through 4b.313 shall apply to the design of fixed and movable control surfaces.

**4b.311 Proof of strength.**

(a) Control surface limit load tests shall be conducted to prove compliance with limit load requirements.

(b) Control surface tests shall include the horn or fitting to which the control system is attached.

(c) Analyses or individual load tests shall be conducted to demonstrate compliance with the special factor requirements for control surface hinges. (See secs. 4b.307 and 4b.313 (a).)

**4b.312 Installation.**

(a) Movable tail surfaces shall be so installed that there is no interference between any two surfaces when one is held in its extreme position and all the others are operated through their full angular movement.

(b) When an adjustable stabilizer is used, stops shall be provided which will limit its travel, in the event of failure of the adjusting mechanism, to a range equal to the maximum required to trim the airplane in accordance with section 4b.140.

**4b.313 Hinges.**

(a) Control surface hinges, except ball and roller bearings, shall incorporate a special factor of not less than 6.67 with respect to the ultimate bearing strength of the softest material used as a bearing.

(b) For hinges incorporating ball or roller bearings, the approved rating of the bearing shall not be exceeded.

(c) Hinges shall provide sufficient strength and rigidity for loads parallel to the hinge line.

### Control Systems

**4b.320 General.**

(a) All controls and control systems shall operate with ease, smoothness, and positiveness

appropriate to their function. The elements of the flight control system shall incorporate design features or shall be distinctively and permanently marked to minimize the possibility of incorrect assembly which could result in malfunctioning of the control system. Tab control systems shall be such that disconnection or failure of any element at speeds up to  $V_C$  cannot jeopardize the safety of flight. (See also secs. 4b.308, 4b.350, and 4b.353.) An adjustable stabilizer shall incorporate means to permit, after the occurrence of any reasonably probable single failure of the actuating system, such adjustment as would be necessary for continued safety of the flight.

(b) Power boost and power-operated control systems shall be designed in accordance with the provisions of subparagraphs (1) and (2) of this paragraph

(1) When a power boost or power-operated control system is used, an alternate system shall be immediately available such that any single failure in the power portion shall not preclude continued safe flight and landing. Such alternate system may be a duplicate power portion or a manually operated mechanical system. The power portion shall include the power source (e.g., hydraulic pumps), and such items as valves, lines, and actuators. The failure of mechanical parts (such as piston rods and links) and the jamming of power cylinders need not be considered if such failure or jamming is considered to be extremely remote.

(2) Both the primary and alternate systems shall be operable in the event of a single engine failure. For airplanes with more than two engines, at least one system shall be operable in the event of failure of any two engines. It shall be shown by analysis that in the event of loss of power on all engines, the airplane is not uncontrollable.

**4b.321 Two-control airplanes.** Two-control airplanes shall be capable of continuing safely in flight and landing in the event of failure of any one connecting element in the directional-lateral flight control system.

**4b.322 Trim controls and systems.**

(a) Trim controls shall be designed to safeguard against inadvertent or abrupt operation.

(b) Each trim control shall operate in the plane and with the sense of motion of the airplane. (See fig. 4b-16.)

(c) Means shall be provided adjacent to the trim control to indicate the direction of the control movement relative to the airplane motion.

(d) Means shall be provided to indicate the position of the trim device with respect to the range of adjustment. The indicating means shall be clearly visible.

(e) Trim devices shall be capable of continued normal operation in the event of failure of any one connecting or transmitting element of the primary flight control system.

(f) All trim control systems shall be designed to prevent creeping in flight. Trim tab controls shall be irreversible, unless the tab is appropriately balanced and shown to be free from flutter.

(g) Where an irreversible tab control system is employed, the portion from the tab to the attachment of the irreversible unit to the airplane structure shall consist of a rigid connection.

**4b.323 Wing flap controls.**

(a) The wing flap controls shall operate in a manner to permit the flight crew to place the flaps in all of the takeoff, en route, approach, and landing positions established under section 4b.111 and to maintain these positions thereafter without further attention on the part of the crew, except for flap movement produced by an automatic flap positioning or load limiting device.

(b) The wing flap control shall be located and designed to render improbable its inadvertent operation.

(c) The rate of motion of the wing flap in response to the operation of the control and the characteristics of the automatic flap positioning or load limiting device shall be such as to obtain satisfactory flight and performance characteristics under steady or changing conditions of air speed, engine power, and airplane attitude.

(d) The wing flap control shall be designed to retract the flaps from the fully extended position during steady flight at maximum continuous engine power at all speeds below  $V_F + 10$  (m. p. h.).

(e) Means shall be provided to indicate the take-off, en route, approach, and landing flap positions.

(f) If any extension of the flaps beyond the landing position is possible, the flap control shall be clearly marked to identify such range of extension.

**4b.324 Wing flap interconnection.**

(a) The motion of wing flaps on opposite sides of the plane of symmetry shall be synchronized by a mechanical interconnection unless the airplane is demonstrated to have safe flight characteristics while the flaps are retracted on one side and extended on the other. When a mechanical interconnection is employed means shall be provided to insure against hazardous unsymmetrical operation of the wing flaps after any reasonably possible single failure of the flap actuating system.

(b) Where a wing flap interconnection is used, it shall be designed to account for the applicable unsymmetrical loads, including those resulting from flight with the engines on one side of the plane of symmetry inoperative and the remaining engines at takeoff power. For airplanes with flaps which are not subjected to slipstream conditions, the structure shall be designed for the loads imposed when the wing flaps on one side are carrying the most severe load occurring in the prescribed symmetrical conditions and those on the other side are carrying not more than 80 percent of that load.

4b.324-1 *Procedure for demonstrating wing flaps that are not interconnected (FAA policies which apply to sec. 4b.324 (a)).* If the wing flaps are not mechanically interconnected, tests should be conducted to simulate flap malfunctioning (to the extent of the flaps being retracted on one side and extended on the other) during takeoffs, approaches, and landings to demonstrate that the airplane is safe under these conditions.

(19 F.R. 4461, July 20, 1954, effective Sept. 1, 1954.)

**4b.325 Control system stops.**

(a) All control systems shall be provided with stops which positively limit the range of motion of the control surfaces.

(b) Control system stops shall be so located in the system that wear, slackness, or take-up adjustments will not affect adversely the con-

trol characteristics of the airplane because of a change in the range of surface travel.

(c) Control system stops shall be capable of withstanding the loads corresponding with the design conditions for the control system.

**4b.326 Control system locks.** Provision shall be made to prevent damage to the control surfaces (including tabs) and the control system which might result from gusts striking the airplane while it is on the ground or water (see also sec. 4b.226). If a device provided for this purpose, when engaged, prevents normal operation of the control surfaces by the pilot, it shall comply with the following provisions.

(a) The device shall either automatically disengage when the pilot operates the primary flight controls in a normal manner, or it shall limit the operation of the airplane in such a manner that the pilot receives unmistakable warning at the start of takeoff.

(b) Means shall be provided to preclude the possibility of the device becoming inadvertently engaged in flight.

**4b.327 Static tests.** Tests shall be conducted on control systems to show compliance with limit load requirements in accordance with the following provisions.

(a) The direction of the test loads shall be such as to produce the most severe loading in the control system.

(b) The tests shall include all fittings, pulleys, and brackets used in attaching the control system to the main structure.

(c) Analyses or individual load tests shall be conducted to demonstrate compliance with the special factor requirements for control system joints subjected to angular motion. (See secs. 4b.307 and 4b.329 (b).)

**4b.328 Operation tests.** An operation test shall be conducted for each control system by operating the controls from the pilot compartment with the entire system loaded to correspond with 80 percent of the limit load specified for the control system. In this test there shall be no jamming, excessive friction, or excessive deflection.

**4b.329 Control system details; general.** All details of control systems shall be designed and installed to prevent jamming, chafing, and interference from cargo, passengers, and loose objects. Precautionary means shall be pro-



vided in the cockpit to prevent the entry of foreign objects into places where they would jam the control systems. Provisions shall be made to prevent the slapping of cables or tubes against other parts of the airplane. The following detail requirements shall be applicable with respect to cable systems and joints.

(a) *Cable systems.*

(1) Cables, cable fittings, turnbuckles, splices, and pulleys shall be of an approved type.

(2) Cables smaller than  $\frac{1}{8}$ -inch diameter shall not be used in the aileron, elevator, or rudder systems.

(3) The design of cable systems shall be such that there will be no hazardous change in cable tension throughout the range of travel under operating conditions and temperature variations.

(4) Pulley types and sizes shall correspond with the cables used.

(5) All pulleys and sprockets shall be provided with closely fitted guards to prevent the cables and chains being displaced or fouled.

(6) Pulleys shall lie in the plane passing through the cable within such limits that the cable does not rub against the pulley flange.

(7) Fairleads shall be so installed that they do not cause a change in cable direction of more than  $3^\circ$ .

(8) Clevis pins (excluding those not subject to load or motion) retained only by cotter pins shall not be used in the control system.

(9) Turnbuckles attached to parts having angular motion shall be installed to prevent positively any binding throughout the range of travel.

(10) Provision for visual inspection shall be made at all fairleads, pulleys, terminals, and turnbuckles.

(b) *Joints.*

(1) Control system joints subjected to angular motion in push-pull systems, excepting ball and roller bearing systems, shall incorporate a special factor of not less than 3.33 with respect to the ultimate bearing strength of the softest material used as a bearing.

(2) It shall be acceptable to reduce the factor specified in subparagraph (1) of this paragraph to a value of 2.0 for joints in cable control systems.

(3) The approved rating of ball and roller bearings shall not be exceeded.

4b.329-1 *Installation of turnbuckles (FAA policies which apply to sec. 4b.329 (a)).* Fork ends of turnbuckles should not be attached directly to control surface horns or to bellcrank arms unless a positive means (such as the use of shackles, links, universal joints, spacer bushings, ball bearings, etc.) is used to prevent binding of turnbuckles relative to the horns or bellcrank arms or unless it can be shown that turnbuckles have adequate strength assuming one end fixed to the horn or arm and the design cable loads pulling off the other end at  $5^\circ$  to the turnbuckle axis. There should be no interference between the horns or bellcrank arms and the fork ends of turnbuckles throughout the range of motion of the control surfaces.

(20 F. R. 2278, Apr. 8, 1955, effective Apr. 30, 1955.)

4b.329-2 *Safetying of turnbuckles (FAA policies which apply to sec. 4b.329).* Section 4b.300 requires in part that there be no design features or details which experience has shown to be hazardous or unreliable. Experience has shown that the reliability of turnbuckles should be insured by safetying with wire as shown in figure 5. After safetying the turnbuckle, no more than three threads should be exposed on either side of the turnbuckle barrel and the ends of each safety wire should be securely fastened by at least four wraps. A turnbuckle safetying guide is given in table 1 (see page 95).

4b.329-3 *Approval of control system components (FAA policies which apply to sec. 4b.329 (a)).* The Administrator does not issue specific approvals as such for cables, cable fittings, turnbuckles, splices, pulleys, etc., for general use on aircraft. Approval is limited to its use as part of a specific airplane design. Conformance with established industry or military specifications or adequate substantiation of the manufacturer's own design, are the procedures utilized in complying with the "approved type" requirement.

(20 F. R. 2279, Apr. 8, 1955, effective Apr. 30, 1955.)

4b.329-4 *Cable terminals (FAA policies which apply to sec. 4b.329 (a)).* The selection of cable terminal locations and their proximities

TABLE 1. TURNBUCKLE SAFETYING GUIDE

Cable size	Minimum Breaking Strength, Pounds				Type of wrap	Diam- eter of safety wire	Material (Annealed Condition)
	MIL-C-1511 Steel (Carbon) Flexible, Pre- formed		[MIL-W-5424] Steel (Corrosion- Resisting) Flexi- ble, Preformed				
	7 x 7	7 x 19	7 x 7	7 x 19			
$\frac{1}{16}$ Inch	480		480		Single	$\frac{1}{16}$ Inch 0.040	Copper, brass, galvanized or tinned steel, soft iron, or monel.
$\frac{1}{32}$	920		920		Single	.040	Copper, brass, galvanized or tinned steel, soft iron, or monel.
$\frac{1}{4}$		2000		1760	Single	.040	Stainless steel.
$\frac{1}{8}$		2000		1760	Double	.040	Copper, brass, galvanized or tinned steel, soft iron, or monel.
$\frac{1}{32}$ and greater		2800		2400	Double	.040	Galvanized or tinned steel, soft iron, stainless steel, or monel.
$\frac{1}{16}$ and greater		2800		2400	Double	.051	Copper, brass.

## NOTES

1. The swaged and unswaged turnbuckle assemblies are covered by AN Standard Drawings.
2. Certain of the AN Std. swaged terminal parts specify a safety wire hole size of .047 in. This hole may be reamed sufficiently to accommodate the .040 and .051 diameter wires.
3. The double wrap procedure given in Navy Specification PO-42A, Amendment No. 1, or the safetying procedure described by [Military Standard Drawing MS33591 (ASG)], may be used in lieu of the method shown in Figure 5.

(20 F. R. 2278, Apr. 8, 1955, effective Apr. 30, 1955; [amended 27 F. R. 2986, Mar. 30, 1962, effective May 3, 1962.]

should minimize the possibility of interferences with structure, fairleads, other terminals, etc., and the possibility of pairing wrong cables during maintenance or overhaul.

(20 F. R. 2279, Apr. 8, 1955, effective Apr. 30, 1955.)

4b.329-5 *Bellcrank and idler installation* (FAA policies which apply to sec. 4b.329 (b)). The design of such items as bellcrank arms, tab drums, idlers, etc., should minimize the possibility of inadvertent installation in the reversed direction, or, as an alternative, to preclude the possibility of jamming or interference that might result from such reversed installation.

(20 F. R. 2279, Apr. 8, 1955, effective Apr. 30, 1955.)

4b.329-6 *Ball and roller bearings* (FAA policies which apply to sec. 4b.329 (b) (3)). The "approved ratings" of ball and roller bearings referred to are the ratings established in

[MIL-HDBK-5] "Strength of Metal Aircraft Elements".

(20 F. R. 2279, Apr. 8, 1955, effective Apr. 30, 1955; [amended 27 F. R. 2986, Mar. 30, 1962, effective May 3, 1962.]

## Landing Gear

4b.330 *General*. The requirements of sections 4b.331 through 4b.338 shall apply to the complete landing gear.

4b.331 *Shock absorbers*.

(a) The shock absorbing elements for the main, nose, and tail wheel units shall be substantiated by the tests specified in section 4b.332.

(b) The shock absorbing ability of the landing gear in taxiing shall be demonstrated by the tests prescribed in section 4b.172.

4b.332 *Landing gear tests*. The landing gear shall withstand the following tests.

**(a) Shock absorption tests.**

(1) It shall be demonstrated by energy absorption tests that the limit load factors selected for design in accordance with section 4b.230 (b) for take-off and landing weights, respectively, will not be exceeded.

(2) In addition to the provisions of subparagraph (1) of this paragraph, a reserve of energy absorption shall be demonstrated by a test simulating an airplane descent velocity of 12 f. p. s. at design landing weight, assuming wing lift not greater than the airplane weight acting during the landing impact. In this test the landing gear shall not fail. (See paragraph (c) of this section.)

**(b) Limit drop tests.**

(1) If compliance with the limit landing conditions specified in paragraph (a) (1) of this section is demonstrated by free drop tests, these shall be conducted on the complete airplane, or on units consisting of wheel, tire, and shock absorber in their proper relation. The free drop heights shall not be less than the following:

- (i) 18.7 inches for the design landing weight conditions,
- (ii) 6.7 inches for the design takeoff weight conditions.

(2) If wing lift is simulated in free drop tests the landing gear shall be dropped with an effective mass equal to:

$$W_e = W \left( \frac{h + (1-L)d}{h+d} \right);$$

where:

$W_e$  = the effective weight to be used in the drop test (lbs.),

$h$  = specified free drop height (inches),

$d$  = deflection under impact of the tire (at the approved inflation pressure) plus the vertical component of the axle travel relative to the drop mass (inches),

$W = W_M$  for main gear units (lbs.), equal to the static weight on the particular unit with the airplane in the level attitude (with the nose wheel clear in the case of nose wheel type airplanes),

$W = W_T$  for tail gear units (lbs.), equal to the static weight on the tail unit with the airplane in the tail-down attitude,

$W = W_N$  for nose wheel units (lbs.), equal to the vertical component of the static reaction which would exist at the nose wheel, assuming the mass of the airplane acting at the center of gravity and exerting a force of 1.0g downward and 0.25g forward,

$L$  = the ratio of the assumed wing lift to the airplane weight, not in excess of 1.0.

(3) The attitude in which a landing gear unit is drop tested shall simulate the airplane landing condition critical for the unit.

(4) The value of  $d$  used in the computation of  $W_e$  in subparagraph (2) of this paragraph shall not exceed the value actually obtained in the drop test.

**(c) Reserve energy absorption drop tests.**

(1) If compliance with the reserve energy absorption condition specified in paragraph (a)

(2) of this section is demonstrated by free drop tests, the landing gear units shall be dropped from a free drop height of not less than 27 inches.

(2) If wing lift equal to the airplane weight is simulated, the units shall be dropped with an effective mass equal to:

$$W_e = W \left( \frac{h}{h+d} \right);$$

where the symbols and other details are the same as in paragraph (b) of this section.

**4b.333 Limit load factor determination.**

(a) In determining the airplane inertia limit load factor  $n$  from the free drop tests specified in section 4b.332, the following formula shall be used:

$$n = n_j \frac{W_e}{W} + L;$$

where:

$n_j$  = the load factor during impact developed on the mass used in the drop test (i. e., the acceleration  $dv/dt$  in g's recorded in the drop test plus 1.0). (See sec. 4b.332 (b) (2) for explanation of  $W_e$ ,  $W$ , and  $L$ .)

(b) The value of  $n$  determined in paragraph (a) of this section shall not be greater than the limit load factor used for the landing conditions. (See sec. 4b.230 (b).)

**4b.334 Retracting mechanism.****(a) General.**

(1) The landing gear retracting mechanism, wheel well doors, and supporting structure shall be designed for the loads occurring in the flight conditions when the gear is in the retracted position, and for the combination of friction, inertia, brake torque, and air loads occurring during retraction and extension at any air speed up to  $1.6 V_{S1}$  (flaps in the approach position at design landing weight), and any load factor up to those specified in section 4b.212 for the flaps extended condition.

(2) The landing gear, the retracting mechanism, and the airplane structure including wheel well doors shall be designed to withstand the flight loads occurring with the landing gear in the extended position at any speed up to  $0.67 V_C$ , unless other means are provided to decelerate the airplane in flight at this speed.

(3) Landing gear doors, their operating mechanism, and their supporting structure shall be designed for the conditions of air speed and load factor prescribed in subparagraphs (1) and (2) of this paragraph, and in addition they shall be designed for the yawing maneuvers prescribed for the airplane.

(b) *Landing gear lock.* A positive means shall be provided for the purpose of maintaining the landing gear in the extended position. A means shall be provided to prevent the retraction of the landing gear while the airplane is on the ground.

(c) *Emergency operation.* Emergency means of extending the landing gear shall be provided, so that the landing gear can be extended in the event of any reasonably probable failure in the normal retraction system. In any case the emergency system shall provide for the failure of any single source of hydraulic, electric, or equivalent energy supply.

(d) *Operation test.* Proper functioning of the landing gear retracting mechanism shall be demonstrated by operation tests.

**(e) Position indicator and warning device.**

(1) When a retractable landing gear is used, means shall be provided for indicating to the pilot when the gear is secured in the extended and in the retracted positions.

[NOTE: An acceptable method for indicating to the pilot when the landing gear is secured in the extended

and in the retracted positions is by means of lights. For example, landplanes may display a green light when the landing gear is down and locked; a red light to indicate an intermediate or unlocked landing gear position; and "all lights out" when the landing gear is up and locked. An acceptable method for sensing when the landing gear is secured in the extreme positions is to locate the sensing devices so that they are operated by the landing gear locking latch.]

(2) In addition to the requirement of subparagraph (1) of this paragraph, landplanes shall be provided with an aural warning device which will function continuously when [one or more] throttles are closed if the gear is not fully extended and locked.

(3) If a manual shutoff for the warning device prescribed in subparagraph (2) of this paragraph is provided, it shall be installed so that reopening the throttles will reset the warning mechanism.

(f) *Control.* The location and operation of the landing gear retraction control shall be according to the provisions of section 4b.353.

[(g) *Protection of equipment in wheel wells.* Equipment located in wheel wells, which is essential to safe operation of the airplane, shall be protected from the damaging effects of a bursting tire unless it is shown that a tire cannot burst from overheat, or from the damaging effects of a loose tire tread unless it is shown that a loose tire tread cannot cause damage.]

[(Amendment 4b-12, published 27 F.R. 2986, Mar. 3, 1962, effective May 3, 1962.)]

4b.334-1 *Procedure for testing landing gear retracting system (FAA policies which apply to sec. 4b.334).*

(a) *General, section 4b.334 (a).* The ability to extend and retract the landing gear at a speed of at least  $1.6 V_{S1}$  should be demonstrated. If no other satisfactory means of decelerating the airplane are provided (such as dive brakes or other high drag devices), the ability of the landing gear retracting mechanism and wheel well doors to withstand the flight loads should be demonstrated under the following conditions:

Power required for level flight.

Airspeed, at least  $0.67 V_C$ .

Landing gear extended.

(b) *Emergency operation, section 4b.334 (c).* Extending the landing gear by use of the emergency system for demonstrating compliance

with the requirement of this section may be accomplished during other tests in the flight program.

(c) *Operation test, section 4b.334 (d)*. The time required to retract the landing gear at speed  $V_2$  (see sec. 4b.116 (b)) should be demonstrated in flight under the following conditions:

Weight—optional.

C. G. position—optional.

Operating engine(s)—takeoff power.

Critical inoperative engine—propeller windmilling on engine most critical from the gear retraction standpoint.

It is also desirable to obtain the time required to extend the landing gear for purposes of information.

(19 F. R. 4961, July 20, 1954, effective Sept. 1, 1954.)

4b.334-2 *Landing gear position indicator switches (FAA interpretations which apply to sec. 4b.334 (e))*. The phrase "means shall be provided for indicating to the pilot" includes a landing gear position indicator as well as the switches necessary to actuate such indicator. The switches must be so located and coupled to the landing gear mechanical system as to preclude the possibility of an erroneous indication of "down and locked" if the landing gear is not in a fully extended position, or "up and locked" if the landing gear is not in the completely retracted position. Location of the switches so that they are operated by the actual landing gear locking latch or device is an acceptable method of compliance with the requirements of this section.

(21 F. R. 2747, Apr. 28, 1956, effective May 25, 1956.)

4b.335 *Wheels*. Main wheels and nose wheels shall be of an approved type. The following provisions shall apply.

(a) The maximum static load rating of each main wheel and nose wheel shall not be less than the corresponding static ground reaction under the design takeoff weight of the airplane and the critical center of gravity position.

(b) The maximum limit load rating of each main wheel and nose wheel shall not be less than the maximum radial limit load determined in accordance with the applicable ground load

requirements of this part (see secs. 4b.230 through 4b.236).

(c) The brake kinetic energy capacity rating of each main wheel-brake assembly shall not be less than the kinetic energy absorption requirement determined in accordance with this paragraph. The brake kinetic energy absorption requirements shall be based on a rational analysis of the sequence of events which are expected to occur during operational landings at maximum landing weight. This analysis shall include conservative values of airplane speed at which the brakes are applied, braking coefficient of friction between tires and runway, aerodynamic drag, propeller drag or powerplant forward thrust, and if more critical, the most adverse single engine or propeller malfunction. In lieu of a rational analysis it shall be acceptable to establish the kinetic energy absorption requirements for each main wheel brake assembly by the following formula:

$$KE = \frac{0.0334 WV_s^2}{N};$$

where:

$KE$  = kinetic energy per wheel (ft. lb.);

$W$  = design landing weight (lb.);

$V_s$  = power-off stalling speed of the airplane (mph) at sea level at the design landing weight and in the landing configuration;

$N$  = number of main wheels.

NOTE: The expression for kinetic energy assumes an equal distribution of braking between main wheels. In cases of unequal distribution the expression requires appropriate modification.

(d) The minimum stalling speed rating of each main wheel-brake assembly, i. e., the initial speed used in the dynamometer tests, shall not be greater than the  $V_s$  used in the determination of kinetic energy in accordance with paragraph (c) of this section.

NOTE: The provision of this paragraph is based upon the assumption that the testing procedures for wheel-brake assemblies involve a specified rate of deceleration, and, therefore, for the same amount of kinetic energy the rate of energy absorption (the power absorbing ability of the brake) varies inversely with the initial speed.

4b.336 *Tires*. Landing gear tires shall be of a proper fit on the rim of the wheel, and of

load ratings which are not exceeded under the following conditions:

(a) Main wheel tires: Equal static loads on all main wheel tires corresponding with the most critical combination of maximum takeoff weight and center of gravity position.

(b) Nose wheel tires: Equal loads on all nose wheel tires corresponding with the following conditions:

(1) The static ground reaction per tire corresponding with the most critical combination of takeoff weight and center of gravity position. This load shall correspond with the static rating of the tire.

(2) The dynamic ground reaction per tire at maximum landing weight, assuming the mass of the airplane concentrated at the most critical location of the center of gravity for this weight and exerting a force of 1.0g downward and 0.31g forward, the reactions being distributed to the nose and main wheels by the principles of statics with a 0.31g drag reaction at the ground applied at those wheels which have brakes. This load shall correspond with the dynamic rating of the tire.

(3) The dynamic ground reaction per tire at design takeoff weight, assuming the mass of the airplane concentrated at the most critical location of the center of gravity for this weight and exerting a force of 1.0g downward and 0.20g forward, the reactions being distributed to the nose and main wheels by the principles of statics with a 0.20g drag reaction at the ground applied at those wheels which have brakes. This load shall correspond with the dynamic rating of the tire.

#### 4b.337 Brakes.

##### (a) General.

(1) The airplane shall be equipped with brakes of an approved type. The brake ratings

shall be in accordance with section 4b.335 (c) and (d).

(2) The brake system shall be so designed and constructed that in the event of a single failure in any connecting or transmitting element in the brake system (excluding the operating pedal or handle), or the loss of any single source of hydraulic or other brake operating energy supply, it shall be possible to bring the airplane to rest under conditions specified in section 4b.122 with a mean deceleration during the landing roll of at least 50 percent of that obtained in determining the landing distance as prescribed in that section.

(3) In applying the requirement of subparagraph (2) of this paragraph to hydraulic brakes, the brake drum, shoes, and actuators (or their equivalents) shall be considered as connecting or transmitting elements, unless it is shown that the leakage of hydraulic fluid resulting from failure of the sealing elements in these units would not reduce the braking effectiveness below that specified in subparagraph (2) of this paragraph.

(b) *Brake controls.* Brake controls shall not require excessive control forces in their operation.

(c) *Parking brake controls.* A parking brake control shall be provided and installed so that it can be set by the pilot and, without further attention, will maintain sufficient braking to prevent the airplane from rolling on a paved, level runway while takeoff power on the critical engine is being applied.

(d) *Antiskid devices.* If antiskid devices are installed, the devices and associated systems shall be such that no single probable malfunction will result in a hazardous loss of braking ability or directional control of the airplane.

### Discussion of Policies Relating to Brake Tests in Section 4b.337-1

The requirements of section 4b.337 are based upon the fact that compliance with the operating rules of section 40.70 of this subchapter will require great dependence upon the presence and proper functioning of brakes unless the runways involved are unusually long.

The nature and extent of the tests to show compliance with section 4b.337 (a) will necessarily depend upon a great many things such as the general arrangement of the landing gear, the design of the brake system, the extent to which the capacity of the brakes is used in establishing the landing distance

required by section 4b.122, the amount of available performance data for the brakes, etc. The simplest possible procedure appears to be to determine the average deceleration during a landing ground roll without the use of brakes and then establish the landing distance required by section 4b.122 by using the brakes to the extent necessary to double the mean deceleration so established. It appears likely, however, that this procedure would result in excessive landing distance and might seriously limit the use of the airplane in operation.

4b.337-1 *Brake tests (FAA policies which apply to sec. 4b.337)*. If it is desired by the applicant to make the maximum possible use of the brakes in establishing the landing distance, and if also the contribution of the brakes to the total deceleration is relatively large, the brake system should be designed to permit the application of slightly less than half the braking deceleration developed under the conditions specified in this section. The following dual system is recommended: Dual wheel elements (drums or disc units), transmitting elements, power sources, master cylinders, etc., connected to a single pedal on each rudder pedal, such that the failure of any single one of these would leave half the total braking capacity symmetrically disposed about the plane of symmetry of the airplane. With such a system it should be possible to show compliance with section 4b.337 (a) by means of calculation based upon the test data necessary to establish the landing distance plus the brake data calculated by the aircraft manufacturer.

If the system is designed so that under the conditions here specified appreciably less than half the total braking capacity remains or if the remaining capacity is asymmetrically disposed, tests should be conducted to determine that half the mean deceleration may in fact be developed and/or that the airplane may be safely controlled directionally while doing so.

(a) Rescinded.

(b) *Brake controls, section 4b.337 (b)*. General brake control force and operation should be noted throughout the flight test program to determine that they are satisfactory.

(c) *Parking brake controls, section 4b.337 (c)*. During engine runup prior to takeoff for other tests, the parking brake control should be set, and without further attention, a demonstration should be made to determine that sufficient braking is maintained to prevent the airplane

from rolling on a paved runway while takeoff power is applied on the most critical engine.

(19 F. R. 4461, July 20, 1954, effective Sept. 1, 1954; amended 22 F. R. 6963, Aug. 29, 1957, effective Sept. 15, 1957.)

4b.337-2 *Brake systems (FAA policies which apply to sec. 4b.337)*. In order to obtain a minimum landing distance under section 4b.122 and at the same time meet the deceleration requirement of section 4b.337 (a) (2) in event of failure of the normal brake system, it is a common practice to provide an alternate brake system. When hydraulic (or pneumatic) brakes are used in the normal brake system, this alternate means usually consists of a duplicate hydraulic or pneumatic brake system and is commonly referred to as the "emergency brake system." The following items should be considered in the design of such systems:

(a) *Relationship between normal and emergency brake systems*. The systems for actuating the normal brake and the emergency brake should be so separated that a failure in, or the leakage of fluid from, one system will not render the other system inoperative. A hydraulic brake assembly may be common to both the normal and emergency brake systems if it is shown that the leakage of hydraulic fluid resulting from failure of the sealing elements in the brake assembly would not reduce the braking effectiveness below that specified in section 4b.337 (a) (2).

(b) *Brake control valves*. In the normal brake system of all aircraft, the brake control valves should be of a type such that the pilots may exercise variable control of the pressure to the brakes. The foregoing provision need not necessarily apply to the emergency brake systems although obviously such a provision would be desirable. Flight tests should be conducted to determine that the normal and emer-

gency brake systems fulfill the requirements of section 4b.170 (a) and (b).

In the normal brake systems of tail wheel type aircraft or of nose wheel type aircraft equipped with nonsteerable nose wheels, provisions should be made for independently controlling the brakes on either side of the main landing gear in order that directional control of the aircraft can be maintained. (See sec. 4b.171 (c).) In the emergency brake systems of tail wheel type aircraft and in the normal and emergency brake systems of nose wheel type aircraft, it is desirable that independent control of the brakes on either side of the landing gear be provided although such control is optional.

(19 F. R. 4461, July 20, 1954, effective Sept. 1, 1954.)

4b.337-3 *Replacement or modified brakes (FAA policies which apply to sec. 4b.337).*

(a) *General.* Replacement or modified brake installations may be approved on the basis of dynamometer tests together with functional flight tests in lieu of measured accelerate-stop and landing distance flight tests if the decelerate performance based on dynamometer data is shown to be equal to or better than the original airplane flight test decelerate performance. Dynamometer tests which simulate actual airplane decelerate-distance tests may incorporate variable kinetic energy absorption rates simulating flight test deceleration conditions, and may include an energy allowance for the aerodynamic drag of the airplane which occurs during the deceleration portion of the accelerate-stop and landing runs. However, if any improvement in decelerate performance over that shown in the original Airplane Flight Manual is desired, then this policy is inapplicable and complete airplane flight tests will be required.

(1) The procedures of paragraphs (c) through (g) of this section may be used for substantiating replacement or modified brake installations and may be applied to approved brakes of any manufacturer. The replacement brake does not have to be manufactured by the maker of the original brake.

(2) Brakes which have been approved under TSO or preceding approval standards (whichever is pertinent) may be approved as a

replacement brake on an existing airplane type upon the presentation of test reports and other pertinent computations showing:

(i) That, insofar as deceleration performance is concerned, the replacement or modified brakes are equal to or better than the original brake installation on the basis of dynamometer tests contained in this section, and

(ii) That, the replacement or modified brakes when installed on the airplane, comply with the ground handling requirements of section 4b.170.

(b) *Brake modifications.* Modifications to a previously approved wheel-brake installation involving changes to component parts which will involve variations in kinetic energy absorption characteristics should be subjected to the dynamometer tests contained in subparagraph (1) of this paragraph in addition to the dynamometer tests specified in paragraphs (e) and (f) of this section for the accelerate-stop and landing conditions and should also include a check of operating and ground handling characteristics. Typical modifications which vary the kinetic energy absorption characteristics are as follows: changes of brake lining material, changes in brake discs or brake drum material, reductions in friction surface plan dimensions (area), etc.

(1) The minimum reliability standards for brakes referenced in TSO-C26 and contained in Specification AS227A should be used as a guide for modified brakes. However, section 5.4.3 of AS227A may be applied as follows for evaluating such modifications:

(i) Thirty tests simulating the stopping of an airplane at 100 percent kinetic energy.<sup>9</sup>

(ii) One test simulating the stopping of an airplane at 125 percent kinetic energy.<sup>9</sup>

(c) *Determination of kinetic energy requirements.*

(1) In the case of replacement brakes (that is, those brakes incorporating major design differences from those originally tested on the airplane) the kinetic energy (KE) to be absorbed on the dynamometer in compliance with

<sup>9</sup> The modifier of the brake should substantiate the fact that the original brake approval tests and the tests specified in (i) and (ii) were conducted under similar conditions and that the modified brake assembly is at least the equal to that previously approved as an equipment item insofar as energy absorption and stopping time are concerned.



provision (a) (2) of this section should be determined in accordance with the following formula:

$$KE_{dyn} = KE_{wv} - \frac{1}{2} KE_{ad}$$

where:

$KE_{wv}$  = the maximum kinetic energy as determined from the most critical combination of weight and speed (in terms of ground speed). In determining the maximum speed, the effects of tailwind, altitude and flap setting should be taken into account.

$KE_{ad}$  = the kinetic energy absorbed by aerodynamic drag of the airplane during the deceleration portion of the accelerate-stop and landing runs. This kinetic energy should be determined from available test data of the airplane or by other reliable calculations based on the basic parameters for the type of airplane involved.

(2) In the case of brakes modified as described in paragraph (b) of this section the kinetic energy to be absorbed on the dynamometer should be determined in accordance with the following formula:

$$KE_{dyn} = KE_{wv} - KE_{ad}$$

(i) This formula should not apply to modifications of a replacement brake which has been approved in accordance with subparagraph (1) of this paragraph. Such modifications of a replacement brake should meet the same dynamometer requirements as the replacement brake did when originally installed.

(d) *Dynamometer test method.*

(1) There should be no artificial cooling of the brakes during dynamometer tests. Ventilating air flowing normal to the tire tread is permissible.

(2) For wheel-brake installations where dual or duplex brakes are used, the dynamometer tests should be conducted on an entire wheel-brake unit.

(3) Brake lining should not be run-in to a degree which would be greater than the run-in for new lining when installed on an airplane prior to being put in regular airline service.

(4) Due to wing-lift acting on the airplane, the dynamometer tests should account for tire rolling friction due to the differential in braking

effect resulting from the varying rolling radius of the tire on the runway as compared to the constant tire radius at constant tire deflection which occurs throughout the entire dynamometer run.

(5) The dynamometer mass should be corrected so that the selected inertia equivalent (I.E.) will result in a correct or conservative kinetic energy test value.

(6) During dynamometer testing a variable brake pressure, which does not exceed that pressure which is available from the airplane brake system intended for use with the replacement brake, should be used in duplicating as nearly as practicable the original airplane torque-speed and velocity-time flight test data corrected for aerodynamic drag and tire rolling friction.

(e) *Accelerate-stop distance test.* This condition is normally the most critical from a kinetic energy standpoint. The original flight test accelerate-stop deceleration camera data obtained during the type certification tests of the airplane should be obtained and corrected for aerodynamic drag and tire rolling friction.

(1) Continuous records of dynamometer torque-speed or velocity-time data for at least three of the runs, when absorbing the required kinetic energy for the critical combination of takeoff weight and  $V_1$  speed, should duplicate, as nearly as practical, the original airplane brake deceleration data. These dynamometer records should be converted to corrected and faired velocity versus distance values and be plotted and superimposed on the curve for the original airplane velocity-distance data, and

(2) The average of the above three corrected dynamometer velocity-distance curves should be superimposed on the curve for the original airplane velocity-distance data.

(3) The curves plotted in subparagraphs (1) and (2) of this paragraph should compare favorably with the original corrected flight data over the entire speed range and should indicate that, from any given speed, the airplane stopping distance would be equal to or less than the distance resulting from the original brake installation at the required kinetic energy level corresponding to the actual accelerate-stop conditions which prevailed during the airplane type certification tests.

(4) If, in compliance with subparagraph (1) of this paragraph, velocity-time data are submitted in lieu of torque-speed data, then sufficient spot-check calculations of the velocity-time data should be made to insure an accuracy comparable to the accuracy of torque-speed data. Inasmuch as torque-speed data are useful for airplane modification and design purposes, it is desirable that comparable and complete torque-speed data be included in the data submitted.

(5) Dynamometer time history recordings of brake pressure, torque, speed, and calculations for aerodynamic drag, tire rolling friction, and dynamometer mass correction, and all pertinent airplane data, should be submitted, together with an analysis showing the detailed calculations and charts necessary to establish the speed-distance relationship and comparison with the original airplane deceleration test data.

(f) *Landing distance test.* In order to substantiate landing distances, at least three dynamometer runs, using the critical combinations of landing weight and contact speed, should be conducted on the same brake unit. Landing distance data, compiled in accordance with the method described in paragraph (e) of this section for accelerate-stop evaluation, should be submitted. The landing distance data, which are comparable to those of paragraph (e) of this section for the accelerate-stop data, should compare favorably with the corrected airplane flight test results obtained with the original brakes in order to substantiate the adequacy of the replacement brakes, insofar as landing distances are concerned.

(g) *Aircraft functional tests.* The brakes should be tested on the airplane to determine their functional characteristics as indicated in paragraph (a) (2). Functioning characteristics should be observed during taxi and engine run-up conditions and at least three normal takeoffs and landings, at the maximum landing weight, should be conducted. During these tests, the brakes should be checked for any undesirable characteristics such as "grabbing," "fading," etc., and should at least be visually inspected, without dismantling, at the completion of the test in order to determine any evidence of malfunction or failure. If no malfunctioning has occurred, this visual inspection is adequate,

but if malfunctioning does occur, a thorough inspection should be conducted. If any characteristics arise which indicate that stopping distances would exceed the original values in the FAA Approved Airplane Flight Manual, then the Administrator may require actual camera recorded airplane deceleration tests or any other tests deemed necessary to establish the adequacy of the brakes.

(19 F. R. 4463, July 20, 1954, effective Sept. 1, 1954.)

4b.337-4 *Antiskid devices and installations (FAA policies which apply to sec. 4b.337).*

(a) *Eligibility.* Antiskid devices meeting the airworthiness portions of Military Specification MIL-B-8075 (ASG) and any amendments<sup>10</sup> thereto, are acceptable for installation on civil aircraft. Requests for deviations from these specifications should be submitted to the FAA Regional Office, Engineering and Manufacturing Branch. The installation of the antiskid device should comply with the requirements specified in paragraph (b) of this section. The antiskid device and its installation will be approved for use on civil aircraft when the tests specified in paragraph (c) of this section have been satisfactorily demonstrated.

(b) *Installation.*

(1) *Data required.* An engineering evaluation of the antiskid installation as installed on the airplane, including all necessary components, should be conducted. This analysis and complete descriptive data should be submitted to the FAA. The data should include hydraulic and electric schematic diagrams of the installation, assembly drawings of antiskid system units, test results or stress analysis substantiating structural strength of attachments and modification of the axle or other structural members, installation drawings, recommended instructions pertaining to installation, maintenance and operation and analysis of flight test data and results. Schematic drawings should refer to all units in the normal and emergency brake systems. The engineering evaluation should also assure that the antiskid system does not cause undesirable and adverse yaw characteristics.

<sup>10</sup> Proposed amendments may be obtained from the Federal Aviation Agency, Washington 25, D. C.

(i) Engineering evaluation should account for a bounce condition wherein the wheels may leave the runway after the brakes have been applied, for a condition wherein the wheels stay on the runway but the oleos are extended (if the system utilizes landing gear oleo compression in its operation), and for a condition in which the wheels of one main gear may not be in contact with the runway for a considerable time while the wheels of the other main gear are firmly on the runway. If the antiskid installation incorporates the "landing with brake pedals depressed" feature, then this type of operation should also be considered.

(ii) It should be shown that the brake cycling frequency imposed by the antiskid installation will not result in excessive loads on the landing gear because of proximity to resonant landing gear frequencies.

(2) *Systems.* The entire brake system (including both the basic brake system and the antiskid system) should conform to section 4b.337. The single failure criterion of section 4b.337 should be extended to include the antiskid system.

(i) In the event of a probable malfunction within the antiskid system which would result in loss of the antiskid feature in one or more brake units, those brake units affected should automatically revert to normal braking.

(ii) Deleted.

(iii) A means should be provided so that the pilot or copilot can readily deactivate the antiskid system. For simple mechanical type antiskid installations wherein any single probable malfunction is considered remote and which will render only one braked wheel inoperative insofar as antiskid operation is concerned, the deactivating means need not be located in the cockpit.

(iv) Antiskid installations should not cause surge pressures in the brake hydraulic system which would be detrimental to either the normal or emergency brake system and components.

(v) The antiskid equipment should insure satisfactory operation on slippery runways as well as on dry hard surfaced runways without additional antiskid adjustments.

(c) *Tests and analyses.*

(1) When an antiskid system is included as original equipment on an airplane, it is not required that field length data,<sup>11</sup> with antiskid inoperative, be determined.

(2) Tests and analyses for the approval of an antiskid system to be used with a previously approved brake installation, without consideration for reduction of runway distances, should be conducted in accordance with this paragraph. When equivalent alternate procedures are developed and approved, they may be used in lieu of the method specified in this paragraph. If credit for shorter field lengths is requested on the basis of an antiskid installation, then complete flight tests should be conducted in accordance with sections 4b.115, 4b.122, 4b.123, 4b.170 and 4b.171.

(3) When an antiskid system is installed, the braking performance and airplane stopping distances should be at least equivalent to those obtained during the accelerate-stop and landing type certification tests. The tests to be conducted are based on the high speed condition as being critical, both for airplane braking as controlled by the antiskid system, and for the functional integrity of an acceptable antiskid device. However, should it become necessary for a particular type of installation, these tests may be modified as warranted.

(i) Conduct at least one accelerate-stop test at each of the following speeds: 80, 90, and 100 percent of the highest  $V_1$  speed for which the airplane is certificated.<sup>12</sup> The maximum landing weight, or the lowest weight above maximum landing weight necessary to keep the airplane from leaving the runway at the highest  $V_1$  speed, should be used in the above three tests. When appropriate, the decelerate portions of the accelerate-stop tests may be demonstrated by landings with wing flaps in takeoff position in lieu of accelerating the airplane to  $V_1$  speed on the runway. (See also sec. 4b.115-1.)

<sup>11</sup> It is desirable to determine field length data with the antiskid inoperative in order that airplane operation may be conducted with antiskid inoperative if so desired by the operator.

<sup>12</sup> In order to assure stopping distances equivalent to those shown in the Airplane Flight Manual, camera recording, or equivalent recordation methods should be used. To ascertain that the measured stopping distances are equivalent to those in the Airplane Flight Manual it will be necessary to compare the measured antiskid data with the data obtained during the manufacturer's original certification tests for the weight used in the antiskid tests at the highest speed for that weight shown in the Airplane Flight Manual.

(ii) Conduct at least one landing deceleration test at each of the following weights: maximum landing weight, an intermediate landing weight and normal minimum landing weight.<sup>13</sup> All landings should be made from the highest corresponding contact speeds used in determining FAA Approved Airplane Flight Manual field lengths.

(4) Conduct controllability tests in accordance with sections 4b.170 and 4b.171 (except for the emergency braking condition) after the occurrence of any single malfunction within the antiskid system (excluding the device and those components which were determined to be satisfactory based on laboratory tests). Single probable malfunctions, which analysis indicates may be likely to occur, should be simulated during landing or simulated landing deceleration tests. If analysis shows clearly that a particular malfunction would not adversely affect controllability, that malfunction need not be simulated in flight tests.

(5) Conduct taxi tests to demonstrate that repeated rapid full brake pedal application and release does not result in excessive delay in brake reapplications and that ground handling maneuvering characteristics and sensitivity of braking effect are satisfactory.

(6) Conduct tests and analyses to determine the effect of automatic cyclic brake action on the emergency brake system fluid supply. The fluid volume (reserved for emergency use in the reservoir or emergency accumulators of the basic brake system) may be adequate for manual braking but may be adversely affected by an antiskid installation. Hence, an engineering evaluation should be conducted to show that the antiskid system will not have an adverse effect on braking when the airplane is stopped by means of the emergency brake system, or to show that the antiskid system is automatically made inoperative when emergency braking is used.

(7) If, during the tests specified in this paragraph, adjustments or modifications to the antiskid device or its installation proved neces-

<sup>13</sup> If it can be shown by the accelerate-stop distance tests conducted and the data obtained in subdivision (i) of this subparagraph that the landing distances when using normal landing braking techniques, would not exceed the landing distances approved without antiskid devices, then the landing distance tests specified in subdivision (ii) of this subparagraph need not be conducted.

sary and indicated the possibility of encountering unreliable operation due to maintenance difficulties or the need for frequent adjustments, then accelerated service functioning and reliability tests should be conducted as deemed necessary.

(21 F. R. 2558, Apr. 18, 1956, effective May 15, 1956; amended 23 F. R. 2789, Apr. 26, 1958, effective May 5, 1958.)

**4b.338 Skis.** Skis shall be of an approved type. The maximum limit load rating of each ski shall not be less than the maximum limit load determined in accordance with the applicable ground load requirements of this part. (See secs. 4b.230 through 4b.236.)

### Hulls and Floats

**4b.340 General.** The requirements of sections 4b.341 and 4b.342 shall apply to the design of hulls and floats.

**4b.341 Seaplane main floats.** Seaplane main floats shall be of an approved type and shall comply with the provisions of section 4b.250. In addition, the following shall apply.

(a) **Buoyancy.** Each seaplane main float shall have a buoyancy of 80 percent in excess of that required to support the maximum weight of the seaplane in fresh water.

(b) **Compartmentation.** Each seaplane main float shall contain not less than 5 watertight compartments. The compartments shall have approximately equal volumes.

**4b.342 Boat hulls.**

(a) The hulls of boat seaplanes and amphibians shall be divided into watertight compartments so that, with any two adjacent compartments flooded, the buoyancy of the hull and auxiliary floats (and wheel tires, if used) will provide a sufficient margin of positive stability to minimize capsizing in rough fresh water.

(b) For the purpose of communication between compartments, bulkheads with watertight doors shall be allowed.

### Personnel and Cargo Accommodations

**4b.350 Pilot compartment; general.** All references to flight crew in this section and sections 4b.351 through 4b.353 shall mean the

minimum flight crew established in accordance with section 4b.720.

(a) The arrangement of the pilot compartment and its appurtenances shall provide safety and assurance that the flight crew will be able to perform all of their duties and operate the controls in the correct manner without unreasonable concentration and fatigue.

(b) The primary flight controls listed on figure 4b-16, excluding cables and control rods, shall be so located with respect to the propellers that no portion of the flight crew or the controls lies in the region between the plane of rotation of any inboard propeller and the surface generated by a line passing through the center of the propeller hub and making an angle of 5° forward or aft of the plane of rotation of the propeller.

(c) When provision is made for a second pilot, the airplane shall be controllable with equal safety from both seats.

(d) The pilot compartment shall be constructed to prevent leakage likely to be distracting to the crew or harmful to the structure when flying in rain or snow.

(e) A door shall be provided between the pilot compartment and the passenger compartment.

(f) The door prescribed in paragraph (e) of this section shall be equipped with a locking means to prevent passengers from opening the door without the pilot's permission.

(g) Vibration and noise characteristics of cockpit appurtenances shall not interfere with the safe operation of the airplane.

4b.350-1 *Noise and vibration characteristics (FAA policies which apply to sec. 4b.350 (g)).* Noise and vibration characteristics should be observed throughout the flight test program. If possible, noise levels should be measured and recorded in decibels.

(19 F. R. 4463, July 20, 1954, effective Sept. 1, 1954.)

#### 4b.351 *Pilot compartment vision.*

##### (a) *Nonprecipitation conditions.*

(1) The pilot compartment shall be arranged to afford the pilots a sufficiently extensive, clear, and undistorted view to perform safely all maneuvers within the operating limitations of the airplane, including taxiing, takeoff, approach, and landing.

(2) It shall be demonstrated by day and night flight tests that the pilot compartment is free of glare and reflections which would tend to interfere with the flight crew's normal duties.

##### (b) *Precipitation conditions.*

(1) Means shall be provided for maintaining a sufficient portion of the windshield clear so that both pilots are afforded a sufficiently extensive view along the flight path in all normal flight attitudes of the airplane. Such means shall be designed to function under the following conditions without continuous attention on the part of the crew:

(i) In heavy rain at speeds up to 1.6  $V_{s1}$ , flaps retracted,

(ii) In the most severe icing conditions for which approval of the airplane is desired.

(2) In addition to the means prescribed in subparagraph (1) of this paragraph at least the first pilot shall be provided with a window which, when the cabin is not pressurized, is openable under the conditions prescribed in subparagraph (1) of this paragraph, and which provides the view specified in that subparagraph. The design shall be such that when the window is opened sufficient protection from the elements will be provided against the impairment of the pilot's vision.

4b.351-1 *Procedure for demonstrating pilot compartment visibility (FAA policies which apply to sec. 4b.351).*

(a) *Nonprecipitation conditions.* Such tests as are deemed necessary to show compliance with section 4b.351 (a) should be conducted.

(b) *Precipitation conditions, section 4b.351 (b).*

(1) The operation of the windshield wiper should be checked in actual or simulated precipitation conditions in order to demonstrate that adequate vision is provided for takeoff and landing at speeds up to 1.6  $V_{s1}$ .

(2) The windshield deicing system should be checked for distribution and operation.

(19 F. R. 4463, July 20, 1954, effective Sept. 1, 1954.)

4b.351-2 *Vision with reverse thrust (FAA policies which apply to sec. 4b.351).* The policies outlined in section 4b.402-1 (g) and (h) will apply.

(20 F. R. 2279, Apr. 8, 1955, effective Apr. 30, 1955.)

4b.351-3 *Minimum area of visibility in the flight crew compartment (FAA policies which*

apply to sec. 4b.351 (a)). The area of visibility established in this section for the pilot, and an equivalent area for the copilot, should be the minimum for showing compliance with the visibility provisions of section 4b.351 (a).

(a) *Reference eye position.* A single point established in accordance with the provisions of this paragraph constitutes the reference eye position (i. e., a point midway between the two eyes) from which the central axis may be located. The reference eye position is located 5 inches aft of the rearmost extremity of the elevator control device when the control is in its most rearward position (i. e., against the up elevator control stops), see figure 6, and 30.5 inches  $\pm$  .5 inch above the point of maximum depression of the seat cushion with:

(1) The pilot seat in a normal operating position from which all controls can be utilized to their full travel, by an average subject, and which will provide for vertical adjustment of the seat of not less than 2½ inches above and 2½ inches below this initial vertical position.

(2) The seat back in its most upright position.

(3) The seat cushion depression being that caused by a subject weighing 170 to 200 pounds.

(4) The longitudinal axis of the airplane level.

(5) The point established not beyond one inch to the left or right of the longitudinal center line of the pilot's seat. (See fig. 6.)

(6) All measurements made from a single point established in accordance with this paragraph.

(b) *Clear areas of vision.*

(1) With the reference eye position located as indicated in paragraph (a) of this section, and utilizing binocular vision and azimuthal movement of the head and eyes about a radius, the center of which is 3½ inches behind the reference eye position (this point to be known as the central axis), the pilot should have the following clear areas of vision measured from the appropriate eye position with the aircraft's longitudinal axis level. The areas defined are based on the cardinal points of reference listed below and indicated in figure 7. A dual lens camera as photo recorder should be used in measuring the angles specified in this paragraph. Other

methods, including the use of a goniometer, are acceptable if they produce equivalent areas to those obtained with the dual lens camera. When not using a dual lens camera compensation should be made for one-half the distance which exists between the eyes, or 1¼ inches as indicated in figure 9.

(i) 20° forward and up from the horizon between 20° left and 10° right allowed to diminish to 15° up at 30° right (this area unbroken).

(ii) 15° forward and down from the horizon between 20° left and 10° right allowed to diminish to 10° down at 30° right (this area unbroken).

(iii) 40° above horizon between 85° and 95° left.

(iv) 30° below horizon between 85° and 95° left.

(v) 20° up and 15° down from horizon at 135° left.

(2) There should be no obstruction to vision in the area indicated in subparagraph 1 (i) and (ii) of this paragraph and in figure 7. Beyond 20° left the angles indicated in subparagraph 1 (i) and (ii) of this paragraph should remain constant, or increase progressively until they reach the reference angles in subparagraph 1 (iii) and (iv) of this paragraph at 85° and should not be less than indicated in these subdivisions up to the 95° position, at which time they may diminish gradually to the angles shown in subparagraph 1 (v) of this paragraph, and should be governed by the limitations of paragraph (d)(2) of this section. The area beyond 135°, if any, should be as large as possible since the human eye does not present any limitation when the use of perceptive rather than binocular vision is the criterion.

(3) It is possible that in the symmetrical type pilot compartment, there may be an area about the center line of the windshield where the requirements governing pilot and copilot vision areas do not overlap. In this area the angles above and below eye level may diminish due to the increased distance between the appropriate eye position and the windshield, but the windshield dimensions established at the 30° right position, above and below the horizontal plane of the pilot's eye, should be retained. This area should also be governed by the

limitations of paragraph (d) (1) and (2) of this section. No attempt is made to define the angles of vision for the pilot, to the right of 30°, since it is assumed that the required vision for the copilot will govern this area. This area not defined by exact limits is indicated by shading in figure 7.

(c) *Optical properties of windshield.* The windshield should exhibit equivalent optical properties to those covered in MIL-G-8602, dated June 29, 1953, for flat panels, and MIL-G-7767, dated August 14, 1951, for curved panels or any applicable military specifications which may be published subsequent to these specifications. In addition, the optical properties of the windshield should not deteriorate under pressurization loads.

(d) *Impairments to vision.*

(1) Any windshield post should not exceed 2.5 inches total obstruction in projected width on the pilot's eyes when located within a sector of 20° and 60° of azimuth to the left of the pilot's forward vision, when measured with head rotated so that the eyes are perpendicular to a vertical plane passing through the center line of the projected width as indicated in figure 8.

(2) The location of instruments, equipment, or structure should not impair any of the areas of vision established in this section. In addition, cockpit equipment should not obstruct a line of vision from a point two inches above the reference eye position to any point along the upper limit of the forward windshield panels, and similarly, a line of vision from a point two inches below the reference eye position to the lower limit of the forward windshield panels.

(22 F. R. 7359, Sept. 14, 1957, effective Sept. 20, 1957.)

#### **4b.352 Windshield and windows.**

(a) All internal glass panes shall be of a nonsplintering safety type.

(b) The windshield panes which the pilots will be directly behind in the normal conduct of their duties and the supporting structures for such panes shall have sufficient strength to withstand without penetration the impact of a four-pound bird when the velocity of the airplane relative to the bird along the airplane's flight path is equal to the value of  $V_c$  at sea

level selected in accordance with section 4b.210 (b) (4).

(c) Means shall be provided to minimize the danger to the pilots from flying windshield fragments due to bird impact unless it can be shown by analysis or test that the probability of occurrence of a critical fragmentation condition is of a low order. The provisions of this paragraph are intended to apply to all transparent panes in the cockpit section which appear in the front view of the aircraft, are inclined 15 degrees or more to the longitudinal axis of the aircraft, and have any portion located so that fragmentation thereof will constitute a hazard to the pilots.

(d) The design of windshields and windows in pressurized airplanes shall be based on factors peculiar to high altitude operation. (See also sec. 4b.373.) [Strength shall be provided in the windshield and window panels to withstand the maximum cabin pressure differential loads (see section 4b.216(c)(1)) combined with critical aerodynamic pressure and temperature effects, after failure of a single load-carrying element of the windshield or window. It shall be acceptable to assume that after a single failure occurs, which is obvious to the flight crew, the cabin pressure differential will be reduced from the maximum in accordance with appropriate operating limitations enabling continued safe flight of the airplane with a cabin pressure altitude of not more than 15,000 feet. (See sec. 4b.374(b).)]

NOTE: Factors peculiar to high altitude operation as they may affect the design of windshields and windows include the effects of continuous and cyclic pressurization loadings, the inherent characteristics of the material used, the effects of temperatures and temperature differentials, etc.

[Amendment 4b-12, published 27 F.R. 2986, Mar. 30, 1962, effective May 3, 1962.]

#### **4b.353 Controls.**

(a) All cockpit controls shall be located to provide convenience in operation and in a manner tending to prevent confusion and inadvertent operation. (See also sec. 4b.737.)

(b) The direction of movement of controls shall be according to figures 4b-16 and 4b-17. Wherever practicable the sense of motion involved in the operation of other controls shall correspond with the sense of the effect of the

operation upon the airplane or upon the part operated. All controls of a variable nature employing a rotary motion shall move clockwise from the off position, through an increasing range, to the full on position.

PRIMARY	
Controls	Movement and actuation
Aileron.....	Right (clockwise) for right wing down.
Elevator.....	Rearward for nose up.
Rudder.....	Right pedal forward for nose right.
SECONDARY	
Flaps (or auxiliary lift devices).	Forward for flaps up; rearward for flaps down.
Trim tabs (or equivalent).	Rotate to produce similar rotation of the airplane about an axis parallel to the axis of the control.

Figure 4b-16.—Aerodynamic controls.

Controls	Movement and actuation
Powerplant	
Throttles.....	Forward to increase forward thrust and rearward to increase rearward thrust.
Propellers.....	Forward to increase rpm.
Mixture.....	Forward or upward for rich.
Carburetor air heat.....	Forward or upward for cold.
Supercharger.....	Forward or upward for low blower. In the case of turbo-superchargers, forward, upward, or clockwise to increase pressure.
Auxiliary	
Landing gear.....	Down to extend.

Figure 4b-17.—Powerplant and auxiliary controls.

(c) The controls shall be so located and arranged with respect to the pilots' seats that there exists full and unrestricted movement of each control without interference from either the cockpit structure or the flight crew's clothing when seated with the seat belt fastened. This shall be demonstrated for individuals ranging from 5' 2" to 6' 0" in height.

(d) Identical powerplant controls for each engine shall be located to prevent any misleading impression as to the engine to which they relate.

(e) The wing flap (or auxiliary lift device) and landing gear controls shall comply with the following:

(1) The wing flap control shall be located on top of the pedestal aft of the throttle(s), centrally or to the right of the pedestal centerline and shall be not less than 10 inches aft of the landing gear control.

(2) The landing gear control shall be located forward of the throttles and shall be operable by each of the pilots when seated with seat belts fastened.

(f) The control knobs shall be shaped in accordance with figure 4b-22, and such knobs shall be of the same color, but of a color in contrast with that of not only the other control knobs but also the surrounding cockpit.

NOTE: Figure 4b-22 is not intended to indicate the exact size or proportion of the control knobs.

(g) Where the workload on the flight crew is such as to require a flight engineer (see sec. 4b.720), a flight engineer station shall be provided. The station shall be so located and arranged that the flight crewmembers can perform their functions efficiently and without interfering with each other.

4b.353-1 *Control tests (FAA policies which apply to sec. 4b.353)*: Such tests as are deemed necessary to show compliance with the control movements and locations specified in section 4b.353 should be conducted.

(19 F. R. 4464, July 20, 1954, effective Sept. 1, 1954.)

4b.354 *Instrument arrangement*. (See sec. 4b.611.)

4b.355 *Instrument marking*. (The operational markings, instructions, and placards required for the instruments, controls, etc., are specified in secs. 4b.730 through 4b.738.)

4b.356 *Doors*.

(a) Airplane cabins shall be provided with at least one easily accessible external door.

(b) Means shall be provided for locking each external door and for safeguarding against opening in flight either inadvertently by persons or as a result of mechanical failure. It shall be possible to open external doors from either the inside or the outside even though persons may be crowding against the door from the inside. (Note: It is not the intent to prohibit the use of inward opening doors if sufficient measures



are provided to prevent occupants from crowding against the door to an extent which would interfere with the opening of the door.) The means of opening shall be simple and obvious and shall be so arranged and marked that it can be readily located and operated even in darkness.

(c) Reasonable provisions shall be made to prevent the jamming of any external door as a result of fuselage deformation in a minor crash.

(d) External doors shall be so located that persons using them will not be endangered by the propellers when appropriate operating procedures are employed.

(e) Means shall be provided for a direct visual inspection of the locking mechanism by crewmembers to ascertain whether all external doors for which the initial opening movement is outward, including passenger, crew, service, and cargo doors, are fully locked (see also sec. 4b.362 (e) (5) for emergency exits). In addition, visual means shall be provided to signal to appropriate crewmembers that all normally used external doors are closed and in the fully locked position.

4b.356-1 *External doors (FAA policies which apply to sec. 4b.356)*. The provisions of section 4b.356 should be applied to all cabin and crew compartment external doors usable for entrance or egress. It is not restricted to the main cabin door. Cargo and service doors not suitable for emergency egress need only comply with section 4b.356 (e) and safeguarding against opening in flight as a result of mechanical failure.

(20 F. R. 2279, Apr. 8, 1955, effective Apr. 30, 1955.)

4b.356-2 *Auxiliary latching devices (FAA policies which apply to sec. 4b.356 (b))*.

(a) The use of auxiliary latching devices is permitted. Such devices would include dual locking handles, other types of locking and safetying devices, and two position handles, and where one operation such as pushing or pulling on the handle unlocks the latching mechanism and the second operation of turning the handle unlatches the door for opening. Auxiliary safetying devices should be used only as an additional safety factor and should not

be used as a means of correcting an inadequate design of the primary locking or latching means. The advantages to be gained from the installation of auxiliary or dual safety devices (safety chains and dual handle main locking means) should be weighed against the need to easily and rapidly open the door in case of emergencies so that the overall level of safety is as high as practicable.

(b) All locking or safety means, including safety chains and latches of any kind, should be so positioned and designed that their presence, location and means of operation are obvious to one not familiar with door designs.

(1) The means of fastening safety devices should be sufficiently simple to make removal easy.

(2) Any emergency release mechanism installed to release the safety device should operate with a simple motion and upon the application of relatively small forces.

(3) All locking devices should be readily operable from both inside and outside of the airplane and be appropriately marked both inside and outside.

(c) Auxiliary safety devices meeting the standards of (b) may be fastened in place during the entire flight. It will not be necessary to have such devices unlatched during takeoff and landing. Auxiliary safety devices such as safety chains or bars that do not meet the standards of paragraph (b) of this section may be used provided operating instructions are installed at or near the device and a placard is installed requiring the removal of such devices prior to takeoff and landing.

(20 F. R. 2279, Apr. 8, 1955, effective Apr. 30, 1955.)

4b.356-3 *Power operated external doors (FAA policies which apply to sec. 4b.356 (b))*. Power operated doors should be so designed that the door can be opened by manual means even when power is inactivated. The loss of power should not cause the door to become unlatched.<sup>14</sup>

(20 F. R. 2279, Apr. 8, 1955, effective Apr. 30, 1955.)

<sup>14</sup> Since emergency landings, such as the wheels-up condition, may reasonably result in the severance of electrical wires or rupture of hydraulic and pneumatic lines, the power which may be needed for operation of the doors or exits may be lost. Similarly, it is conceivable that under emergency conditions, the electrical power source may be purposely interrupted to reduce the possibility of fire.

4b.356-4 *Means for safeguarding against inadvertent opening in flight (FAA policies which apply to sec. 4b.356 (b)).* Auxiliary latching devices may be used to reduce the probability of inadvertent opening in flight provided they meet the standards and conditions covered in section 4b.356-2.

(a) It is acceptable to create a limited access zone in front of the door to eliminate the possibility of a passenger using the door handle as a steadying means and thereby inadvertently opening the door. Although providing a restricted zone by means of a barrier may appear to conflict with the requirements of section 4b.362 (g) for an unobstructed passageway to Type I and II emergency exits, it is considered that it would contribute sufficiently to the overall safety of the aircraft occupants to be permitted. This device may be a rope, chain, rigid bar or gate. Such installations should be waist high to provide the maximum benefits for an adult and the end fastenings should be simple to make removal easy. It is not considered acceptable to install full-length auxiliary doors, but waist-high rigid gates would be acceptable provided they open toward the door and will not block the opening of the cabin door in any way. The locking means should be one which could be easily overridden such as a spring-loaded ball type latch.

(b) Flexible gates such as those made from webbing are not acceptable on the basis that persons may become entangled during an emergency egress. The use of a barrier to prevent persons from inadvertently opening the door in flight does not eliminate the need for a safety means to provide for possible malfunctioning of the primary locking mechanism; however, the auxiliary safetying means of section 4b.356-2 may eliminate the need for a restricted zone.

(20 F. R. 2279, Apr. 8, 1955, effective Apr. 30, 1955.)

4b.356-5 *Direct visual inspection (FAA policies which apply to sec. 4b.356 (e)).* The means of complying with section 4b.356 (e) will depend upon the type of door and locking mechanism used. It should be determined in all cases that means are provided to ascertain that an unsatisfactory condition does not exist after closing the door. In some instances a

central window for viewing the position of the mechanism may be sufficient while other cases may require one or more windows in the door frame to permit inspection of the bayonet location relative to that portion of the lock in the door frame. The need for and/or the number and location of inspection openings or windows will depend on the type of door and locking mechanism used.

(20 F. R. 2279, Apr. 8, 1955, effective Apr. 30, 1955.)

4b.356-6 *Visual indicating system (FAA policies which apply to sec. 4b.356 (e)).*<sup>15</sup>

(a) The visual indicating system may consist of an indicator for each individual door, or a system connecting all doors in series. If the latter system is used, it need not necessarily show which door is not fully locked.

(b) It is not necessary that more than one crewmember be able to ascertain by a visual signal that all external doors, normally used by the crew in supplying the airplane, or in loading and unloading passengers and cargo, are fully closed and locked. The visual signal should be located so that it may easily be seen by the appropriate crewmember from his station.

(20 F. R. 2279, Apr. 8, 1955, effective Apr. 30, 1955.)

**4b.358 Seats, berths, and safety belts.**

(a) *General.* At all stations designated as occupiable during takeoff and landing, the seats, berths, belts, harnesses, and adjacent parts of the airplane shall be such that a person making proper use of these facilities will not suffer serious injury in the emergency landing conditions as a result of inertia forces specified in section 4b.260. Seats and berths shall be of an approved type (see also sec. 4b.643 concerning safety belts).

(b) *Arrangement.*

(1) Passengers and crew shall be afforded protection from head injuries by one of the following means:

(i) Safety belt and shoulder harness which will prevent the head from contacting any injurious object,

<sup>15</sup> The objective herein is to be able to ascertain by visual means that the door and/or locking means is sufficiently engaged to eliminate hazards emanating from an improperly closed door. Outward opening doors present a different problem from inward opening doors.

(ii) Safety belt and the elimination of all injurious objects within striking radius of the head,

(iii) Safety belt and a cushioned rest which will support the arms, shoulders, head, and spine.

(2) For arrangements which do not provide a firm hand hold on seat backs, hand grips or rails shall be provided along aisles to enable passengers or crewmembers to steady themselves while using the aisles in moderately rough air.

(3) All projecting objects which would cause injury to persons seated or moving about the airplane in normal flight shall be padded.

(4) Berths shall be so designed that the forward portion is provided with a padded end board, a canvas diaphragm, or other equivalent means, capable of withstanding the static load reaction of the occupant when subjected to the forward inertia force specified in section 4b.260. Berths shall be free from corners and protuberances likely to cause serious injury to a person occupying the berth during emergency conditions.

(5) Seats for all crewmembers at flight deck stations shall incorporate provisions for the use of a shoulder harness and the seats with such provisions shall comply with the strength requirements of paragraph (c) of this section.

(6) Seats for cabin attendants shall be disposed within the passenger compartment near approved floor level emergency exits. (See sec. 4b.362 (g).)

(c) *Strength.* All seats and berths and their supporting structure shall be designed for occupant weight of 170 pounds with due account taken of the maximum load factors, inertia forces, and reactions between occupant, seat, and safety belt or harness corresponding with all relevant flight and ground load conditions, including the emergency landing conditions prescribed in section 4b.260. In the case of berths, the forward inertia force shall be considered in accordance with paragraph (b) (4) of this section and need not be considered with respect to the safety belt. In addition, the following shall apply.

(1) Pilot seats shall be designed for the reactions resulting from the application of pilot

forces to the flight controls as prescribed in section 4b.224.

(2) In determining the strength of the seat or berth attachments to the structure, and the safety belt or shoulder harness attachments to the seat, berth, or structure, the inertia forces specified in section 4b.260 (a) shall be multiplied by a factor of 1.33 [in lieu of the fitting factor prescribed in section 4b.307(c).]

[(Amendment 4b-12, published 27 F. R. 2986, Mar. 30, 1962, effective May 3, 1962.)]

4b.358-1 *Application of loads (FAA policies which apply to sec. 4b.358).* The actual forces acting on seats, berths, and supporting structure in the various flight, ground, and emergency landing conditions will consist of many possible combinations of forward, sideward, downward, upward, and aft loads. However, in order to simplify the structural analysis and testing of these structures, it will be permissible to assume that the critical load in each of these directions, as determined from the prescribed flight, ground, and emergency landing conditions, acts separately. If the applicant desires, selected combinations of loads may be used, provided the required strength in all specified directions is substantiated. (TSO C-25, Aircraft Seats and Berths, outlines acceptable methods for testing seats and berths.)

(18 F. R. 5563, Sept. 17, 1953, effective Sept. 30, 1953.)

4b.359 *Cargo and baggage compartments.* (See also secs. 4b.382 to 4b.384.)

(a) Each cargo and baggage compartment shall be designed for the placarded maximum weight of contents and the critical load distributions at the appropriate maximum load factors corresponding with all specified flight and ground load conditions, excluding the emergency landing conditions of section 4b.260.

(b) Provisions shall be made to prevent the contents in the compartments from becoming a hazard by shifting under the loads specified in paragraph (a) of this section.

(c) Provisions shall be made to protect the passengers and crew from injury by the contents of any compartment, taking into account the emergency landing conditions of section 4b.260.

## Emergency Provisions

**4b.360 General.** The requirements of sections 4b.361 and 4b.362 shall apply to the emergency provisions.

**4b.361 Ditching.** Compliance with this section is optional. The requirements of this section are intended to safeguard the occupants in the event of an emergency landing during overwater flight. When compliance is shown with the provisions of paragraphs (a) through (c) of this section and with the provisions of sections 4b.362 (d), 4b.645, and 4b.646, the type certificate shall include certification to that effect. When an airplane is certificated to include ditching provisions, the recommended ditching procedures established on the basis of these requirements shall be set forth in the Airplane Flight Manual (see sec. 4b.742 (d)).

(a) All practicable design measures compatible with the general characteristics of the type airplane shall be taken to minimize the chance of any behavior of the airplane in an emergency landing on water which would be likely to cause immediate injury to the occupants or to make it impossible for them to escape from the airplane. The probable behavior of the airplane in a water landing shall be investigated by model tests or by comparison with airplanes of similar configuration for which the ditching characteristics are known. In this investigation account shall be taken of scoops, flaps, projections, and all other factors likely to affect the hydrodynamic characteristics of the actual airplane.

(b) It shall be shown that under reasonably probable water conditions the flotation time and trim of the airplane will permit all occupants to leave the airplane and to occupy the life rafts required by section 4b.645. If compliance with this provision is shown by buoyancy and trim computations, appropriate allowances shall be made for probable structural damage and leakage.

**NOTE:** In the case of fuel tanks which are equipped with fuel jettisoning provisions and which can be reasonably expected to withstand a ditching without leakage, the jettisonable volume of fuel may be considered as buoyancy volume.

(c) External doors and windows shall be designed to withstand the probable maximum

local pressures, unless the effects of the collapse of such parts are taken into account in the investigation of the probable behavior of the airplane in a water landing as prescribed in paragraphs (a) and (b) of this section.

**4b.362 Emergency evacuation.** Crew and passenger areas shall be provided with emergency evacuation means to permit rapid egress in the event of crash landings, whether with the landing gear extended or retracted, taking into account the possibility of the airplane being on fire. If the airplane is divided into separate compartments arranged so that the minimum unobstructed passageway between such compartments is not available as required by paragraph (g) of this section, requirements of this section shall be applied to each compartment independently. Passenger and crew entrances and service doors shall be considered as emergency exits if they meet the applicable requirements of this section.

(a) *Flight crew emergency exits.* Flight crew emergency exits shall be located in the flight crew area, one on each side of the airplane, or, alternatively, a top hatch shall be provided. Such exits shall be of sufficient size and shall be so located as to permit rapid evacuation by the crew. Such exits shall not be required in airplanes having a passenger capacity of 20 or less if the Administrator finds that the proximity of passenger emergency exits to the flight crew area offers a convenient and readily accessible means of evacuation for the flight crew.

(b) *Passenger emergency exits; type and location.* All required exits shall be in such specific locations as will afford the most effective means of passenger evacuation. The type of exits and their general location shall be as follows:

(1) **Type I:** A rectangular opening of not less than 24 inches wide by 48 inches high, with corner radii not greater than  $\frac{1}{8}$  the width of the exit. The first Type I exit on each side of the fuselage shall be located on the aft portion of the passenger compartment unless the configuration of the airplane is such that some other location would afford a more effective

means of passenger evacuation. All Type I exits shall be floor level exits.

(2) Type II: A rectangular opening of not less than 20 inches wide by 44 inches high, with corner radii not greater than  $\frac{1}{8}$  the width of the exit. Unless Type I exits are required, one Type II exit on each side of the fuselage shall be located in the aft portion of the passenger compartment except where the configuration of the airplane is such that some other location would afford a more effective means of passenger evacuation. Type II exits shall be floor level exits unless located over the wing in which case they shall have a step-up inside the airplane of not more than 10 inches and a step-down outside the airplane of not more than 17 inches.

(3) Type III: A rectangular opening of not less than 20 inches wide by 36 inches high, with corner radii not greater than  $\frac{1}{8}$  the width of the exit, located over the wing with a step-up inside the airplane of not more than 20 inches and a step-down outside the airplane of not more than 27 inches.

(4) Type IV: A rectangular opening of not less than 19 inches wide by 26 inches high, with corner radii not greater than  $\frac{1}{8}$  the width of the exit, located over the wing with a step-up inside the airplane of not more than 29 inches and a step-down outside the airplane of not more than 36 inches.

**NOTE:** Larger openings than those specified in paragraph (b) of this section shall be acceptable, whether or not of rectangular shape, provided that the specified rectangular openings can be inscribed therein, and provided further that the base of the inscribed rectangular opening meets the specified step-up and step-down heights.

(c) *Passenger emergency exits; number required.* Emergency exits of the type and location prescribed in paragraph (b) of this section shall be accessible to the passengers and shall be provided in accordance with subparagraphs (1) through (5) of this paragraph.

(1) The relation between the passenger seating capacity and the type and number of exits provided on each side of the airplane shall be as follows:

Passenger seating capacity	Emergency exits required on each side of the fuselage			
	Type I	Type II	Type III	Type IV
1 to 10 inclusive.....				1
11 to 19 inclusive.....			1	
20 to 39 inclusive.....		1		1
40 to 59 inclusive.....	1			1
60 to 79 inclusive.....	1		1	
80 to 109 inclusive.....	1		1	1
110 to 139 inclusive.....	2		1	
140 to 179 inclusive.....	2		2	
180 to 219 inclusive.....	2	2		

**NOTE:** Although similar exits and their locations are prescribed for each side of the fuselage, it is not the intent of this regulation to require that the exits necessarily be at locations diametrically opposite each other.

(2) Additional exits shall be provided on airplanes having 220 or more passengers. The additional exits shall provide an effective means of passenger evacuation consistent with the minima provided in the table in subparagraph (1) of this paragraph.

(3) In applying subparagraph (1) of this paragraph, it shall be acceptable to install 2 Type IV exits in lieu of each required Type III exit.

(4) If the Administrator finds that there exist compensating factors in the emergency evacuation means provided, it shall be permissible to increase the passenger seating capacity beyond that shown in subparagraph (1) of this paragraph, except that such increase in seating capacity shall in no case exceed 10 passengers.

(5) On airplanes where the vertical location of the wing does not permit the installation of over-wing exits, an exit the dimensions of which are not less than those prescribed in paragraph (b) (3) of this section shall be installed for each Type III and each Type IV exit required by subparagraph (1) of this paragraph.

(d) *Ditching emergency exits.* Except as otherwise provided in this paragraph, at least 2 exits, one on each side of the airplane, meeting the minimum dimensions of the exits specified in paragraph (b) (3) of this section and located above the water level, shall be provided.

On airplanes with a passenger seating capacity of 10 or less, the minimum dimensions of the exit specified in paragraph (b)(4) of this section shall be acceptable. In addition, it shall be shown that there is not less than one emergency exit located above the water level for every 35 passengers. It shall be permissible to substitute 2 type IV exits for each required type III exit. When the configuration of the airplane is such that it will not permit the location of side exits above the water level, the required number of side exits shall be replaced by an equal number of overhead hatches of not less than the dimensions of exits specified in paragraph (b) (3) of this section, except that on airplanes having a passenger capacity of 35 or less only one such overhead hatch need be provided.

(e) *Emergency exit arrangement.*

(1) Emergency exits shall consist of movable doors or hatches in the external walls of the fuselage and shall provide an unobstructed opening to the outside.

(2) All emergency exits shall be openable from the inside and from the outside except that sliding window emergency exits in the flight crew area need not be openable from the outside if the Administrator finds that the proximity of other approved exits makes them convenient and readily accessible to the flight crew area.

(3) The means of opening emergency exits shall be simple and obvious and shall not require exceptional effort of a person opening them.

(4) Means shall be provided for locking each emergency exit and for safeguarding against opening in flight either inadvertently by persons or as a result of mechanical failure.

(5) Means shall be provided for a direct visual inspection of the locking mechanism by crewmembers to ascertain whether all emergency exits for which the initial opening movement is outward are fully locked.

(6) Provision shall be made to minimize the possibility of jamming of emergency exits as a result of fuselage deformation in a minor crash landing.

(7) For all landplane emergency exits other than exits located over the wing which are more than 6 feet from the ground

with the airplane on the ground and the landing gear extended, approved means shall be provided to assist the occupants in descending to the ground.

(8) The proper functioning of emergency exit installations shall be demonstrated by test.

(f) *Emergency exit marking.*

(1) All passenger emergency exits, their means of access, and their means of opening shall be marked conspicuously. The identity and location of emergency exits shall be recognizable from a distance equal to the width of the cabin. The location of the emergency exit operating handle and the instructions for opening shall be marked on or adjacent to the emergency exit and shall be readable from a distance of 30 inches.

(2) A source or sources of light, with an energy supply independent of the main lighting system, shall be installed to illuminate all passenger emergency exit markings. Such lights shall be designed to function automatically in a crash landing and shall also be operable manually.

(3) All emergency exits which are required to be openable from the outside, and their means of opening shall be marked on the outside of the airplane for guidance of rescue personnel.

(g) *Emergency exit access.* Passageways between individual compartments of the passenger area and passageways leading to Type I and Type II emergency exits (see paragraph (b) of this section) shall be unobstructed and shall be not less than 20 inches wide. Adjacent to emergency exits where assisting means are required by paragraph (e) (7) of this section, there shall be sufficient additional space to allow a crewmember to assist in the evacuation of passengers without reduction in the unobstructed width of the passageway to such exit.

Access shall be provided from the main aisle to all Type III and Type IV exits and such access shall not be obstructed by seats, berths, or other protrusions to an extent which would reduce the effectiveness of the exit, except that minor obstructions shall be permissible if the Administrator finds that compensating factors are present to maintain the effectiveness of the exit. If it is necessary to pass through a doorway to reach any required emergency

exit from any seat in the passenger cabin, the door shall be provided with a means to latch it in the open position. A suitable placard stating that the door is to be latched in the open position during takeoff and landing shall be installed.

[(h) *Width of main aisle.* The main passenger aisle width at any point between seats shall not be less than the values in the following table:

Passenger seating capacity	Minimum main passenger aisle width	
	Less than 25 inches from floor	25 inches and more from floor
	<i>Inches</i>	<i>Inches</i>
10 or less.....	12	18
11 to 19.....	12	20
20 or more.....	15	20

[(Amendment 4b-12, published 27 F. R. 2986 Mar. 30, 1962, effective May 3, 1962.)]

4b.362-1 *Flight crew emergency exits (FAA policies which apply to sec. 4b.362 (a)).*

(a) A flight crew area emergency exit should be a minimum of 19 by 20 inches unobstructed rectangular opening; however, other size and shape minimums will also be acceptable providing a demonstration of exit utility, using typical flight crew personnel, is satisfactorily demonstrated to the Administrator.

(b) The provisions of section 4b.362 (e) (2) through (8) and 4b.362 (f) are also applicable to flight crew emergency exits. When the internal exit "opening means" involves sequence operations, operation of two handles or latches, release of safety catches, etc., such means will be acceptable for flight crew exits when it can be reasonably established that the means will be "simple and obvious" to crewmembers trained in their use.

(23 F. R. 2789, Apr. 26, 1958, effective May 5, 1958.)

4b.362-2 *Step-down distance (FAA interpretations which apply to sec. 4b.362 (b)).* The step-down distances specified in section 4b.362 (b) (2), (3), and (4) mean the actual distances between the bottom of the required openings and a usable foothold which extends

out from the fuselage and is large enough to be effective without searching visually or by feel.

(23 F. R. 2789, Apr. 26, 1958, effective May 5, 1958.)

4b.362-3 *Number of passengers (FAA policies which apply to sec. 4b.362 (c)).*

(a) Cabin attendants are considered part of the crew and are not included in the passenger seating capacity (section 4b.362 (c) (1)).

(b) The following compensatory factor in emergency evacuation means will be acceptable for an increase in the passenger seating capacity beyond the limits specified in section 4b.362 (c) (1).

(1) The installation of an approved inflatable slide at each floor level exit, other than over the wing exits, is acceptable for,

(i) An increase of no more than 5 passengers on airplanes having at least 2 such exits; or

(ii) An increase of no more than 10 passengers on airplanes having at least 4 such exits.

(23 F. R. 2789, Apr. 26, 1958, effective May 5, 1958.)

4b.362-4 *Emergency exit design descent means*<sup>16</sup> (FAA policies which apply to sec. 4b.362 (e) (7)).

(a) The assist device required for crew exits may be a rope or any other device demonstrated to be suitable for the purpose. If a rope is provided, it should be attached to the fuselage structure at or above the upper limit of the exit opening. The rope and attachment should be capable of withstanding a 400-pound static load.

(b) When required by section 4b.362 (e) (7) at floor level passenger exits, the approved means may be an inflatable slide, a noninflatable slide, or any other device approved by FAA as suitable for the purpose. Ropes or ladders will not be approved as descent means for use at floor level passenger exits.

(23 F. R. 2789, Apr. 26, 1958, effective May 5, 1958.)

<sup>16</sup> Consideration should be given to such factors affecting the utility of Type III and Type IV exits as weight, ease of handling, provision of handholds, stowage space, adequacy of instructions, etc. A side hinged or external opening exit would not be as critical from the weight standpoint as one removed inwardly which must be moved an appreciable distance to clear the exit approach.

4b.362-5 *Emergency exit marking (FAA policies which apply to sec. 4b.362 (f)).*

(a) Exits in excess of the number required by the table in section 4b.362 (c) (1), need not be marked as emergency exits, but if so marked, such exits must meet all requirements of section 4b.362 for the particular type.

(b) Emergency exits used solely for emergency evacuation of the aircraft should be marked "Emergency Exit." Emergency exits customarily used in entering or leaving the airplane need only be marked with the word "Exit." In either case, the marking should be in red or in another color which provides adequate contrast where red might be ineffective against the cabin color scheme.

(c) Opening instructions when not on the exit should be immediately beside the exit and no special effort should be required by a person having 20/20 vision to read these instructions. Readability should be evaluated under representative day and emergency night lighting conditions.

(23 F. R. 2790, Apr. 26, 1958, effective May 5, 1958.)

4b.362-6 *Emergency exit access (FAA policies which apply to sec. 4b.362 (g)).*

(a) Attendant seating facilities<sup>17</sup> should not normally result in any reduction in required aisle widths, passageways between compartments, or the minimum 20-inch passageway leading to Types I and II exits. Attendants seating facilities provided with any acceptable means of clearing the passageway immediately is not considered as being an obstruction to these passageways. An acceptable means of demonstrating compliance would be a spring loaded attendant seat which provides automatic retraction when the seat is vacated. Unless the seat is aft facing, the seat should also be equipped with a shoulder harness.

(b) When it is required that there be an area adjacent to an exit to permit a crewmember to assist passengers in the use of escape devices, a 12- by 20-inch area with the long dimension parallel to and clear of the required 20-inch exit

<sup>17</sup> Under such seating arrangements, particular attention should be directed to compliance with section 4b.260 (c) to protect the attendant from incapacitation by aircraft or galley equipment.

approach passageway or equivalent facility should be provided. The area should be adequate to permit an attendant to stand erect and to perform needed assist services in the evacuation of passengers.

(c) Projection of the seat backs into the minimum required exit opening may be permitted only if the seat back can be pushed forward or aft to clear the opening with the seat occupied. The force required to push the seat back away from the opening should be as low as practicable and should not exceed a maximum of 35 pounds with the seat unoccupied. The action should not require operation of any mechanical release. A clear opening should permit the required minimum exit shape to be projected inward past the seat bottom and back cushion. Minor protrusion of the seat upholstery is acceptable if it does not interfere with exit removal and if it could be compressed without special effort by the person(s) using the exit.

(d) Armrests, curtains, or other protuberances should not restrict the required minimum opening unless they are removed simultaneously with opening of the exit.

(e) Berth installations, whether or not made up, should not decrease the accessibility and utility of emergency exits.

(23 F. R. 2790, Apr. 26, 1958, effective May 5, 1958.)

4b.362-7 *Width of main aisle (FAA policies which apply to sec. 4b.362 (h)).* In determining compliance with aisle width requirements in an airplane so arranged that passengers face the aisle, the minimum aisle should be considered to begin at a point 12 inches forward of the leading edge of each seat.

(23 F. R. 2790, Apr. 26, 1958, effective May 5, 1958.)

### Ventilation, Heating, and Pressurization

**4b.370 General.** The requirements of sections 4b.371 through 4b.376 shall apply to the ventilation, heating, and pressurization of the aircraft.

#### 4b.371 Ventilation.

(a) All crew compartments shall be ventilated by providing a sufficient amount of fresh air to enable the crewmembers to perform



their duties without undue discomfort or fatigue.

NOTE: An outside air supply of approximately 10 cubic feet per minute is considered a minimum for each crewmember.

(b) Ventilating air in crew and passenger compartments shall be free of harmful or hazardous concentrations of gases or vapors.

NOTE: Carbon monoxide concentrations in excess of one part in 20,000 parts of air are considered hazardous. Carbon dioxide in excess of 3 percent by volume (sea level equivalent) is considered hazardous in the case of crewmembers. Higher concentrations of carbon dioxide may not necessarily be hazardous in crew compartments if appropriate protective breathing equipment is available.

(c) Provision shall be made to insure the conditions prescribed in paragraph (b) of this section in the event of reasonably probable failures or malfunctioning of the ventilating, heating, pressurization, or other systems and equipment. If accumulation of hazardous quantities of smoke in the cockpit area is reasonably probable, smoke evacuation shall be readily accomplished starting with full pressurization and without depressurizing beyond safe limits (see sec. 4b.374 (b)).

NOTE: Examples of acceptable provisions include secondary isolation, integral protective devices, and crew warning and shutoff for equipment the malfunctioning of which could introduce harmful or hazardous quantities of smoke or gases.

(d) [Deleted.]

(e) Means shall be provided to enable the crew to control the temperature and quantity of ventilating air supplied to the crew compartment independently of the temperature and quantity of ventilating air supplied to other compartments.

[(Amendment 4b-12, published 27 F. R. 2986, Mar. 30, 1962, effective May 3, 1962.)]

4b.371-1 *Carbon monoxide detection (FAA policies which apply to sec. 4b.371).* Policies outlined in section 4b.467-1 will apply.

(19 F. R. 4463, July 20, 1954, effective Sept. 1, 1954.)

4b.372 *Heating systems.* Combustion heaters shall be of an approved type and shall comply with the fire protection requirements of section 4b.386. Engine exhaust heaters shall comply with the provisions of section 4b.467 (c) and (d).

4b.372-1 *Combustion heaters equipped with carbon dioxide fire extinguishers (FAA policies which apply to sec. 4b.372).* The policies as outlined in section 4b.484-1 apply.

(19 F. R. 4463, July 20, 1954, effective Sept. 1, 1954.)

4b.373 *Pressurized cabins; general.* The design of pressurized cabins shall comply with the requirements of sections 4b.374 through 4b.376. (See also secs. 4b.216 (c) and 4b.352, and the oxygen requirements of the appropriate operating parts of the Civil Air Regulations.)

4b.374 *Pressure equipment and supply.* (See sec. 4b.477 (c).)

(a) Occupied cabins or compartments of airplanes shall be equipped to provide a cabin pressure altitude of not more than 8,000 feet at the maximum operating altitude of the airplane under normal operating conditions.

(b) Airplanes certificated for operation at altitudes over 25,000 feet shall be capable of maintaining a cabin pressure altitude of not more than 15,000 feet in the event of any reasonably probable failure or malfunction in the pressurization system.

4b.375 *Pressure control.* Pressurized cabins shall be provided with at least the following valves, controls, and indicators for controlling cabin pressure.

(a) Two pressure relief valves, at least one of which is the normal regulating valve, shall be installed to limit automatically the positive pressure differential to a predetermined value at the maximum rate of flow delivered by the pressure source. The combined capacity of the relief valves shall be such that the failure of any one valve would not cause an appreciable rise in the pressure differential. The pressure differential shall be considered positive when the internal pressure is greater than the external.

(b) Two reverse pressure differential relief valves (or equivalent) shall be installed to prevent automatically a negative pressure differential which would damage the structure, except that one such valve shall be considered sufficient if it is of a design which reasonably precludes its malfunctioning.

(c) Means shall be provided by which the pressure differential can be rapidly equalized.

(d) An automatic or manual regulator for controlling the intake and/or exhaust air flow

shall be installed so that the required internal pressures and air flow rates can be maintained.

(e) Instruments shall be provided at the pilot or flight engineer station showing the pressure differential, the absolute pressure in the cabin, and the rate of change of the absolute pressure.

(f) Warning indication shall be provided at the pilot or flight engineer station to indicate when the safe or preset limits on pressure differential and on absolute cabin pressure are exceeded.

(g) If the structure is not designed for pressure differentials up to the maximum relief valve setting in combination with landing loads (see sec. 4b.216 (c)), a warning placard shall be placed at the pilot or flight engineer station.

4b.375-1 *Warning indication (FAA policies which apply to sec. 4b.375 (f)).*

(a) *Cabin pressure differential warning.* Because of the protection provided by the required duplication of pressure relief valves, appropriate warning markings on the cabin pressure differential indicator will meet the requirement for a warning indication to the pilot or flight engineer when the safe or preset cabin pressure differential limits are exceeded.

(b) *Cabin absolute pressure warning.* An aural or visual signal in addition to cabin altitude indicating means will meet the requirements for a warning indication to the pilot or flight engineer when the cabin absolute pressure is reduced below that equivalent to 10,000 feet.

(23 F. R. 2790, Apr. 26, 1958, effective May 5, 1958.)

#### 4b.376 Tests.

(a) *Strength test.* The complete pressurized cabin, including doors, windows, and all valves, shall be tested as a pressure vessel for the pressure differential specified in section 4b.216 (c) (3).

(b) *Functional tests.* The following functional tests shall be performed.

(1) To simulate the condition of regulator valves closed, the functioning and the capacity shall be tested of the positive and negative pressure differential valves and of the emergency release valve.

(2) All parts of the pressurization system shall be tested to show proper functioning under

all possible conditions of pressure, temperature, and moisture up to the maximum altitude selected for certification.

(3) Flight tests shall be conducted to demonstrate the performance of the pressure supply, pressure and flow regulators, indicators, and warning signals in steady and stepped climbs and descents at rates corresponding with the maximum attainable without exceeding the operating limitations of the airplane up to the maximum altitudes elected for certification.

(4) All doors and emergency exits shall be tested to ascertain that they operate properly after being subjected to the flight tests prescribed in subparagraph (3) of this paragraph.

### Fire Protection

4b.380 *General.* Compliance shall be shown with the fire protection requirements of sections 4b.381 through 4b.386. (See also secs. 4b.480 through 4b.490.) In addition, the following shall apply.

(a) *Hand fire extinguishers.* Hand fire extinguishers shall be of an approved type. The types and quantities of extinguishing agents shall be appropriate for the types of fires likely to occur in the compartments where the extinguishers are intended for use. Extinguishers intended for use in personnel compartments shall be such as to minimize the hazard of toxic gas concentrations.

(b) *Built-in fire extinguishers.* Where a built-in fire-extinguishing system is required, its capacity in relation to the compartment volume and ventilation rate shall be sufficient to combat any fire likely to occur in the compartment. All built-in fire extinguishing systems shall be so installed that any extinguisher agent likely to enter personnel compartments will not be hazardous to the occupants and that discharge of the extinguisher cannot result in structural damage. (See also sec. 4b.371.)

(c) *Protective breathing equipment.* If the airplane contains Class A, B, or E cargo compartments (see sec. 4b.383), protective breathing equipment shall be installed for the use of appropriate crewmembers. (See sec. 4b.651 (h).)

4b.380-1 *Protective breathing equipment* (FAA policies which apply to sec. 4b.380 (c)). The policies outlined in section 4b.651-2 apply.

(19 F. R. 4463, July 20, 1954, effective Sept. 1, 1954.)

4b.380-2 *Approved hand fire extinguishers* (FAA policies which apply to sec. 4b.380 (a)).

(a) *Standards for approval.* An approved type fire extinguisher includes those approved by the Underwriters' Laboratories, Inc., Factory Mutual Laboratories, Underwriters' Laboratories of Canada, or any other agency deemed qualified by the Administrator, or approved by the Administrator in accordance with the provisions of section 4b.18.

(b) *General.* When selecting a hand fire extinguisher for use in aircraft, consideration should be given to the most appropriate extinguishing agent for the type and location of fires<sup>18</sup> likely to be encountered. Consideration should also be given to the agent's ratio of extinguishing ability to quantity required, toxicity,<sup>19</sup> corrosive properties, freezing point, and to the unit's gross weight, ease of operation, and maintenance requirements. Aircraft hand fire extinguishers using agents having a rating in toxicity Group 4 or under should not be installed in airplanes for which an application for a type certificate was made on or after March 5, 1952.<sup>20</sup>

(c) *Types of extinguishers.*

(1) *Carbon dioxide extinguishers.*<sup>21</sup> Carbon dioxide extinguishers are acceptable when the

<sup>18</sup> *Class A fires*—Fires in ordinary combustible materials where the quenching and cooling effects of quantities of water, or solutions containing large percentages of water, are of first importance.

*Class B fires*—Fires in flammable liquids, greases, etc., where a blanket effect is essential.

*Class C fires*—Fires in electrical equipment, where the use of a nonconducting extinguishing agent is of first importance.

<sup>19</sup> The toxicity ratings listed by the Underwriters' Laboratories for some of the commonly known fire extinguisher chemicals are as follows:

Bromochloromethane.....	Group 3
Bromotrifluoromethane.....	Group 6
Carbon dioxide.....	Group 5
Carbon tetrachloride.....	Group 3
Dibromodifluoromethane.....	Group 4
Methyl bromide.....	Group 2

<sup>20</sup> Many transport type airplanes, due to their type certification basis, are not required to comply with section 4b.380. For such airplanes, it is recommended that hand fire extinguishers employing agents in toxicity Group 4 or higher be installed when renewing or replacing hand fire extinguishers employing toxic agents.

<sup>21</sup> Carbon dioxide is noncorrosive and will not injure food or fabric. Extinguishers must be winterized if they are to operate at temperatures below -40° F. Approved unit capacity ranges upwards from two pounds. These extinguishers have only limited value for the extinguishment of Class A fires, the action of the agent being to blanket the fire by excluding oxygen.

principal hazard is a Class B or Class C fire. Carbon dioxide portable installations should not exceed five pounds of agent per unit to insure extinguisher portability and to minimize crew compartment CO<sub>2</sub> concentrations.

(2) *Water extinguishers.*<sup>22</sup> Water extinguishers are acceptable when the principal hazard is a Class A fire and where a fire might smolder if attacked solely by such agents as carbon dioxide or dry chemical.

(3) *Vaporizing liquid extinguishers.*<sup>23</sup> Vaporizing liquid type fire extinguishers are acceptable when the principal hazard is a Class B or Class C fire.

(4) *Dry chemical extinguishers.*<sup>24</sup> Dry chemical extinguishers are acceptable where the principal hazard is a Class B or Class C fire. The extinguisher should not be used in crew compartments because of interference with visibility during discharge and because of the possibility of the nonconductive powders being discharged on electrical contacts not otherwise involved.

(21 F. R. 5735, Aug. 1, 1956, effective Sept. 1, 1956.)

4b.381 *Cabin interiors.* All compartments occupied or used by the crew or passengers shall comply with the following provisions.

(a) The materials in no case shall be less than flash-resistant.

(b) The wall and ceiling linings, the covering of all upholstering, floors, and furnishings shall be flame-resistant.

(c) Compartments where smoking is to be permitted shall be equipped with ash trays of the self-contained type which are completely removable. All other compartments shall be placarded against smoking.

<sup>22</sup> Certain antifreeze agents may be corrosive. Approved extinguishers are either protected against freezing to -40° F. or must be handled as any other unprotected water on the airplane. Technical Standard Order C19a covers a minimum 1½ quart capacity approved water extinguisher. Water extinguishers of the kinds currently on the market are not acceptable for flammable liquid or electrical fires.

<sup>23</sup> These agents are not normally corrosive to aircraft structure and approved units will be satisfactorily protected against freezing to at least -40° F. Up to the effective date of this policy, no vaporizing liquid extinguisher with Underwriters' Laboratories toxicity rating higher than Group 4 is commercially available. Approved units have a minimum capacity of one quart. They are of only limited value for the extinguishment of Class A fires, having a cooling effect of about one-tenth that of water.

<sup>24</sup> The powder is nontoxic and noncorrosive and approved units are protected against freezing to at least -40° F. Minimum capacity of approved units is two pounds.

(d) All receptacles for used towels, papers, and waste shall be of fire-resistant material, and shall incorporate covers or other provisions for containing possible fires.

(e) At least one hand fire extinguisher shall be provided for use by the flight crew.

(f) In addition to the requirements of paragraph (e) of this section at least the following number of hand fire extinguishers conveniently located for use in passenger compartments shall be provided according to the passenger capacity of the airplane:

Passenger capacity:	<i>Minimum number of fire extinguishers</i>
6 or less.....	0
7 through 30.....	1
31 through 60.....	2
61 or more.....	3

4b.381-1 *Hand fire extinguishers for cabin interiors (FAA policies which apply to sec. 4b.381 (e) and (f)).*

(a) *Crew compartment.* At least one hand fire extinguisher suitable for Class B and C fires should be installed in the crew compartment. Additional extinguishers may be required as dictated by potential fire hazards, extinguisher accessibility, and agent capacity.

(1) The extinguisher(s) should be readily accessible to crewmembers and mounted so as to facilitate quick removal from its mounting bracket.

(b) *Passenger compartments.* Fire extinguisher type and capacity should be based on the hazard, e. g., if a unit must protect large accessible baggage compartments, galleys, or electrical equipment racks, portables larger than minimum size should be provided. The size of the extinguisher should not, however, preclude ready portability by a flight attendant or even a passenger.

(1) Each fire extinguisher should be located adjacent to the most prominent hazard such as a baggage compartment, galley, etc.

(i) Where no such obvious hazard exists, or when only one unit is required, the extinguisher should be located at the flight attendant's station or at the entrance door on aircraft with no flight attendant.

(ii) Where two or more extinguishers are required and location is not dictated by

special hazards, the units should be located at opposite ends of the passenger cabin.

(2) An extinguisher should be installed in each separate cabin, lounge, or smoking compartment unless the extinguisher in the adjacent compartment is in close proximity and easily accessible.

(3) All extinguishers should be easily accessible and clearly visible to the crew and passengers; however, if they cannot be clearly visible, their location should be indicated by a clearly legible placard or sign visible to the crew and passengers.<sup>25</sup>

(21 F. R. 5735, Aug. 1, 1956, effective Sept. 1, 1956.)

#### 4b.382 *Cargo and baggage compartments.*

(a) Cargo and baggage compartments shall include no controls, wiring, lines, equipment, or accessories the damage or failure of which would affect the safe operation of the airplane, unless such items are shielded, isolated, or otherwise protected so that they cannot be damaged by movement of cargo in the compartment, and so that any breakage or failure of such item will not create a fire hazard.

(b) Provision shall be made to prevent cargo or baggage from interfering with the functioning of the fire-protective features of the compartment.

(c) All materials used in the construction of cargo or baggage compartments, including tie-down equipment, shall be flame-resistant.

(d) Sources of heat within the compartment shall be shielded and insulated to prevent igniting the cargo.

Note: Sources of heat likely to ignite cargo include light bulbs, combustion heaters, heater ducts, electrical appliances, etc.

4b.383 *Cargo compartment classification.* All cargo and baggage compartments shall include provisions for safe-guarding against fires according to the following classification.

(a) *Class A.* Cargo and baggage compartments shall be classified as "A" if the presence of a possible fire therein would be easily discernible to a member of the crew while at his station, and if all parts of the compartment are

<sup>25</sup>It is recommended that signs indicating location of extinguishers have letters at least 3/8 inch in height mounted on a contrasting background.

easily accessible in flight. A hand fire extinguisher shall be available for each compartment. (See sec. 4b.380 (c) for protective breathing requirements.)

(b) *Class B.* Cargo and baggage compartments shall be classified as "B" if sufficient access is provided while in flight to enable a member of the crew to reach effectively all parts of the compartment and its contents with a hand fire extinguisher. Compliance shall be shown with the following:

(1) The design of the compartment shall be such that, when the access provisions are being used, no hazardous quantity of smoke, flames, or extinguishing agent will enter any compartment occupied by the crew or passengers. (See sec. 4b.380 (c) for protective breathing requirements.)

(2) Each compartment shall be equipped with a separate system of an approved type smoke detector or fire detector to give warning at the pilot or flight engineer station.

(3) Hand fire extinguishers shall be readily available for use in each compartment.

(4) The compartment shall be completely lined with fire-resistant material.

(c) *Class C.* Cargo and baggage compartments shall be classified as "C" if they do not conform to the prerequisites for the "A" or "B" classifications. Compliance shall be shown with the following:

(1) Each compartment shall be equipped with:

(i) A separate system of an approved type smoke detector or fire detector to give warning at the pilot or flight engineer station, and

(ii) An approved built-in fire-extinguishing system controlled from the pilot or flight engineer station.

(2) Means shall be provided to exclude hazardous quantities of smoke, flames, or extinguishing agent from entering into any compartment occupied by the crew or passengers.

(3) Ventilation and drafts shall be controlled within each compartment so that the extinguishing agent provided can control any fire which may start within the compartment.

(4) The compartment shall be completely lined with fire-resistant material.

(d) *Class D.* Cargo and baggage compartments shall be classified as "D" if they are so designed and constructed that a fire occurring therein will be completely confined without endangering the safety of the airplane or the occupants. Compliance shall be shown with the following:

(1) Means shall be provided to exclude hazardous quantities of smoke, flames, or other noxious gases from entering into any compartment occupied by the crew or passengers.

(2) Ventilation and drafts shall be controlled within each compartment so that any fire likely to occur in the compartment will not progress beyond safe limits.

NOTE: For compartments having a volume not in excess of 500 cu. ft. an airflow of not more than 1,500 cu. ft. per hour is considered acceptable. For larger compartments lesser airflow may be applicable.

(3) The compartment shall be completely lined with fire-resistant material.

(4) Consideration shall be given to the effect of heat within the compartment on adjacent critical parts of the airplane.

(e) *Class E.* On airplanes used for the carriage of cargo only it shall be acceptable to classify the cabin area as a Class "E" compartment. Compliance shall be shown with the following:

(1) The compartment shall be completely lined with fire-resistant material.

(2) The compartment shall be equipped with a separate system of an approved type smoke or fire detector to give warning at the pilot or flight engineer station.

(3) Means shall be provided to shut off the ventilating airflow to or within the compartment. Controls for such means shall be accessible to the flight crew in the crew compartment.

(4) Means shall be provided to exclude hazardous quantities of smoke, flames, or noxious gases from entering the flight crew compartment. (See sec. 4b.380(c) for protective breathing equipment.)

(5) Required crew emergency exits shall remain accessible under all cargo loading conditions.

**4b.384 Proof of compliance.**

(a) Compliance with those provisions of section 4b.383 which refer to compartment accessibility, to the entry of hazardous quantities of smoke or extinguishing agent into compartments occupied by the crew or passengers, and to the dissipation of the extinguishing agent in class C compartments shall be demonstrated by tests in flight.

(b) It shall also be demonstrated during the tests prescribed in paragraph (a) of this section that no inadvertent operation of smoke or fire detectors in adjacent or other compartments within the airplane would occur as a result of fire contained in any one compartment, either during or after extinguishment, unless the extinguishing system floods such compartments simultaneously.

4b.384-1 *Cargo and baggage compartments equipped with carbon dioxide fire extinguishers (FAA policies which apply to sec. 4b.384).* The policies outlined in section 4b.484-1 apply.

(19 F. R. 4463, July 20, 1954, effective Sept. 1, 1954.)

**4b.385 Flammable fluid fire protection.**

In areas of the airplane where flammable fluids or vapors might be liberated by leakage or failure in fluid systems, design precautions shall be made to safeguard against the ignition of such fluids or vapors due to the operation of other equipment, or to control any fire resulting from such ignition.

**4b.386 Combustion heater fire protection.**

(a) *Combustion heater fire zones.* The following shall be considered as combustion heater fire zones and shall be protected against fire in accordance with applicable provisions of sections 4b.480 through 4b.486 and section 4b.489:

(1) Region surrounding the heater, if such region contains any flammable fluid system components other than the heater fuel system which might be damaged by heater malfunctioning or which, in case of leakage or failure, might permit flammable fluids or vapors to reach the heaters.

(2) Region surrounding the heater, if the heater fuel system incorporates fittings the leakage of which would permit fuel or vapors to enter this region.

(3) That portion of the ventilating air passage which surrounds the combustion chamber except that no fire extinguishment need be provided in cabin ventilating air passages.

**(b) Ventilating air ducts.**

(1) Ventilating air ducts which pass through fire zones shall be of fireproof construction.

(2) Unless isolation is provided by the use of fireproof valves or other equivalently effective means, the ventilating air duct downstream of the heater shall be of fireproof construction for a sufficient distance to assure that any fire originating from within the heater can be contained within the duct.

(3) Portions of ventilating ducts passing through regions in the airplane where flammable fluid systems are located shall be so constructed or isolated from such systems that failure or malfunctioning of the flammable fluid system components cannot introduce flammable fluids or vapors into the ventilating airstream.

**(c) Combustion air ducts.**

(1) Combustion air ducts shall be of fireproof construction for a distance sufficient to prevent damage from backfiring or reverse flame propagation.

(2) Combustion air ducts shall not communicate with the ventilating airstream unless it is demonstrated that flames from backfires or reverse burning cannot enter the ventilating airstream under any conditions of ground or flight operation including conditions of reverse flow or malfunctioning of the heater or its associated components.

(3) Combustion air ducts shall not restrict prompt relief of backfires which can cause heater failure due to pressures generated within the heater.

(d) *Heater controls; general.* Provision shall be made to prevent hazardous accumulations of water or ice on or within any heater control components, control system tubing, or safety controls.

**(e) Heater safety controls.**

(1) In addition to the components provided for normal continuous control of air temperature, airflow, and fuel flow, means independent of such components shall be provided with respect to each heater to shut off auto-

matically that heater's ignition and fuel supply at a point remote from the heater when the heat exchanger temperature or ventilating air temperature exceed safe limits or when either the combustion air flow or the ventilating airflow becomes inadequate for safe operation. The means provided for this purpose for any individual heater shall be independent of all components serving other heaters the heat output of which is essential to the safe operation of the airplane.

(2) Warning means shall be provided to indicate to the crew when a heater, the heat output of which is essential to the safe operation of the airplane, has been shut off by the operation of the automatic means prescribed in subparagraph (1) of this paragraph.

(f) *Air intakes.* Combustion and ventilating air intakes shall be so located that no flammable fluids or vapors can enter the heater system under any conditions of ground or flight operation either during normal operation or as a result of malfunctioning, failure, or improper operation of other airplane components.

(g) *Heater exhaust.* Heater exhaust systems shall comply with the provisions of section 4b.467 (a) and (b). In addition, provisions shall be made in the design of the heater exhaust system so that the products of combustion will be safely conveyed overboard to prevent the occurrence of the following:

- (1) Fuel leakage from the exhaust to surrounding compartments;
- (2) Exhaust gas impingement on surrounding equipment or structure;
- (3) Ignition of flammable fluids by the

exhaust, when the exhaust is located in a compartment containing flammable fluid lines;

(4) Restriction by the exhaust of the prompt relief of backfires which can cause heater failure due to pressure generated within the heater.

(h) *Heater fuel systems.* Heater fuel systems shall comply with all portions of the powerplant fuel system requirements which affect safe heater operations. In addition, heater fuel system components within the ventilating airstream shall be protected by shrouds so that leakage from such components cannot enter the ventilating airstream.

(i) *Drains.* Means shall be provided for safe drainage of fuel accumulations which might occur within the combustion chamber or the heat exchanger. Portions of such drains which operate at high temperatures shall be protected in the same manner as heater exhausts (see paragraph (g) of this section). Drains shall be protected against hazardous ice accumulations in flight and during ground operation.

### Miscellaneous

4b.390 *Reinforcement near propellers.* Portions of the airplane near propeller tips shall have sufficient strength and stiffness to withstand the effects of the induced vibration and of ice thrown from the propeller. Windows shall not be located in such regions unless shown capable of withstanding the most severe ice impact likely to occur.

4b.391 *Leveling marks.* Reference marks shall be provided for use in leveling the airplane to facilitate weight and balance determinations on the ground.

## Subpart E—Powerplant

### Installation

4b.400 *General.* The powerplant installation shall be considered to include all components of the airplane which are necessary for its propulsion. It shall also be considered to include all components which affect the control of the major propulsive units or which affect their safety of operation between normal inspections or overhaul periods. (See secs.

4b.604 and 4b.613 for instrument installation and marking.)

(a) *Scope.* Reciprocating engine installations shall comply with the provisions of this subpart. Turbine engine installations shall comply with such of the provisions of this subpart as are found applicable to the specific type of installation.

(b) *Functioning.* All components of the powerplant installation shall be constructed,

arranged, and installed in a manner which will assure their continued safe operation between normal inspections or overhaul periods.

(c) *Accessibility.* Accessibility shall be provided to permit such inspection and maintenance as is necessary to assure continued airworthiness.

(d) *Electrical bonding.* Electrical interconnections shall be provided to prevent the existence of differences of potential between major components of the powerplant installation and other portions of the airplane.

4b.400-1 *Engine and propeller operation (FAA policies which apply to sec. 4b.400).* The engines and propellers should be observed during the flight test program to determine satisfactory operation of these systems and their associated components.

(19 F. R. 4463, July 20, 1954, effective Sept. 1, 1954.)

4b.400-2 *Powerplant installation components (FAA interpretations which apply to sec. 4b.400).* The term "all components" includes engines and propellers and their parts, appurtenances, and accessories which are furnished by the engine or propeller manufacturer and all other components of the powerplant installation which are furnished by the airplane manufacturer. For example: fuel pumps, lines, valves and other components of the fuel system which are integral parts of the type certificated engine are also components of the airplane powerplant installation.

(23 F. R. 9018, Nov. 20, 1958, effective Dec. 22, 1958.)

#### 4b.401 *Engines.*

(a) *Type certification.* All engines shall be type certificated in accordance with the provisions of Part 13 of this subchapter.

(b) *Engine isolation.* The powerplants shall be arranged and isolated each from the other to permit operation in at least one configuration in a manner such that the failure or malfunctioning of any engine, or of any system of the airplane the failure of which can affect an engine, will not prevent the continued safe operation of the remaining engine(s) or require immediate action by a crewmember for continued safe operation.

(c) *Control of engine rotation.* Means shall be provided for individually stopping and

restarting the rotation of any engine in flight, except that for turbine engine installations means for stopping the rotation need be provided only if such rotation could jeopardize the safety of the airplane. All components provided for this purpose which are located on the engine side of the firewall and which might be exposed to fire shall be of fire-resistant construction. If hydraulic propeller feathering systems are used for this purpose, the feathering lines on all airplanes manufactured after June 30, 1954, shall be fire-resistant under the operating conditions which may be expected to exist when feathering is being accomplished. (See also sec. 4b.449.)

(d) *Rotor blade protection.* Turbine powerplant installations shall include a means of protection such that the occurrence of rotor blade failure in any engine will not affect the operation of remaining engines nor jeopardize the continued safe operation of the airplane, unless the engine type certificate specifies that the engine rotor cases have been substantiated as capable of containing the damage resulting from rotor blade failure.

(e) *Engine turbine rotor.* Design precautions shall be taken to minimize the probability of jeopardizing the safety of the airplane in the event of engine turbine rotor failure, unless the engine type certificate specifies that the turbine rotors have been demonstrated to provide sufficient strength to withstand damage inducing factors such as those which might result from abnormal rotor speeds, temperature, or vibration and the design and functioning of the powerplant systems associated with engine control devices, systems, and instrumentation are such as to give reasonable assurance that those engine operating limitations which adversely affect turbine rotor structural integrity will not be exceeded in service.

4b.401-1 *Approval of automatic propeller feathering system (FAA policies which apply to sec. 4b.401 (c)).* All parts of the feathering device which are integral with the propeller or attached to it in a manner that may affect propeller airworthiness should be considered from the standpoint of the applicable provisions of Part 14 of this subchapter. The determination of the continuing eligibility of the propeller



under the existing type certificate, when the device is installed or attached, will be made on the following basis:

(a) The automatic propeller feathering system should not adversely affect normal propeller operation and should function properly under all temperature, altitude, airspeed, vibration, acceleration, and other conditions to be expected in normal ground and flight operation.

(b) The automatic device should be demonstrated to be free from malfunctioning which may cause feathering under any conditions other than those under which it is intended to operate. For example, it should not cause feathering during:

(1) Momentary loss of power.

(2) Approaches with reduced throttle settings.

(c) The automatic propeller feathering system should be capable of operating in its intended manner whenever the throttle control is in the normal position to provide takeoff power. No special operations at the time of engine failure should be necessary on the part of the crew in order to make the automatic feathering system operative.

(d) The automatic propeller feathering installation should be such that not more than one engine will be feathered automatically even if more than one engine fails simultaneously.

(e) The automatic propeller feathering installation should be such that normal operation may be regained after the propeller has begun to feather automatically.

(f) The automatic propeller feathering installation should incorporate a switch or equivalent means by which to make the system inoperative. (See also sec. 4b.10-2.)

(19 F. R. 1818, Apr. 2, 1954, effective Apr. 2, 1954.)

4b.401-2 *Propeller feathering system operational tests (FAA policies which apply to sec. 4b.401 (c)).*

(a) Tests should be conducted to determine the time required for the propeller to change from windmilling (with the propeller controls set for takeoff) to the feathered position at the takeoff safety speed,  $V_2$ .

(b) (1) The propeller feathering system should be tested to demonstrate nonrotation up to 1.2 times the maximum level flight speed with one

engine inoperative or the speed employed in emergency descents whichever is higher with:

Critical engine—inoperative.

Wing flaps—retracted.

Landing gear—retracted.

Cowl flaps—closed.

(2) A sufficient speed range should be covered to assure that the propeller feathering angle established on the basis of the high speed requirement should not permit rotation in reverse at the lower speeds. In addition, the propeller should not inadvertently unfeather during these tests.

(c) In order to demonstrate that the feathering system operates satisfactorily, the propeller should be feathered and unfeathered at the maximum operating altitude established in accordance with section 4b.722. The following data should be recorded:

Time to feather propeller at the one-engine-inoperative cruising speed.

Time to unfeather propeller to 1000 r. p. m. at maximum operating altitude and one-engine-inoperative cruising speed.

Altitude of propeller feathering tests.

Ambient air temperature of propeller feathering tests.

(19 F. R. 4463, July 20, 1954, effective Sept. 1, 1954.)

4b.401-3 *Continued rotation of turbine engines (FAA policies which apply to sec. 4b.401 (c)).*

(a) If means are not provided to completely stop the rotation of turbine engines it should be shown that continued rotation,<sup>26</sup> either windmilling or controlled, of a shutdown turbine engine will not cause:

(1) Powerplant (including engine and accessories) structural damage which will adversely affect other engines or the aircraft structure;

(2) Flammable fluid to be pumped into a fire or onto an ignition source; or

(3) A vibration mode which will adversely affect the aerodynamic or structural integrity of the airplane.

(b) Feathered propellers, brakes, doors or other means used to control turbine engine rotation need not produce a complete stop of engine rotation<sup>26</sup> under all flight conditions

<sup>26</sup> It may be assumed that the conditions in paragraph (a) will not occur at engine rotor speeds up to 400 r.p.m.

unless continued rotation will result in any of the conditions set forth in paragraph (a) of this section.

(c) If engine induction air duct doors, or shaft, or other types of brakes<sup>27</sup> are provided to control engine rotation, no single fault or failure of the system controlling engine rotation should cause the inadvertent travel of the doors toward the closed position, or the inadvertent energizing of braking means, unless compensating features are provided to assure that engine failure or a critical operating condition will not occur.

(22 F. R. 5793, July 20, 1957, effective Aug. 15, 1957.)

**4b.401-4 Engine operation with automatic propeller control system installed (FAA policies which apply to sec. 4b.401 (b)).**

(a) When an automatic control system for simultaneous r. p. m. control of all propellers is installed, it should be shown that no single failure or malfunction in this system or in an engine controlling this system will:

(1) Cause the tolerable engine overspeed for this condition<sup>28</sup> to be exceeded at any time, and

(2) Cause a loss of thrust which will cause the airplane to descend below the established takeoff path (sec. 4b.116) if such system is certificated for use during takeoff and climb. This should be shown for all weights and altitudes for which certification is desired. A period of five seconds should be allowed from the time the malfunction occurs to the initial motion of the cockpit control for corrective action taken by the crew.

(b) Compliance with this policy may be shown by (1) analysis, (2) flight demonstration, or (3) a combination of analysis and flight demonstration.

(22 F. R. 6883, Aug. 27, 1957, effective Sept. 15, 1957.)

**4b.402 Propellers. Propellers shall be type certificated in accordance with the provisions of Part 14 of this subchapter. The maximum propeller shaft rotational speed and the**

<sup>27</sup> The provision of doors or brakes is a protective feature to assure that the conditions of paragraph (a) will not occur. Such provision, therefore, should be of a high order of reliability, and the probability should be remote that doors or brakes will not function normally on demand.

<sup>28</sup> 105 percent of takeoff r. p. m. will be considered tolerable for this condition for all engines, except that higher overspeeds may be acceptable if the engine manufacturer substantiates a higher value to the FAA.

**engine power permissible for use in the airplane shall not exceed the corresponding limits for which the propeller has been certificated.**

**4b.402-1 Reverse thrust propeller installations (FAA policies which apply to sec. 4b.402).** The Administrator may approve reverse thrust propeller installations which comply with the following:

(a) Exceptional pilot skill should not be required in taxiing or any condition in which reverse thrust is to be used.

(b) Necessary operating procedures, operating limitations and placards should be established.

(c) The airplane control characteristics should be satisfactory with regard to control forces encountered, and buffeting should not be likely to cause structural damage.

(d) The directional control should be adequate using normal piloting skill.

(e) It should be determined that no dangerous condition is encountered in the event of sudden failure of one engine in any likely operating condition.

(f) The operating procedures and airplane configuration should be such as to provide reasonable safeguards against serious structural damage to parts of the airplane due to the reverse airflow.

(g) It should be determined that the pilot's vision is not dangerously obscured under normal operating conditions on dusty or wet runways and where light snow is on the runway.

(h) It should be determined that the pilot's vision is not dangerously obscured by spray due to reverse airflow under normal water operating conditions with seaplanes.

(i) The procedure and mechanisms for reversing should provide a reverse idle setting such that without requiring exceptional piloting skill at least the following conditions are met:

(1) Sufficient power is maintained to keep the engine running at an adequate speed to prevent engine stalling during and after the propeller reversing operation.

(2) The propeller does not overspeed during and after the propeller reversing operation.

(3) This idle setting does not exceed 25% of the maximum continuous rating.

(j) The engine cooling characteristics should be satisfactory in any likely operating condition.

(k) The use of reverse thrust will be permitted, in combination with the brakes installed, in establishing the accelerate-stop distance, if it is shown that such use provides a level of safety equivalent to that when wheel brakes alone are used, taking into consideration pilot skill required and the likelihood of attaining the necessary performance under conditions of simulated engine failure. Either of the following conditions and limitations should be used:

(1) Symmetrical reverse thrust on (n-2) engines with power not to exceed the maximum continuous rating, where n is equal to the number of engines.

(2) Asymmetrical reverse thrust on (n-1) engines in reverse idle setting. This operation should be permitted only where it can be shown that with use of this asymmetrical reverse thrust the airplane can be satisfactorily controlled on a wet runway.

(1) On four-engine aircraft the use of reverse thrust will be permitted in combination with the brakes installed in establishing the landing distance if it is shown that such use provides a level of safety equivalent to that when wheel brakes alone are used taking into consideration pilot skill required and the likelihood of attaining the necessary performance under conditions of simulated engine failure. Determination of landing distance should be conducted in accordance with section 4b.122 and section 4b.123 with the following additional provisions:

(1) A steady gliding approach should be made on an ILS flight path corresponding to the average value of  $2\frac{1}{2}$  degrees, except that this prescribed approach will not be required if the application of reverse thrust credit is limited to operations on dry and ice free runways under VFR conditions.

(2) The two most critical symmetrical engines may be placed in the reverse idle position not sooner than four seconds after the aircraft is firmly on the ground.

(3) An accelerated service test should be conducted in accordance with section 4b.16 (b) to establish reliability of the installation which should include not less than 25 landings, covering a range of power settings during the ap-

proach and a range of altitudes for which approval is desired.

(20 F. R. 2279, Apr. 8, 1955, effective Apr. 30, 1955.)

**4b.403 Propeller vibration.** The magnitude of the propeller blade vibration stresses under all normal conditions of operation shall be determined by actual measurement or by comparison with similar installations for which such measurements have been made. The vibration stresses thus determined shall not exceed values which have been demonstrated to be safe for continuous operation.

**4b.404 Propeller pitch and speed limitations.**

(a) The propeller pitch and speed shall be limited to values which will assure safe operation under all normal conditions and which will assure compliance with the performance requirements specified in sections 4b.110 through 4b.125.

(b) A propeller speed limiting means shall be provided at the governor. Such means shall be set to limit the maximum possible governed engine speed to a value not exceeding the maximum permissible r. p. m.

(c) The low pitch blade stop in the propeller, or other means used to limit the low pitch position, shall be set so that the engine speed does not exceed 103 percent of the maximum permissible engine r. p. m. under the following conditions:

(1) Propeller blades at the low pitch limit and governor inoperative, and

(2) Engine operating at takeoff manifold pressure with the airplane stationary under standard atmospheric conditions.

**4b.405 Propeller clearance.** With the airplane loaded to the maximum weight and at the most adverse center of gravity position and the propellers in the most adverse pitch position, the propeller clearances shall not be less than the following, unless smaller clearances are substantiated for the particular design involved.

(a) **Ground.** Seven inches of ground clearance for airplanes equipped with nose-wheel type landing gears, or nine inches of ground clearance for airplanes equipped with tail-wheel type landing gears shall be provided with the landing gear statically deflected and the

airplane in the level take-off or in the taxiing attitude, whichever is most critical. In addition, there shall be positive clearance between the propeller and the ground when, with the airplane in the level takeoff attitude, the critical tire is completely deflated and the corresponding landing gear strut is completely bottomed.

(b) *Water.* A water clearance of 18 inches shall be provided unless compliance with section 4b.182 (a) is demonstrated with less clearance.

(c) *Structure.*

(1) One inch radial clearance shall be provided between the blade tips and the airplane structure, or whatever additional radial clearance is necessary to preclude harmful vibration of the propeller or airplane.

(2) One-half inch longitudinal clearance shall be provided between the propeller blades or cuffs and all stationary portions of the airplane.

(3) Positive clearance shall be provided between other rotating portions of the propeller or spinner and all stationary portions of the airplane.

[CAR, 15 F. R. 3543, June 8, 1950, as amended by Amdt. 4b-7, 17 F. R. 11631, Dec. 20, 1952.]

#### 4b.406 *Propeller deicing provisions.*

(a) Airplanes intended for operation under atmospheric conditions conducive to the formation of ice on propellers or on accessories where ice accumulation would jeopardize engine performance shall be provided with means for the prevention or removal of hazardous ice accumulations.

(b) If combustible fluid is used for propeller deicing, the provisions of sections 4b.480 through 4b.483, inclusive, shall be complied with.

4b.406-1 *Fluid type propeller deicing test (FAA policies which apply to sec. 4b.406).* If the propellers are equipped with fluid type deicers, the flow test should be conducted starting with a full tank of fluid and operated at maximum flow for a 15-minute timed period. The operation should be checked at all engine speeds and powers. The tank should be refilled to determine the amount of fluid used after the airplane is landed.

(19 F. R. 4463, July 20, 1954, effective Sept. 1, 1954.)

#### 4b.407 Reversing systems.

(a) Reversing systems intended for ground operation only shall be such that no single failure or malfunctioning of the system under all anticipated conditions of airplane operation will result in unwanted reverse thrust. Failure of structural elements need not be considered if occurrence of such failure is expected to be extremely remote.

(b) Turbojet reversing systems intended for inflight use shall be such that no unsafe condition will result during normal operations of the system, or from any failure or reasonably likely combination of failures of the reversing system, under all anticipated conditions of operation of the airplane. Failure of structural elements need not be considered if occurrence of such failure is expected to be extremely remote.

4b.407-1 *Investigation of propeller systems which produce negative thrust (FAA policies which apply to sec. 4b.407).*

(a) Compliance with section 4b.407 may be demonstrated by failure analysis, testing, or a combination of both for propeller systems that allow propeller blades to move from the flight low-pitch position to a position<sup>29</sup> that is substantially less than that at the normal flight low-pitch stop position.

(b) The analysis should disclose, for all components involved in the reversing system, the types of failure or malfunction likely to occur, how such failures or malfunctions affect propeller pitch, and the design feature that prevents unwanted travel of the propeller blades to a position substantially below the normal flight low-pitch stop. The analysis may include, or be supported by, the analysis made to demonstrate compliance with the requirements of section 14.103 of this subchapter for the propeller and associated installation components supplied with it.

(c) When necessary, testing should be conducted to verify assumptions made in the analysis of how the propeller will function with a failed system component and that the design

<sup>29</sup> Where the blade position is intended to provide increased drag during the landing run (ground fine pitch) or a reversed propeller blade position.

feature provided does in fact prevent unwanted travel of the propeller blades.

(22 F. R. 6885, Aug. 27, 1957, effective Sept. 15, 1957).

**4b.408 Turbopropeller-drag limiting systems.** For turbopropeller-powered airplanes, propeller-drag limiting systems shall be such that no single failure or malfunction of any of the systems during normal or emergency operation will result in propeller drag in excess of that for which the airplane was designed in compliance with section 4b.216 (d). Failure of structural elements of the drag limiting systems need not be considered if occurrence of such failure is expected to be extremely remote. (See also sec. 4b.310.)

**4b.409 Turbine powerplant operating characteristics.** Turbine powerplant operating characteristics shall be investigated in flight to determine that no adverse characteristics, such as stall, surge, or flameout, are present to a hazardous degree during normal and emergency operation of the airplane within the range of operating limitations of the airplane and of the engine.

### Fuel System Operation and Arrangement

#### 4b.410 General.

(a) The fuel system shall be constructed and arranged in such a manner as to assure a flow of fuel at a rate and pressure which have been established for proper engine functioning under all likely operating conditions, including all maneuvers for which the airplane is intended. (For fuel system instruments see sec. 4b.604.)

(b) The fuel system shall be so arranged that no one fuel pump can draw fuel from more than one tank at a time unless means are provided to prevent introducing air into the system.

**4b.411 Fuel system independence.** The design of the fuel system shall comply with the requirements of section 4b.401 (b). Unless other provisions are made in compliance with this requirement, the fuel system shall be arranged to permit the supply of fuel to each engine through a system independent of any portion of a system supplying fuel to any other engine.

#### 4b.413 Fuel flow.

[(a) The fuel system shall provide not less than 100 percent of the fuel flow required by the engines when the airplane is operated under all intended operating conditions and maneuvers.

[(b) In determining compliance with the provisions of paragraph (a) of this section, the provisions of subparagraphs (1) through (4) of this paragraph shall apply.

[(1) Fuel shall be delivered to the engine at a pressure within the limits specified in the engine type certificate.

[(2) The quantity of fuel in the tank being considered shall not exceed the sum of the amount established as the unusable fuel supply for that tank, as determined in accordance with the provisions of section 4b.416, and whatever minimum quantity of fuel it may be necessary to add for the purpose of determining compliance.

[(3) Such main pumps shall be used as are necessary for each operating condition and airplane attitude for which compliance is determined, and, in addition, for each main pump so used the appropriate emergency pump shall be substituted. (See sec. 4b.430(b).)

[(4) If a fuel flowmeter is provided, operation of the meter shall be blocked in determining compliance with this section and the fuel shall flow through the meter or its bypass.

[(c) If an engine can be supplied with fuel from more than one tank, it shall be possible to regain the full fuel pressure of that engine in not more than 20 seconds after switching to any fuel tank when engine malfunctioning becomes apparent due to the depletion of the fuel supply in any tank from which the engine can be fed.]

[(Amendment 4b-12, published 27 F. R. 2986, Mar. 30, 1962, effective May 3, 1962.)]

**4b.416 Unusable fuel supply.** The unusable fuel supply shall be selected by the applicant and shall be established for each tank as not less than the quantity at which the first evidence of malfunctioning occurs under the most adverse condition from the standpoint of fuel feed during all intended operations and flight maneuvers involving use of that tank.]

[(Amendment 4b-12, published 27 F. R. 2896, Mar. 30, 1962, effective May 3, 1962.)]

**4b.417 Fuel system hot weather operation.**

(a) To prove satisfactory hot weather operation the airplane shall be climbed from the altitude of the airport chosen by the applicant to the altitude corresponding with that at which the one-engine-inoperative best rate of climb is not greater than the en route climb with the configuration and at the weight specified in section 4b.120 (c). There shall be no evidence of vapor lock or other malfunctioning. The climb test shall be conducted under the following conditions:

(1) For reciprocating-engine-powered airplanes, all engines shall operate at maximum continuous power, except that takeoff power shall be used for the altitude range extending from 1,000 feet below the critical altitude through the critical altitude. The time interval during which takeoff power is used shall not be less than the takeoff time limitation. For turbine-engine-powered airplanes, all engines shall operate at takeoff power for the time interval selected by the applicant in demonstrating the takeoff flight path and thereafter shall operate at maximum continuous power for the duration of the climb.

(2) The weight shall be with full fuel tanks, minimum crew, and such ballast as is required to maintain the center of gravity within allowable limits.

(3) The speed of climb shall not exceed that which will permit compliance with the minimum climb requirement specified in section 4b.119 (a).

(4) The fuel temperature shall be not less than 110° F.

(b) The test prescribed in paragraph (a) of this section shall be performed either in flight or on the ground closely simulating flight conditions. If a flight test is performed in weather sufficiently cold to interfere with the proper conduct of the test, the fuel tank surfaces, fuel lines, and other fuel system parts subjected to cooling action from cold air shall be insulated to simulate, in so far as practicable, flight in hot weather.

4b.417-1 *Hot weather fuel system tests (FAA policies which apply to sec. 4b.417).*

(a) *General.* Hot weather fuel system tests should be conducted with fuel in the tanks

normally used for takeoff and landing and with the maximum number of engines drawing fuel from the tank as would normally occur in flight. In the case of symmetrical fuel tank systems, the tests may be confined to one of each such system. Unweathered fuel should be used during these demonstrations. The fuel temperature should be 110° F. just prior to takeoff. If the fuel must be heated to this temperature, caution should be taken to prevent overheating during the process. The auxiliary fuel pumps should be turned "off" or "on" during the tests depending upon the normal operating procedure established for the airplane. If the auxiliary pumps are being considered for use as emergency pumps, they should be inoperative to at least 6,000 feet. A fuel pressure failure is considered to occur when the fuel pressure decreases below the minimum prescribed by the engine manufacturer.

(b) *Configuration.* This test should be conducted in the configuration that follows:

Weight—corresponding to operation with full fuel tanks, minimum crew and ballast required to maintain airplane within center of gravity limits.

C. G. position—optional, within allowable limits.

Wing flaps—most favorable position.

Landing gear—retracted.

Cowl flaps—in a position that provides adequate cooling in the hot day condition.

Engines—See (c).

(c) *Test procedure and required data.* The takeoff and climb should be made as soon as possible after the fuel in the tank has been heated to 110° F. The airspeed during the climb should not exceed that speed used in demonstrating the requirements specified in section 4b.119 (a). If the engines are normally operated with the auxiliary pumps "off," they should be turned "on" when a fuel pressure failure occurs. Restoration of fuel pressure should be noted and the climb continued to the maximum operating altitude selected by the applicant for certification. The following data should be recorded at reasonable time intervals:

Fuel temperature at start of test.

Fuel pressure at start of test and continuously during climb noting any pressure failures.

Auxiliary fuel pump operation.

Pressure altitude.

Ambient air temperature.

Airspeed.

Engines, r. p. m. and manifold pressure.

Comments on engine operation.

(19 F. R. 4463, July 20, 1954, effective Sept. 1, 1954; amended 22 F. R. 6963, Aug. 29, 1957, effective Sept. 15, 1957.)

**[4b.418 Flow between interconnected tanks.** If it is possible to pump fuel from one tank to another in flight, the design of the fuel tank vents and the fuel transfer system shall be such that no structural damage to tanks will occur in the event of overfilling.]

[(Amendment 4b-12, published 27 F. R. 2986, Mar. 30, 1962, effective May 3, 1962.)]

### Fuel System Construction and Installation

#### 4b.420 General.

(a) Fuel tanks shall be capable of withstanding without failure all vibration, inertia, fluid, and structural loads to which they may be subjected in operation.

(b) Flexible fuel tank liners shall be of an approved type or shall be shown to be suitable for the particular application.

(c) Integral type fuel tanks shall be provided with facilities for inspection and repair of the tank interior.

(d) [Deleted.]

(e) Fuel tanks located within the fuselage contour shall be capable of resisting rupture and retaining the fuel under the inertia forces prescribed for the emergency landing conditions in section 4b.260. In addition, these tanks shall be located in a protected position so that exposure of the tanks to scraping action with the ground will be unlikely.

(f) The augmentation liquid tank capacity available for the use of each engine shall be sufficient to permit operation of the airplane in accordance with the procedures for the use of liquid augmented powers which are established and approved with respect to compliance with the related requirements of this part. The computation of liquid consumption shall be

based on the maximum approved rate appropriate for the desired engine output and shall include the effect of temperature on engine performance as well as any other factors that might cause a variation in the amount of liquid required.

[(Amendment 4b-12, published 27 F. R. 2986 Mar. 30, 1962, effective May 3, 1962.)]

4b.420-1 *Minimum quantity of antidetonant fluid required (FAA policies which apply to sec. 4b.420 (e)).*

(a) *Airplanes equipped with a common tank for two engines.* The usable capacity of the tank should be sufficient for operation of the engines served by that tank for a duration equal to that determined by Case A, B, or C, whichever is applicable and results in the greater value (see table 2). The capacity should be based on the flow rate approved during engine type certification.

(1) *Case A.* Case A is intended to provide for conditions with all engines operating and, therefore, the approach climb requirement is not involved.

(2) *Case B.* Case B is intended to provide for failure of one engine during the course of a flight between takeoff and landing and may, therefore, involve the approach climb requirement but not the landing climb requirement.

(3) *Case C.* Case C provides for failure of an engine during the course of a flight between takeoff and landing on a four-engine aircraft which has two tanks; each feeding a pair of engines on one side of the airplane. The tables show the quantities required to assure an adequate supply of fluid on the side of the airplane opposite to the side on which the failure occurs since this is the critical consideration for determining the tank quantity. Both tanks on the airplane should, of course, have this capacity. For the same reason as in Case B, the landing climb is not involved for Case C, but the approach climb requirement may be involved.

(b) *Airplanes equipped with a separate tank for each engine.* The capacity of the tank should be sufficient for operation of the engine for a duration equal to the greatest value specified for engine #1 in the three cases listed in table 2. However, in no case should the

TABLE 2. ANTIDETONANT TANK CAPACITY  
(Total for tank equals sum of totals for both engines served by tank)

	Case A		Case B		Case C	
	Engine #1	Engine #2	Engine #1	Engine #2	Engine #1	Engine #2
Takeoff.....	X <sup>1</sup>	X	X	X	X	X
Approach <sup>2</sup> .....	X	X	X	X	X	X
Landing <sup>3</sup> .....	X/2 <sup>4</sup>	X/2 <sup>4</sup>	X	X	X	X
Reserve.....	X/2 <sup>4</sup>	X/2 <sup>4</sup>	X	X	X	X

<sup>1</sup> Wherever "X" appears in the table, it denotes a duration equal to the maximum time for which the use of wet takeoff power is used for determination of the takeoff flight path of the airplane. However, in no case should the value of either "X" or "X/2" be considered to be less than one minute.

<sup>2</sup> Applies as indicated by "X" only if wet takeoff power is used to demonstrate compliance with the approach climb requirement of section 4b.120 (d).

<sup>3</sup> Applies as indicated by "X" only if wet takeoff power is used to demonstrate compliance with the landing climb requirement of section 4b.119 (b).

<sup>4</sup> "X/2" is specified for the reserve in the all-engine operating case rather than "X" because this type of operation is considered less critical than operation with one engine inoperative and the reserve need not therefore be as large.

quantity be less than that required for three minutes of engine operation.

(20 F. R. 2280, Apr. 8, 1955, effective Apr. 30, 1955.)

#### 4b.421 Fuel tank tests.

(a) Fuel tanks shall be demonstrated by test to be capable of withstanding the more critical of the pressures resulting from the conditions of subparagraphs (1) and (2) of this paragraph without failure or leakage as mounted in the airplane. In addition, tank surfaces subjected to more critical pressures resulting from the conditions of subparagraphs (3) and (4) of this paragraph shall be demonstrated by means of either analyses or tests to be capable of withstanding such pressures.

(1) Internal pressures of 3.5 psi;

(2) 125 percent of the maximum air pressure developed in the tank from ram effect;

(3) Fluid pressures developed during maximum limit accelerations and deflections of the airplane with a full tank;

(4) Fluid pressures developed during the most adverse combination of airplane roll and fuel load.

(b) Metallic tanks with large unsupported or unstiffened flat surfaces, the failure or deformation of which could cause fuel leakage, shall be capable of withstanding a vibration test in accordance with the conditions of subparagraphs (1) through (4) of this paragraph, or other equivalent test, without leakage or excessive deformation of the tank walls.

(1) The complete tank assembly together with its supports shall be subjected to a vibra-

tion test when mounted in a manner simulating the actual installation.

(2) The tank assembly shall be vibrated for 25 hours while filled two-thirds full of water or any suitable test fluid. The amplitude of vibration shall not be less than one thirty-second of an inch, unless otherwise substantiated.

(3) The frequency of vibration shall be 90 percent of the maximum continuous rated speed of the engine unless some other frequency within the normal operating range of speeds of the engine is more critical, in which case the latter speed shall be employed and the time of test shall be adjusted to accomplish the same number of vibration cycles.

(4) During the test, the tank assembly shall be rocked at the rate of 16 to 20 complete cycles per minute through an angle of 15° on either side of the horizontal (30° total) about the most critical-axis for 25 hours. If motion about more than one axis is likely to be critical, the tank shall be rocked about each axis for 12½ hours.

(c) Nonmetallic tanks shall withstand the test specified in subparagraph (b)(4) of this section with fuel at a temperature of 110° F. except that this test shall not be required where satisfactory operating experience with a similar tank in a similar installation is shown. During the test a representative specimen of the tank shall be installed in supporting structure which simulates the installation in the airplane.



**4b.422 Fuel tank installation.**

(a) The method of support for fuel tanks shall not permit concentration of loads, resulting from the weight of the fuel in the tank, on unsupported tank surfaces. The following shall be applicable:

(1) Pads shall be provided to prevent chafing between the tank and its supports.

(2) Materials employed for padding shall be nonabsorbent or shall be treated to prevent the absorption of fluids.

(3) If flexible tank liners are employed they shall be so supported that the liner is not required to withstand fluid loads.

(4) Interior surfaces of tank compartments shall be smooth and free of projections which could cause wear of the liner, unless provisions are made for protection of the liner at such points or unless the construction of the liner itself provides such protection.

(b) Spaces adjacent to the surfaces of the tank shall be ventilated consistent with the size of the compartment to avoid fume accumulation in the case of minor leakage. If the tank is in a sealed compartment it shall be acceptable to limit the ventilation to that provided by drain holes of sufficient size to prevent excessive pressure resulting from altitude changes.

(c) Location of fuel tanks shall comply with the provisions of section 4b.481 (a).

(d) No portion of engine nacelle skin which lies immediately behind a major air egress opening from the engine compartment shall act as the wall of an integral tank.

(e) Fuel tanks shall be isolated from personnel compartments by means of fumeproof and fuelproof enclosures.

**4b.423 Fuel tank expansion space.**

(a) Fuel tanks shall be provided with an expansion space of not less than 2 percent of the tank capacity.

(b) It shall not be possible to fill the fuel tank expansion space inadvertently when the airplane is in the normal ground attitude.

**4b.424 Fuel tank sump.**

(a) Each fuel tank shall be provided with a sump having a capacity of not less than either 0.10 percent of the tank capacity or one-six-

teenth of a gallon, whichever is the greater, except that a smaller capacity shall be acceptable if operating limitations are established to assure that in service the accumulation of water will not exceed the sump capacity.

(b) The fuel tank sump capacity specified in paragraph (a) of this section shall be effective with the airplane in the normal ground attitude. The fuel tank shall be constructed to permit drainage of any hazardous quantity of water from all portions of the tank to the sump when the airplane is in the ground attitude.

(c) Fuel tank sumps shall be provided with an accessible drain to permit complete drainage of the sump on the ground. The drain shall discharge clear of all portions of the airplane and shall be provided with means for positive locking of the drain in the closed position, either manually or automatically.

**4b.425 Fuel tank filler connection.**

(a) The design of fuel tank filler connections shall be such as to prevent the entrance of fuel into the fuel tank compartment or any other portion of the airplane other than the tank itself.

(b) Recessed fuel tank filler connections which retain any appreciable quantity of fuel shall incorporate a drain, and the drain shall discharge clear of all portions of the airplane.

(c) The fuel tank filler cap shall provide a fuel-tight seal.

(d) The fuel tank filler connections shall be marked as prescribed in section 4b.738 (b).

**4b.426 Fuel tank vents and carburetor vapor vents.**

(a) Fuel tanks shall be vented from the top portion of the expansion space in such a manner that venting of the tank is effective under all normal flight conditions. The following shall be applicable:

(1) Vent outlets shall be located and constructed to prevent the possibility of being obstructed by ice or other foreign matter.

(2) The vent shall be constructed to preclude the possibility of siphoning fuel during normal operation.

(3) The vent shall be of sufficient size to prevent the existence of excessive differences of pressure between the interior and exterior

of the tank during normal flight operation, during maximum rate of descent, and, if applicable, during refueling and defueling.

(4) Airspaces of tanks with interconnected outlets shall also be interconnected.

(5) There shall be no points in the vent line where moisture could accumulate with the airplane in either the ground or the level flight attitude unless drainage is provided.

(6) Vents and drainage shall not terminate at points where the discharge of fuel from the vent outlet would constitute a fire hazard or from which fumes could enter personnel compartments.

(b) Carburetors which are provided with vapor elimination connections shall be provided with a vent line to lead vapors back to one of the fuel tanks. The vents shall comply with the following:

(1) Provisions shall be incorporated in the vent system to avoid stoppage by ice.

(2) If more than one fuel tank is provided and it is necessary to use the tanks in a definite sequence, the vapor vent return line shall lead back to the fuel tank used for takeoff and landing.

**4b.427 Fuel tank outlet.** A fuel strainer of 8 to 16 meshes per inch shall be provided either for the fuel tank outlet or for the booster pump. Strainers shall comply with the following:

(a) The clear area of the fuel tank outlet strainer shall not be less than 5 times the area of the fuel tank outlet line.

(b) The diameter of the strainer shall not be less than the diameter of the fuel tank outlet.

(c) Finger strainers shall be accessible for inspection and cleaning.

**4b.428 Under-wing fueling provisions.** Under-wing fuel tank connections shall be provided with means to prevent the escape of hazardous quantities of fuel from the tank in the event of malfunctioning of the fuel entry valve while the cover plate is removed. In addition to the normal means provided in the airplane for limiting the tank content, a means shall be installed to prevent damage to the tank in case of failure of the normal means.

## Fuel System Components

### 4b.430 Fuel pumps.

#### (a) Main pumps.

(1) Any fuel pump that is required for proper engine operation or to meet the fuel system requirements of this subpart, except for the provisions of paragraph (b) of this section, shall be considered a main pump.

(2) Provision shall be made to permit the bypass of all positive displacement fuel pumps except fuel injection pumps approved as part of the engine.

#### (b) Emergency pumps.

(1) Emergency pumps shall be provided and immediately available to permit supplying all engines with fuel in case of failure of any one main fuel pump except fuel injection pumps approved as part of the engine. This requirement is not intended to prohibit the use of another main pump as an emergency pump after failure of one main pump.

4b.430-1 *Fuel injection pump (FAA interpretations which apply to sec. 4b.430).* The phrase "fuel injection pump" means a pump that supplies the proper flow and pressure conditions for fuel injection<sup>30</sup> when such injection is not accomplished in a carburetor.

(23 F. R. 7482, Sept. 26, 1958, effective Oct. 20, 1958.)

### 4b.432 Fuel system lines and fittings.

(a) Fuel lines shall be installed and supported to prevent excessive vibration and to withstand loads due to fuel pressure and due to accelerated flight conditions.

(b) Fuel lines which are connected to components of the airplane between which relative motion could exist shall incorporate provisions for flexibility.

(c) Flexible connections in fuel lines which may be under pressure and subjected to axial loading shall employ flexible hose assemblies rather than hose clamp connections.

(d) Flexible hose shall be of an approved type or shall be shown to be suitable for the particular application.

<sup>30</sup> Fuel injection is a special form of carburetion: the charging of air or gas with volatile carbon compounds. It is either an intermittent charging of air by discrete, metered quantities of fuel such as occurs on a Diesel cylinder or it is a continuous charging of air by fuel, the fuel flow being proportioned to the airflow through the engine. Examples of continuous injection are injections into the supercharger section of a reciprocating engine or into the combustion chambers of a turbine engine.

(e) Flexible hoses which might be adversely affected by exposure to high temperatures shall not be employed in locations where excessive temperatures will exist during operation or after engine shut-down.

**4b.433 Fuel lines and fittings in designated fire zones.** Fuel lines and fittings in all designated fire zones (see sec. 4b.480) shall comply with the provisions of section 4b.483.

**4b.434 Fuel valves.** In addition to the requirements of section 4b.482 for shutoff means, all fuel valves shall be provided with positive stops or suitable index provisions in the "on" and "off" positions and shall be supported so that loads resulting from their operation or from accelerated flight conditions are not transmitted to the lines attached to the valve.

**4b.435 Fuel strainer or filter.** A fuel strainer or filter shall be provided between the fuel tank outlet and the fuel metering device of the engine. The following provisions of this section shall be complied with:

(a) If an engine-driven fuel pump is provided, the strainer or filter shall be located between the tank outlet and the engine-driven pump inlet.

(b) The fuel strainer or filter shall be accessible for drainage and cleaning, and the strainer screen shall be easily removable.

(c) The strainer or filter shall be mounted in a manner not to cause its weight to be supported by the connecting lines or by the inlet or outlet connections of the strainer or filter itself.

[(d) Provision shall be made to maintain automatically the fuel flow when ice-clogging of the filter occurs, unless means are incorporated in the fuel system to prevent the accumulation of ice particles on the filter.]

(e) The fuel strainer or filter shall be of adequate capacity, commensurate with operating limitations established to insure proper service and of appropriate mesh to insure proper engine operation with the fuel contaminated to a degree, with respect to particle size and density, which can be reasonably expected to occur in service. The degree of fuel filtering shall be not less than that established for the engine in accordance with Part 13 of this subchapter.

[(Amendment 4b-12, published 27 F. R. 2986, Mar. 30, 1962, effective May 3, 1962.)]

[(4b.436 *Fuel system drains.* Drainage of the fuel system shall be accomplished by fuel strainer drains and other drains as provided in section 4b.424. The drains shall discharge clear of all portions of the airplane and shall incorporate means for positive locking of the drain in the closed position, either manually or automatically.)]

[(Amendment 4b-12, published 27 F. R. 2986, Mar. 30, 1962, effective May 3, 1962.)]

**4b.437 Fuel jettisoning system.** If the maximum takeoff weight for which the airplane is certificated exceeds 105 percent of the certificated maximum landing weight, provision shall be made for the jettisoning of fuel from the maximum takeoff to the maximum landing weight.

(a) The average rate of fuel jettisoning shall be 1 percent of the maximum takeoff weight per minute, except that the time required to jettison the fuel need not be less than 10 minutes. Compliance with these provisions shall be shown at maximum takeoff weight, with flaps and landing gear up, and in the following flight conditions:

(1) Power-off glide at a speed of  $1.4 V_{S1}$ .

(2) Climb at the one-engine-inoperative best rate-of-climb speed with the critical engine inoperative, the remaining engine(s) at maximum continuous power.

(3) Level flight at a speed of  $1.4 V_{S1}$ , if the results of tests in conditions specified in subparagraphs (1) and (2) of this paragraph indicate that this condition could be critical.

(b) During the flight tests prescribed in paragraph (a) of this section it shall be demonstrated that the fuel jettisoning system complies with the following provisions:

(1) The fuel jettisoning system and its operation shall be free of fire hazard.

(2) The fuel shall discharge clear of all portions of the airplane.

(3) Fuel or fumes shall not enter any portion of the airplane.

(4) The jettisoning operation shall not affect adversely the controllability of the airplane.

(c) The design of the jettisoning system shall be such that it would not be possible to jettison

fuel in the tanks used for takeoff and landing below the level providing 45 minutes flight at 75 percent maximum continuous power, except that it shall be permissible to jettison all fuel where an auxiliary control is provided independent of the main jettisoning control. For turbine-powered airplanes, the design of the jettisoning system shall be such that it would not be possible to jettison fuel in the tanks used for takeoff and landing below the level providing climb from sea level to 10,000 feet and thereafter providing 45 minutes cruise at a speed for maximum range.

(d) The fuel jettisoning valve shall permit the flight personnel to close the valve during any portion of the jettisoning operation. (See sec. 4b.475 for fuel jettisoning system controls.)

(e) Unless it is demonstrated that lowering of the flaps does not adversely affect fuel jettisoning, a placard shall be provided adjacent to the jettisoning control to warn flight personnel against jettisoning fuel while the flaps are lowered. A notation to this effect shall also be included in the Airplane Flight Manual. (See sec. 4b.740.)

(f) The design of the fuel jettisoning system shall be such that any reasonably probable single malfunction in the system will not result in a hazardous condition due to unsymmetrical jettisoning or inability to jettison fuel.

4b.437-1 *Test procedure for fuel jettisoning (FAA policies which apply to sec. 4b.437).*

(a) *Preliminary tests.* In the case where the maximum takeoff weight exceeds 105 percent of the maximum landing weight, provisions should be available for jettisoning fuel from the maximum takeoff weight to the maximum landing weight at the corresponding altitude range of airports for which certification is sought. If the applicant has made sufficient jettisoning tests<sup>31</sup> to prove the safety of the jettisoning system, the tests may be made with fuel only. Otherwise, preliminary tests should be made with noninflammable fluid first and the results then checked using fuel. The following procedures and methods should be observed for demon-

strating the operation of the fuel jettisoning system:

(1) *Fire hazard.*

(i) Fuel in liquid or vapor form should not impinge upon any external surface of the airplane during or after jettisoning. Colored fuel, or surfaces so treated that liquid or vaporous fuel changes the appearance of the airplane surface may be used for detection purposes. Other equivalent methods for detection may be acceptable.

(ii) Fuel in liquid or vapor form should not enter any portion of the airplane during or after jettisoning. The fuel may be detected by its scent, combustible mixture detector or by visual inspection. In supercharged aircraft the presence of liquid or vaporous fuel should be checked with the airplane unpressurized.

(iii) There should be no evidence of fuel valve leakage after it is closed.

(iv) If there is any evidence that wing flap positions, other than that used or the test may adversely affect the flow pattern, the airplane should be placarded "Fuel should not be jettisoned except when flaps are set at —°."

(v) The applicant should select for demonstration the tanks or tank combinations which are critical for demonstrating the flow rate during jettisoning.

(vi) Fuel jettisoning flow pattern should be demonstrated from all normally used tank or tank combinations on both sides of airplane whether or not both sides are symmetrical.

(vii) Fuel jettisoning rate may be demonstrated from only one side of symmetrical tank or tank combinations which are critical for flow rate.

(viii) Fuel jettisoning rate and flow pattern should be demonstrated when jettisoning from full tanks using fuel.

(2) *Control.*

(i) Changes in the airplane control qualities during the fuel jettisoning tests should be noted.

(ii) Discontinuance of fuel jettisoning should be demonstrated in flight.

(3) *Residual fuel.* The residual fuel should be measured by draining the tanks from which fuel has been jettisoned in flight, measuring the

<sup>31</sup> The basic purpose of these tests is to determine that the required amount of fuel may be safely jettisoned under reasonably anticipated operating conditions within the prescribed time limit without danger from fire, explosion, or adverse effects on the flying qualities.

total drained fuel and subtracting from the total the unusable fuel quantity for each tank to determine if there is sufficient reserve fuel after jettisoning to meet section 4b.437. This may be a ground test.

(b) *Configuration.* Fuel jettisoning tests should be conducted in the configurations that follow:

(1) *Glide.*

Weight—maximum takeoff.

C. G. position—optional.

Wing flaps—retracted or in a position desired for approval.

Landing gear—retracted or extended as desired by applicant.

Engines—poweroff, propellers windmilling.

Cowl flaps—optional.

Airspeed— $1.4 V_{s1}$ .

(2) *Climb.*

Weight—maximum takeoff.

C. G. position—optional.

Wing flaps—retracted or in a position desired for approval.

Landing gear—retracted or extended.

Operating engine(s)—maximum continuous power, cowl flaps optional.

Critical inoperative engine—throttle closed on engine most critical for fuel flow pattern, propeller feathered, cowl flaps closed.

Airspeed—one engine inoperative best rate of climb speed.

(3) *Level flight.*

Weight—maximum takeoff.

C. G. position—optional.

Wing flaps—retracted or in a position desired for approval.

Landing gear—retracted or extended.

Engines—power required for airspeed of  $1.4 V_{s1}$ .

Cowl flaps—optional.

(c) *Test procedure and required data.* When the airplane is trimmed in the configuration specified in items (b) (1) and (b) (2), the jettisoning valves should be opened and allowed to remain open until all jettisoning liquid has been disposed. If the configuration of (b) (3) of this section is critical, tests should also be conducted for this condition. This procedure

may be carried out in segments if desired. The following data should be recorded:

Time to jettison fuel.

Fuel gauge quantity at reasonable time intervals.

Pressure altitude.

Ambient air temperature.

Indicated airspeed.

Engines, r. p. m. and manifold pressure.

Carburetor air temperature.

(19 F. R. 4464, July 20, 1954, effective Sept. 1, 1954.)

## Oil System

### 4b.440 General.

(a) Each engine shall be provided with an independent oil system capable of supplying the engine with an appropriate quantity of oil at a temperature not exceeding the maximum which has been established as safe for continuous operation. (For oil system instruments see secs. 4b.604 and 4b.735.)

(b) The oil tank capacity available for the use of the engine shall not be less than the product of the endurance of the airplane under critical operating conditions times the approved maximum permissible oil consumption rate of the engine under the same conditions, plus a suitable margin to assure system circulation. In lieu of a rational analysis of airplane range for reciprocating engines, a fuel-oil ratio of 30:1 by volume shall be acceptable for airplanes not provided with a reserve or transfer system.

(c) If either an oil transfer system or a reserve oil system is provided for reciprocating engines, the total oil capacity need not exceed one gallon for each 40 gallons of fuel capacity.

(d) Oil-fuel ratios lower than those prescribed in paragraphs (b) and (c) of this section shall be acceptable if substantiated by data on the actual oil consumption of the engine.

[(Amendment 4b-12, published 27 F. R. 2986, Mar. 30, 1962, effective May 3, 1962.)]

4b.441 *Oil tank construction.* The following requirements shall apply to the construction of the oil tank:

(a) *Oil tank expansion space.*

(1) Oil tanks shall have an expansion space of not less than either 10 percent of the tank capacity or 0.5 gallon, whichever is the greater.

(2) Reserve oil tanks which have no direct connection to any engine shall have an expansion space which is not less than 2 percent of the tank capacity.

(3) It shall not be possible to fill the oil tank expansion space inadvertently when the airplane is in the normal ground attitude.

**(b) Oil tank filler connection.**

(1) Recessed oil tank filler connections which retain any appreciable quantity of oil shall incorporate a drain, and the drain shall discharge clear of all portions of the airplane.

(2) The oil tank filler cap shall provide an oil-tight seal.

(3) Oil tank filler connections shall be marked as prescribed in section 4b.738 (b).

**(c) Oil tank vent.**

(1) Oil tanks shall be vented from the top portion of the expansion space in such a manner that venting of the tank is effective under all normal flight conditions.

(2) Oil tank vents shall be arranged so that condensation of water vapor which might freeze and obstruct the line cannot accumulate at any point. (See also section 4b.483 (c).)

(d) **Oil tank outlet.** Provision shall be made either to prevent entrance into the tank itself or into the tank outlet of any foreign object which might obstruct the flow of oil through the system. The oil tank outlet shall not be enclosed by any screen or guard which would reduce the flow of oil below a safe value at any operating temperature condition.

(e) **Flexible oil tank liners.** Flexible oil tank liners shall be of an approved type or shall be shown to be suitable for the particular application.

**4b.442 Oil tank tests.**

(a) Oil tanks shall be capable of withstanding without failure all vibration, inertia, and fluid loads to which they would be subjected in operation.

(b) The provisions of section 4b.421 shall be applicable to oil tanks, except as follows:

(1) The test pressure specified in section 4b.421 (a) shall be 5 p. s. i.

(2) The test fluid specified in section 4b.421 (c) shall be oil at a temperature of 250° F.

**4b.443 Oil tank installation.** The oil tank installation shall comply with the pro-

visions of section 4b.422, except that the location of an engine oil tank in a designated fire zone shall be acceptable if the tank and its supports are of fireproof construction to the extent that damage by fire to any nonfireproof parts would not result in leakage or spillage of oil.

**4b.444 Oil lines and fittings.**

(a) **General.** The provisions of section 4b.432 shall be applicable to oil lines.

(b) **Lines and fittings in designated fire zones.** Oil lines and fittings in all designated fire zones (see sec. 4b.480) shall comply with the provisions of section 4b.483.

**(c) Engine breather lines.**

(1) Engine breather lines shall be arranged so that condensation of water vapor which might freeze and obstruct the line cannot accumulate at any point.

(2) Breathers shall discharge in a location which will not constitute a fire hazard in case foaming occurs and in a manner so that the emitted oil will not impinge upon the pilot windshield.

(3) The breather shall not discharge into the engine air induction system. (See also sec. 4b.483 (c).)

**4b.445 Oil valves.**

(a) The requirements of section 4b.482 for shutoff means shall be complied with. Closing of oil shutoff means shall not prevent feathering the propeller.

(b) All oil valves shall be provided with positive stops or suitable index provisions in the "on" and "off" positions, and they shall be supported so that loads resulting from their operation or from accelerated flight conditions are not transmitted to the lines attached to the valve.

**4b.446 Oil radiators.**

(a) Oil radiators shall be capable of withstanding without failure all vibration, inertia, and oil pressure loads to which they would be subjected in operation.

(b) Oil radiator air ducts shall be located so that, in case of fire, flames issuing from normal openings of the engine nacelle cannot impinge directly upon the radiator.

**[4b.447 Oil filters.** If the power plant installation incorporates an oil filter (strainer), the filter shall be constructed and installed so

that oil will continue to flow at the normal rate through the remainder of the system when the flow of oil through the filter element is completely blocked.]

[(Amendment 4b-12, published 27 F. R. 2986, Mar. 30, 1962, effective May 3, 1962.)]

**4b.448 Oil system drains.** Accessible drains shall be provided to permit safe drainage of the entire oil system and shall incorporate means for the positive locking of the drain in the closed position, either manually or automatically. (See also sec. 4b.483 (c).)

**4b.449 Propeller feathering system.**

(a) If the propeller feathering system is dependent upon the use of the engine oil supply, provision shall be made to trap a quantity of oil in the tank in case the supply becomes depleted due to failure of any portion of the lubricating system other than the tank itself.

(b) The quantity of trapped oil shall be sufficient to accomplish the feathering operation and shall be available only to the feathering pump.

(c) The ability of the system to accomplish feathering with the trapped supply of oil shall be demonstrated. It shall be acceptable to make this demonstration on the ground.

4b.449-1 *Procedure for demonstrating propeller feathering (FAA policies which apply to sec. 4b.449).* Tests should be conducted to demonstrate that the oil reserve for propeller feathering is adequate to accomplish the feathering procedure. This may be done on the ground by using an auxiliary source of oil for lubricating the engine during its operation.

(19 F. R. 4464, July 20, 1954, effective Sept. 1, 1954.)

### Cooling System

**[4b.450 General.** The powerplant cooling provisions shall be capable of maintaining the temperatures of powerplant components and engine fluids within the temperature limits established for such components and fluids, under all surface (ground or water) and flight operating conditions. (For cooling systems instruments see secs. 4b.604 and 4b.734.)]

[(Amendment 4b-12, published 27 F. R. 2986, Mar. 30, 1962, effective May 3, 1962.)]

**[4b.451 Cooling tests.**

**[(a) General.** Compliance with the provi-

sions of section 4b.450 shall be demonstrated by test under critical surface (ground or water) and flight operating conditions. If the tests are conducted under conditions which deviate from the maximum ambient atmospheric temperature (see paragraph (b) of this section), the recorded powerplant temperatures shall be corrected in accordance with the provisions of paragraph (c) and (d) of this section. The corrected temperatures determined in this manner shall not exceed the established limits. In the case of reciprocating engines, the fuel used during the cooling tests shall be of the minimum grade approved for the engines involved, and the mixture settings shall be those normally used in the flight stages for which the cooling tests are conducted. The test procedures shall be as outlined in sections 4b.452 and 4b.454.

**[(b) Maximum ambient atmospheric temperature.** A maximum ambient atmospheric temperature corresponding with sea level conditions shall be established by the applicant as a limitation on the operation of the airplane (see sec. 4b.718). The temperature lapse rate shall be 3.6° F. per thousand feet of altitude above sea level until a temperature of -69.7° F. is reached above which altitude the temperature shall be constant at -69.7° F.

**[(c) Correction factor.** Temperatures of all powerplant components and engine fluids, except cylinder barrels, for which temperature limits have been established, shall be corrected by adding the difference between the maximum ambient atmospheric temperature and the temperature of the ambient air at the time of the first occurrence of the maximum component or fluid temperature recorded during the cooling test, unless a more rational correction is shown to be applicable.

**[(d) Correction factor for cylinder barrel temperatures.** Cylinder barrel temperatures shall be corrected by adding 0.7 of the difference between the maximum ambient atmospheric temperature and the temperature of the ambient air at the time of the first occurrence of the maximum cylinder barrel temperature recorded during the cooling test, unless a more rational correction is shown to be applicable.]

[(Amendment 4b-12, published 27 F. R. 2986, Mar. 30, 1962, effective May 3, 1962.)]

#### 4b.452 *Cooling test procedures.*

[(a) *General.* Compliance with the provisions of section 4b.450 shall be established for the takeoff, climb, en route, and landing stages of flight which correspond with the applicable performance regulations. The cooling tests shall be conducted with the airplane in the configuration and operating under the conditions which are critical relative to cooling during each stage of flight.

[(b) *Temperature stabilization.* For all stages of flight, temperatures shall be stabilized under conditions from which entry is made into the stage of flight for which a test is conducted, except when the entry condition normally is not one during which component and engine fluid temperatures would stabilize. In such case, operation through the full entry condition shall be conducted prior to entry into the stage of flight for which the test is conducted in order to allow temperatures to attain their natural level at the time of entry. In particular, the takeoff cooling test shall be preceded by a period during which the powerplant component and engine fluid temperatures are stabilized with the engines at ground idle. A temperature shall be considered stabilized when its rate of change is less than 2 degrees F. per minute.

[(c) *Duration of test.* Cooling test for each stage of flight shall be continued until one of the following conditions is fulfilled:

[(1) Component and engine fluid temperatures stabilize;

[(2) The stage of flight is completed; or

[(3) An operating limitation is reached.

[NOTE: In the case of reciprocating engines, it may be assumed for cooling test purposes that the takeoff stage of flight is complete when the airplane has attained an altitude of 1,500 feet above the takeoff surface or a point in the takeoff where the transition from the takeoff to the en route configuration is completed and a speed is reached at which compliance with section 4b.120(c) is shown, whichever point is at a higher altitude.]

[Amendment 4b-12, published 27 F. R. 2986, Mar. 30, 1962, effective May 3, 1962.]

4b.454 *Cooling test procedure for flying boat operation.* In the case of flying boats, cooling shall be demonstrated during taxiing downwind for 10 minutes at 5 mph above the step speed.

### Induction and Exhaust Systems

#### 4b.460 *General.*

(a) The engine air induction system shall permit supplying the proper quantity of air to the engine under all conditions of operation.

(b) The induction system shall provide air for proper fuel metering and mixture distribution with the induction system valves in any position.

(c) Each reciprocating engine shall be provided with an alternate air source.

(d) Air intakes shall not open within the cowling, unless that portion of the cowling is isolated from the engine accessory section by means of a fireproof diaphragm, or unless provision is made to prevent the emergence of backfire flames.

(e) Alternate air intakes shall be so located as to preclude the entrance of rain, ice, or any other foreign matter.

(f) For turbine-engine-powered airplanes, provisions shall be made to prevent hazardous quantities of fuel leakage or overflow from drains, vents, or other components of flammable fluid systems to enter the engine intake system.

(g) For turbine engines, the air inlet ducts shall be so located or protected as to minimize the ingestion of foreign matter during takeoff, landing, or taxiing.

#### 4b.461 *Induction system deicing and anti-icing provisions.*

(a) *General.* The engine air induction system shall incorporate means for the prevention and elimination of ice accumulations.

(b) *Heat Rise.* Unless it is demonstrated that other means will accomplish the intent of paragraph (a) of this section, compliance with the following heat-rise provisions shall be demonstrated in air free of visible moisture at a temperature of 30° F.

(1) Airplanes equipped with altitude engines employing conventional venturi carburetors shall have a preheater capable of providing a heat rise of 120° F. when the engine is operating at 60 percent of its maximum continuous power.

(2) Airplanes equipped with altitude engines employing carburetors which embody features tending to reduce the possibility of ice formation shall have a preheater capable of providing a heat rise of 100° F. when the



engine is operating at 60 percent of its maximum continuous power.

(c) *Turbine powerplants.* Turbine-powered airplanes shall be capable of operation throughout the flight power range without accumulation of ice in the air induction system such as to adversely affect engine operation or cause a serious loss of power and/or thrust in the continuous maximum and intermittent maximum icing conditions as defined in section 4b.1 (b) (7) and (8). Means to indicate the functioning of the powerplant ice protection system shall be provided.

4b.461-1 *Procedure for demonstrating carburetor air heat rise (FAA policies which apply to sec. 4b.461 (b)).*

(a) *Conditions for tests.* The carburetor air temperature should be measured by a minimum of three thermocouples so arranged as to give an average air temperature. This indicator should be calibrated prior to the test. The tests should be conducted at an altitude where the free air temperature is 30° F. or at two altitudes of different temperatures, one of which is near 30° F.

(b) *Configuration.* This test should be conducted in the configuration that follows:

Weight—optional.

C. G. position—optional.

Wing flaps—optional.

Landing gear—optional.

Engines—60 percent maximum continuous power.

Cowl flaps—appropriate for flight condition.

Mixture setting—normal cruising position.

(c) *Test procedure and required data.*

(1) After all temperatures have stabilized (i. e., when the rate of temperature change is less than 2° F. per minute) and with the airplane in level flight and full cold carburetor at 60 percent maximum continuous power, the following data should be recorded:

Pressure altitude.

Ambient air temperature.

Indicated airspeed.

Carburetor air temperature.

Engines, r. p. m. and manifold pressure.

Torque pressure.

Mixture setting.

Cowl flap setting.

(2) Preheat should then be applied slowly (power may be restored to 60 percent maximum continuous at the applicant's option) and the above data recorded again after the carburetor air temperature has stabilized. The carburetor heat rise should be determined from the results of the data.

19 F. R. 4465, July 20, 1954, effective Sept. 1, 1954; amended 22 F. R. 6963, Aug. 29, 1957, effective Sept. 15, 1957.)

4b.462 *Carburetor air preheater design.* Carburetor air preheaters shall incorporate the following provisions:

(a) Means shall be provided to assure ventilation of the preheater when the engine is being operated with cold air.

(b) The preheater shall be constructed to permit inspection of exhaust manifold parts which it surrounds and also to permit inspection of critical portions of the preheater itself.

4b.463 *Induction system ducts.* Induction system ducts shall incorporate the following provisions:

(a) Induction system ducts ahead of the first stage of the supercharger shall be provided with drains to prevent hazardous accumulations of fuel and moisture in the ground attitude. The drains shall not discharge in locations which might cause a fire hazard.

(b) Sufficient strength shall be incorporated in the ducts to prevent induction system failures resulting from normal backfire conditions.

(c) Ducts which are connected to components of the airplane between which relative motion could exist shall incorporate provisions for flexibility.

(d) Induction system ducts within any fire zone for which a fire-extinguishing system is required shall be of fire-resistant construction.

4b.464 *Induction system screens.* If induction system screens are employed, they shall comply with the following provisions:

(a) Screens shall be located upstream from the carburetor.

(b) Screens shall not be located in portions of the induction system which constitute the only passage through which air can reach the engine, unless the screen is so located that it can be deiced by heated air.

(c) Deicing of induction system screens by means of alcohol alone shall not be acceptable.

(d) It shall not be possible for fuel to impinge upon the screens.

**4b.466 *Inter-coolers and after-coolers.***  
Inter-coolers and after-coolers shall be capable of withstanding without failure all vibration, inertia, and air pressure loads to which they would be subjected in operation.

**4b.467 *Exhaust system and installation components.***

(a) *General.*

(1) The exhaust system shall be constructed and arranged to assure the safe disposal of exhaust gases without the existence of a fire hazard or carbon monoxide contamination of air in personnel compartments.

(2) Unless appropriate precautions are taken, exhaust system parts shall not be located in hazardous proximity to portions of any system carrying flammable fluids or vapors nor shall they be located under portions of such systems where the latter could be subject to leakage.

(3) All airplane components upon which hot exhaust gases might impinge, or which could be subjected to high temperatures due to proximity to exhaust system parts, shall be constructed of fireproof material. All exhaust system components shall be separated by means of fireproof shields from adjacent portions of the airplane which are outside the engine compartment.

(4) Exhaust gases shall not discharge in a manner to cause a fire hazard with respect to any flammable fluid vent or drain.

(5) Exhaust gases shall not discharge at a location which will cause a glare seriously affecting pilot visibility at night.

(6) All exhaust system components shall be ventilated to prevent the existence of points of excessively high temperature.

(7) Exhaust shrouds shall be ventilated or insulated to avoid during normal operation a temperature sufficiently high to ignite any flammable fluids or vapors external to the shrouds.

(b) *Exhaust piping.*

(1) Exhaust piping shall be constructed of material resistant to heat and corrosion, and shall incorporate provisions to prevent failure due to expansion when heated to operating temperatures.

(2) Exhaust pipe shall be supported to withstand all vibration and inertia loads to which they would be subjected in operation.

(3) Portions of the exhaust piping which are connected to components between which relative motion could exist shall incorporate provisions for flexibility.

(c) *Exhaust heat exchangers.*

(1) Exhaust heat exchangers shall be constructed and installed to assure their ability to withstand without failure all vibration, inertia, and other loads to which they would be subjected in operation.

(2) Heat exchangers shall be constructed of materials which are suitable for continued operation at high temperatures and which are resistant to corrosion due to elements contained in exhaust gases.

(3) Provision shall be made for the inspection of all critical portions of exhaust heat exchangers.

(4) Heat exchangers shall incorporate cooling provisions wherever they are subject to contact with exhaust gases.

(5) Heat exchangers or mufflers shall incorporate no stagnant areas or liquid traps which would increase the possibility of ignition of flammable fluids or vapors which might be present in case of failure or malfunctioning of components carrying flammable fluids.

(d) *Exhaust heating of ventilating air.*  
If an exhaust heat exchanger is used for heating ventilating air, a secondary heat exchanger shall be provided between the primary exhaust gas heat exchanger and the ventilating air system, unless it is demonstrated that other means used preclude harmful contamination of the ventilating air.

(e) *Exhaust driven turbo-superchargers.*

(1) Exhaust driven turbines shall be of an approved type or shall be shown to be suitable for the particular application. They shall be installed and supported to assure their safe operation between normal inspection and overhaul periods.

(2) Provision for expansion and flexibility shall be made between exhaust conduits and the turbine.

(3) Provision shall be made for lubrication of the turbine and for cooling of those turbine parts where the temperatures are critical.

(4) Means shall be provided so that, in the event of malfunctioning of the normal turbo-supercharger control system, the turbine speed will not be greater than its maximum allowable value. The components provided for this purpose shall be independent of the normal turbo-supercharger controls with the exception of the waste gate operating components themselves.

4b.467-1 *Carbon monoxide detection (FAA policies which apply to sec. 4b.467 (a) (1) and (d)).*

(a) *Conditions for tests.* Any acceptable carbon monoxide detection method may be used in demonstrating compliance with section 4b.467 (a) (1) and (d), and with the ventilating requirements of section 4b.371. The tests should be conducted with the airplane's heater system in operation if there is any possibility of a system containing carbon monoxide. In aircraft employing thermal deicing, tests should be conducted with the system operating at full capacity.

(b) *Configuration.* Carbon monoxide tests should be conducted in the configurations that follow:

- (1) *Power-on level flight.*  
Weight—optional.  
C. G. position—optional.  
Wing flaps—retracted.  
Landing gear—retracted.  
Engines—maximum continuous power.  
Cowl flaps—appropriate for flight condition.
- (2) *Power-off glide.*  
Wing flaps—retracted.  
Landing gear—retracted.  
Engines—idling.  
Cowl flaps—appropriate for flight condition.
- (3) *Power approach.*  
Wing flaps—approach position.  
Landing gear—extended.  
Engines—power for level flight.  
Cowl flaps—appropriate for flight condition.  
Airspeed—any speed from 1.4  $V_{S1}$  to 1.6  $V_{S1}$ .

(c) *Test procedure and required data.* The air should be sampled with a carbon monoxide indicator in front of cabin heater opening(s)

with heat on and at representative passenger and crew locations. If the airplane does not have pressurization equipment installed, the air should be sampled at the above locations with the windows closed and also partially opened. If the airplane is equipped for pressurization, carbon monoxide indications should be taken when the cabin is pressurized and also unpressurized.

(19 F. R. 4465, July 20, 1954, effective Sept. 1, 1954.)

4b.467-2 *Determination of exhaust gas interference with visibility (FAA policies which apply to sec. 4b.467 (a) (5)).* The effects of exhaust gas interference with visibility should be observed during tests to demonstrate other night flying requirements.

(19 F. R. 4466, July 20, 1954, effective Sept. 1, 1954.)

## Powerplant Controls and Accessories

### 4b.470 *Powerplant controls; general.*

The provisions of section 4b.353 shall be applicable to all powerplant controls with respect to location, grouping, and direction of motion, and the provisions of section 4b.737 shall be applicable to all powerplant controls with respect to marking. In addition all powerplant controls shall comply with the following:

(a) Controls shall be so located that they cannot be inadvertently operated by personnel entering, leaving, or making normal movements in the cockpit.

(b) Controls shall maintain any set position without constant attention by flight personnel. They shall not tend to creep due to control loads or vibration.

(c) Flexible controls shall be of an approved type or shall be shown to be suitable for the particular application.

(d) Controls shall have strength and rigidity to withstand operating loads without failure and without excessive deflection.

### 4b.471 *Throttle and A. D. I. system controls.*

(a) A separate throttle control shall be provided for each engine. Throttle controls shall be grouped and arranged to permit separate control of each engine and also simultaneous control of all engines.

(b) Throttle controls shall afford a positive and immediately responsive means of controlling the engines.

(c) If an antidetonant injection system is provided, the flow of ADI fluid shall be automatically controlled in relation to the amount of power produced by the engine. In addition to the automatic control, a separate control shall be provided for the ADI pumps.

#### 4b.472 Ignition switches.

(a) Ignition switches shall provide control for each ignition circuit on each engine.

(b) Means shall be provided for quickly shutting off all ignition by the grouping of switches or by providing a master ignition control.

(c) If a master ignition control is provided, a guard shall be incorporated to prevent inadvertent operation of the control.

#### 4b.473 Mixture controls.

(a) If mixture controls are provided, a separate control shall be provided for each engine. The mixture controls shall be grouped and arranged to permit separate control of each engine and also simultaneous control of all engines.

(b) Any intermediate position of the mixture control which corresponds with a normal operating setting shall be provided with a sensory and a visual identification.

(c) The mixture controls shall be placed in a location accessible to both pilots, except where a separate flight engineer station with a control panel is provided, in which case the mixture controls shall be accessible to the flight engineer.

#### 4b.474 Propeller controls.

##### (a) Propeller speed and pitch controls.

(1) A separate propeller speed and pitch control shall be provided for each propeller. The propeller speed and pitch controls shall be grouped and arranged to permit separate control of each propeller and also simultaneous control of all propellers.

(2) The propeller speed and pitch controls shall provide for synchronization of all propellers. (See also sec. 4b.404.)

(3) Propeller speed and pitch control(s) shall be placed to the right of the pilot's throttle and shall be at least 1 inch lower than the throttle controls.

##### (b) Propeller feathering controls.

(1) A separate propeller feathering control shall be provided for each propeller.

(2) Propeller feathering controls shall be provided with means to prevent inadvertent operation.

(3) If feathering is accomplished by movement of the propeller pitch or speed control lever, provision shall be made to prevent the movement of this control to the feathering position during normal operation.

4b.474-1 Propeller feathering pump motors, intermittent duty type (FAA policies which apply to sec. 4b.474 (b)).

(a) An intermittent duty type motor<sup>32</sup> in the propeller feathering control system should automatically stop or be made to stop upon the completion of the feathering operation by any of the following means:

(1) Installation of a pressure cutout switch in the feathering button holding coil circuit.

(2) Installation of a timer switch in the feathering button holding coil circuit.

(3) Manually interrupting the feathering pump circuit by pulling out the feathering button. In this arrangement, a warning light should be installed in the pump circuit to illuminate while the pump motor is operating. The light may be either in the feathering button or adjacent to it.

(b) Timer switches of either the mechanical or the thermal types are acceptable.

(22 F. R. 6885, Aug. 27, 1957, effective Sept. 15, 1957.)

#### 4b.474a Reverse thrust controls.

(a) Propeller reverse thrust controls shall incorporate a means to prevent their inadvertent movement to a reverse thrust position. The means provided shall incorporate a positive lock or stop at the flight idle position and shall require a separate and distinct operation by the crew in order to displace the control from the flight regime.

(b) Turbojet reverse thrust controls shall incorporate a means to prevent their inadvertent movement to a reverse thrust position. The means provided shall incorporate a positive lock or stop at the flight idle position and shall require a separate and distinct operation by the

<sup>32</sup> Intermittent duty type motors may fail if operated continuously for more than two minutes.

crew in order to displace the control from the forward thrust regime.

**4b.475 Fuel system controls.** (See also sec. 4b.434.)

(a) Fuel jettisoning system controls shall be provided with guards to prevent their inadvertent operation.

(b) Fuel jettisoning system controls shall not be located in close proximity to fire extinguisher controls nor to any other controls intended to combat fire.

**4b.476 Carburetor air preheat controls.**

Separate carburetor air preheat controls shall be provided to regulate the temperature of the carburetor air for each engine.

**4b.476a Supercharger controls.** Supercharger controls shall be accessible to the pilots, except where a separate flight engineer station with a control panel is provided, in which case they shall be accessible to the flight engineer.

**4b.477 Powerplant accessories.**

(a) Engine mounted accessories shall be of a type approved for installation on the engine involved, and shall utilize the provisions made on the engine for mounting.

(b) Items of electrical equipment subject to arcing or sparking shall be installed to minimize the possibility of their contact with any flammable fluids or vapors which might be present in a free state.

(c) If continued rotation of an engine-driven cabin supercharger or any remote accessory driven by the engine will constitute a hazard in case malfunctioning occurs, means shall be provided to prevent hazardous rotation of such accessory without interfering with the continued operation of the engine. (See also sec. 4b.371 (c).)

NOTE: Hazardous rotation may involve consideration of mechanical damage or sustained air flows which may be dangerous under certain conditions.

**4b.478 Engine ignition systems.**

(a) Battery ignition systems shall be supplemented with a generator which is automatically made available as an alternate source of electrical energy to permit continued engine operation in the event of the depletion of any battery.

(b) The capacity of batteries and generators shall be sufficient to meet the simultaneous

demands of the engine ignition system and the greatest demands of any airplane electrical system components which would draw electrical energy from the same source.

(1) The design of the engine ignition system shall take into consideration the condition of an inoperative generator and the condition of a completely depleted battery when the generator is running at its normal operating speed.

(2) If only one battery is provided the design of the engine ignition system shall take into consideration the condition in which the battery is completely depleted and the generator is operating at idling speed.

(3) Portions of magneto ground wires for separate ignition circuits which lie on the engine side of the fire wall shall be installed, located, or protected so as to minimize the possibility of simultaneous failure of two or more wires as a result of mechanical damage, electrical faults, etc.

(4) Ground wires for any engine shall not be routed through fire zones, except those associated with the engine which the wires serve, unless those portions of the wires which are located in such fire zones are fireproof or are protected against the possibility of damage by fire in a manner to render them fireproof. (See sec. 4b.472 for ignition switches.)

(5) Ignition circuits shall be electrically independent of all other electrical circuits except circuits used for analyzing the operation of the ignition system.

(c) Means shall be provided to warn flight personnel if malfunctioning of any part of the electrical system is causing the continuous discharging of a battery which is necessary for engine ignition. (See sec. 4b.472 for ignition switches.)

## Powerplant Fire Protection

**4b.480 Designated fire zones.**

(a) Designated fire zones shall comprise the following regions:

- (1) Engine power section,
- (2) Engine accessory section,
- (3) Complete powerplant compartments in which no isolation is provided between the engine power section and the engine accessory section,
- (4) Auxiliary power unit compartments,

(5) Fuel-burning heaters and other combustion equipment installations as defined by section 4b.386.

(6) Compressor and accessory sections of turbine engines.

(7) Combustor, turbine, and tailpipe sections of turbine engine installations which contain lines or components carrying flammable fluids or gases, except that the fire extinguisher system specified in section 4b.484 need not be provided for such sections if it is demonstrated that any fire occurring therein can be otherwise controlled.

NOTE: See also section 4b.385.

(b) Designated fire zones shall be protected from fire by compliance with sections 4b.481 through 4b.490.

(c) The nacelle area immediately behind the fire wall shall comply with the provisions of sections 4b.385, 4b.463 (d), 4b.478 (b)(4), 4b.481 (c), 4b.482 through 4b.485, and 4b.489. If a retractable landing gear is located in this area, compliance with this paragraph is required only with the landing gear retracted.

#### 4b.481 *Flammable fluids.*

(a) No tanks or reservoirs which are a part of a system containing flammable fluids or gases shall be located in designated fire zones, except where the fluid contained, the design of the system, the materials used in the tank, the shutoff means, all connections, lines, and controls are such as to provide an equally high degree of safety.

(b) Not less than one-half inch of clear air space shall be provided between any tank or reservoir and a firewall or shroud isolating a designated fire zone.

(c) If absorbent materials are located in proximity to flammable fluid system components which might be subject to leakage, such materials shall be covered or treated to prevent the absorption of hazardous quantities of fluids.

#### 4b.482 *Shutoff means.*

(a) Means for each individual engine and for each individual fire zone specified in section 4b.480 (a) (4) and (5) shall be provided for shutting off or otherwise preventing hazardous quantities of fuel, oil, deicer, and other flammable fluids from flowing into, within, or through any designated fire zone, except that

means need not be provided to shut off flow in lines forming an integral part of an engine. Closing the fuel shutoff valve for any engine shall not make any of the fuel supply unavailable to the remaining engines.

(b) Operation of the shutoff means shall not interfere with the subsequent emergency operation of other equipment, such as feathering the propeller.

(c) The shutoff means shall be located outside of designated fire zones, unless an equally high degree of safety is otherwise provided (see sec. 4b.481). It shall be shown that no hazardous quantity of flammable fluid could drain into any designated fire zone after shutting off has been accomplished.

(d) Provisions shall be made to guard against inadvertent operation of the shutoff means and to make it possible for the crew to reopen the shutoff means in flight after it has once been closed.

#### 4b.483 *Lines and fittings.*

(a) All lines and fittings carrying flammable fluids in designated fire zones shall be fire-resistant, except as otherwise provided in this section. If flexible hose is used, the assembly of hose and end fittings shall be of an approved type. The provisions of this paragraph need not apply to those lines and fittings which form an integral part of the engine.

(b) Vent and drain lines and their fittings shall be subject to the provisions of paragraph (a) of this section unless a failure of such line or fitting will not result in, or add to, a fire hazard.

#### 4b.484 *Fire extinguisher systems.*

##### (a) *General.*

(1) Fire extinguisher systems shall be provided to serve all designated fire zones. This requirement shall be effective with respect to applications for type certificates in accordance with the provisions of section 4b.11(a). In addition, all other airplanes manufactured after June 30, 1954, shall comply with this requirement, unless the engine power section is completely isolated from the engine accessory section by a fireproof diaphragm and unless the cowling and nacelle skin comply with the provisions of section 4b.487, in which case fire

extinguisher systems need not be provided in the engine power section.

NOTE: Induction systems for reciprocating engines are considered to be located in a designated fire zone, and therefore subject to the fire extinguisher protection provisions unless tests or experience with the particular type of induction and carburetion systems shows that fuel burning in the induction system passages is not likely to occur.

(2) The fire extinguishing system, the quantity of extinguishing agent, and the rate of discharge shall be such as to provide two adequate discharges. It shall be possible to direct both discharges to any main engine installation. Individual "one-shot" systems shall be acceptable in the case of auxiliary power units, fuel-burning heaters, and other combustion equipment.

(3) The fire-extinguishing system for a nacelle shall be capable of protecting simultaneously all zones of the nacelle for which protection is provided.

(b) *Fire extinguishing agents.*

(1) Extinguishing agents employed shall be methyl bromide, carbon dioxide, or any other agent which has been shown to provide equivalent extinguishing action.

(2) If methyl bromide, carbon dioxide, or any other toxic extinguishing agent is employed, provision shall be made to prevent the entrance of harmful concentration of fluid or fluid vapors into any personnel compartments either due to leakage during normal operation of the airplane or as a result of discharging the fire extinguisher on the ground or in flight even though a defect may exist in the extinguishing system. Compliance with this requirement shall be demonstrated by appropriate tests.

(3) If a methyl bromide system is provided, the containers shall be charged with a dry agent and shall be sealed by the fire extinguisher manufacturer or by any other party employing appropriate recharging equipment.

(c) *Extinguishing agent container pressure relief.* Extinguisher agent containers shall be provided with a pressure relief to prevent bursting of the container due to excessive internal pressures. The following provisions shall apply:

(1) The discharge line from the relief connection shall terminate outside the airplane in a

location convenient for inspection on the ground.

(2) An indicator shall be provided at the discharge end of the line to provide a visual indication when the container has discharged.

(d) *Extinguishing agent container compartment temperature.* Under all conditions in which the airplane is intended for operation, the temperature range of the extinguishing agent containers shall be maintained to assure that the pressure in the containers can neither fall below the minimum necessary to provide an adequate rate of extinguisher agent discharge nor rise above a safe limit so that the system will not be prematurely discharged.

(e) *Fire-extinguishing system materials.* Materials in the fire extinguishing system shall not react chemically with the extinguishing agent so as to constitute a hazard. All components of the fire extinguishing systems located in designated fire zones shall be constructed of fireproof materials.

[(Amendment 4b-12, published 27 F. R. 2986, Mar. 30, 1962, effective May 3, 1962.)]

4b.484-1 *Determination of carbon dioxide concentration in flight crew compartments. (FAA policies which apply to sec. 4b.484(b)).*

(a) Carbon dioxide has been found to adversely affect flight crew personnel in the performance of their duties. Therefore, in aircraft equipped with built-in carbon dioxide fuselage compartment fire extinguishing systems, the carbon dioxide concentration occurring at the flight crew stations as a result of discharging the fire extinguishers should be determined in accordance with paragraphs (b) and (c) of this section, except that such determination is not considered necessary if:

(1) Five pounds or less of carbon dioxide will be discharged into any one such fuselage compartment in accordance with established fire control procedures, or

(2) Protective breathing equipment is provided for each flight crew member on flight deck duty.

(b) The carbon dioxide concentrations at breathing level at the flight crew stations should be determined in flight tests during which fuselage compartment fire extinguishers are discharged in accordance with established fire

control procedures. Since carbon dioxide is heavier than air, a nose down attitude is likely to produce the critical concentrations in the crew compartment. The following conditions should therefore be investigated:

(1) A rapid descent at the "[maximum operating limit]" speed of the airplane with flaps and landing gear up,

(2) A rapid descent with flaps and landing gear down, at the maximum permissible speed for this configuration. If it appears that any other condition is likely to be critical on a particular airplane, it should also be investigated.

(c) In the flight tests specified in paragraph (b) of this section, it will be permissible to institute emergency ventilating procedures immediately prior to or following the discharge of carbon dioxide, provided such procedures can be accomplished easily and quickly by the flight crew and do not appreciably reduce the effectiveness of the fire protection system.

(d) If the carbon dioxide concentrations determined in accordance with paragraphs (b) and (c) of this section, exceed 3 percent by volume (corrected to standard sea-level conditions), protective breathing equipment should be provided for each flight crewmember on flight deck duty.

(e) Appropriate emergency operating procedures should be entered in the Airplane Flight Manual.

(15 F. R. 8904, Dec. 15, 1950, effective Dec. 15, 1950; [amended 27 F. R. 2986, Mar. 30, 1962, effective May 3, 1962.]

**4b.485 Fire-detector systems.** Quick-acting fire or overheat detectors of an approved type shall be provided in all designated fire zones and in the combustion, turbine, and tailpipe sections of turbine-engine installations, and they shall be sufficient in number and location to assure prompt detection of fire in such zones and sections. Fire detectors shall comply with the following provisions:

(a) Fire detectors shall be constructed and installed to assure their ability to resist without failure all vibration, inertia, and other loads to which they would be subjected in operation.

(b) Fire detectors shall be unaffected by the exposure to oil, water, or other fluids or fumes which might be present.

(c) Means shall be provided to permit the crew to check in flight the functioning of the electric circuit associated with the fire-detection system.

(d) Wiring and other components of detector systems which are located in fire zones shall be of fire-resistant construction.

(e) Detector system components for any fire zone shall not pass through other fire zones, unless they are protected against the possibility of false warnings resulting from fires in zones through which they pass. This requirement shall not be applicable with respect to zones which are simultaneously protected by the same detector and extinguisher systems.

4b.485-1 *Fire detector test circuit (FAA policies which apply to sec. 4b.485 (c)).*

(a) The checking means should serve to assure the crew that a fire within the zone of coverage will produce a fire warning if all fire-responsive (detector) elements are operative. The means need not be designed to disclose whether fire detector sensor elements themselves would respond properly to a fire.<sup>33</sup>

(b) The check should reveal any probable malfunction or failure in the fire-detection system, external to the detector elements, which could interfere with, or prevent, fire warning. Open and short circuits in wiring, and inoperative lights, bells, switches, or relays are examples of malfunctions which should be revealed by such a check.

(22 F. R. 6885, Aug. 27, 1957, effective Sept. 15, 1957.)

**4b.486 Firewalls.** All engines, auxiliary power units, fuel-burning heaters, and other combustion equipment which are intended for operation in flight as well as the combustion, turbine, and tailpipe sections of turbine engines shall be isolated from the remainder of the airplane by means of firewalls, shrouds, or other equivalent means. The following shall apply:

(a) Firewalls and shrouds shall be constructed in such a manner that no hazardous quantity of air, fluids, or flame can pass from the compartment to other portions of the airplane.

<sup>33</sup> This is normally a separate ground maintenance operation.



(b) All openings in the firewall or shroud shall be sealed with close-fitting fireproof grommets, bushings, or firewall fittings.

(c) Firewalls and shrouds shall be constructed of fireproof material and shall be protected against corrosion.

#### 4b.487 *Cowling and nacelle skin.*

(a) Cowling shall be constructed and supported so as to make it capable of resisting all vibration, inertia, and air loads to which it would be subjected in operation.

(b) Cowling shall have drainage and ventilation provisions as prescribed in section 4b.489.

(c) On airplanes equipped with a diaphragm [to isolate the engine power section from the engine accessory section,] the parts of the accessory section cowling which might be subjected to flame in the event of a fire in the engine power section of the nacelle shall be constructed of fireproof material and shall comply with the provisions of section 4b.486.

(d) Those portions of the cowling which would be subjected to high temperatures due to their proximity to exhaust system parts or exhaust gas impingement shall be constructed of fireproof material.

(e) The airplane shall be so designed and constructed that, in the event of fire originating in the engine power or accessory sections, the probability is extremely remote for fire to enter either through openings or by burning through external skin into any other zone of the nacelle where such fire could create additional hazards. If the airplane is provided with a retractable landing gear, this provision shall apply with the landing gear retracted. Fireproof materials shall be used for all nacelle skin areas which might be subjected to flame in the event of a fire originating in the engine power or accessory sections.

[Amendment 4b-12, published 27 F. R. 2986, Mar. 30, 1962, effective May. 3, 1962.]

#### 4b.489 *Drainage and ventilation of fire zones.*

(a) Complete drainage of all portions of designated fire zones shall be provided to minimize the hazards resulting from failure or malfunctioning of components containing flammable fluids. The drainage provisions shall be effective under conditions expected to prevail when drainage is needed and shall be so arranged that the discharged fluid will not cause an additional fire hazard.

(b) All designated fire zones shall be ventilated to prevent the accumulation of flammable vapors. Ventilation openings shall not be placed in locations which would permit the entrance of flammable fluids, vapors, or flame from other zones. The ventilation provisions shall be so arranged that the discharged vapors will not cause an additional fire hazard.

(c) Except with respect to the engine power section of the nacelle and the combustion heater ventilating air ducts, provision shall be made to permit the crew to shut off sources of forced ventilation in any fire zone, unless the extinguishing agent capacity and rate of discharge are based on maximum air flow through the zone.

#### 4b.490 *Protection of other airplane components against fire.*

(a) All airplane surfaces aft of the nacelles, in the region of one nacelle diameter on both sides of the nacelle centerline, shall be constructed of fire-resistant material. This provision need not be applied to tail surfaces lying behind nacelles, unless the dimensional configuration of the aircraft is such that the tail surfaces could be affected readily by heat, flames, or sparks emanating from a designated fire zone or engine compartment of any nacelle.

(b) Consideration shall be given to the effect on adjacent parts of the airplane of heat within designated fire zones and within the combustion, turbine, and tailpipe sections of turbine engines.

## Subpart F—Equipment

### General

4b.600 *Scope.* The required basic equipment as prescribed in this subpart is the minimum which shall be installed in the airplane

for certification. Such additional equipment as is necessary for a specific type of operation is prescribed in the operating rules of this subchapter.

**4b.601 Functional and installational requirements.** Each item of equipment shall be:

(a) Of a type and design appropriate to perform its intended function,

(b) Labeled as to its identification, function, or operational limitations, or any combination of these, whichever is applicable,

(c) Installed in accordance with specified limitations of the equipment,

(d) Demonstrated to function properly in the airplane.

**4b.602 Required basic equipment.** The equipment listed in sections 4b.603 through 4b.605 shall be the required basic equipment. (See sec. 4b.600.)

**4b.603 Flight and navigational instruments.** (See sec. 4b.612 for installation requirements.)

(a) Airspeed indicating system. If the airspeed limitations vary with altitude, the airspeed indicator shall incorporate a maximum allowable airspeed indication showing the variation of  $[V_{MO}/M_{MO}]$  with altitude including compressibility limitations. (See sec. 4b.732.)

(b) Altimeter (sensitive or precision type),

(c) Rate-of-climb indicator (vertical speed),

(d) Free air temperature indicator,

(e) Clock (sweep-second pointer type),

(f) Rate-of-turn indicator (gyroscopic type with integral bank or slip indicator),

(g) Bank and pitch indicator (gyroscopically stabilized),

(h) Direction indicator (gyroscopically stabilized magnetic and/or nonmagnetic type),

(i) Direction indicator (nonstabilized type magnetic compass),

(j) Machmeter for airplanes having compressibility limitations not otherwise indicated to the pilot in accordance with section 4b.732.

[(k) Speed warning device for all turbine-powered airplanes and for all other airplanes for which  $V_{MO}/M_{MO}$  is greater than  $0.8 V_{DF}/M_{DF}$  or  $0.8 V_D/M_D$ . The device shall provide effective aural warning to the pilots which is distinctively different from aural warnings used for other purposes, whenever the speed exceeds  $V_{MO}$  plus 6 knots or  $M_{MO} + 0.01$ . The upper limit of the production tolerance permitted for the

warning device shall be at a speed not greater than the prescribed warning speed.]

[(Amendment 4b-12, published 27 F. R. 2986, Mar. 30, 1962, effective May 3, 1962.)]

**4b.604 Powerplant instruments.** (See sec. 4b.613 for installation requirements.)

(a) Carburetor air temperature indicator for each reciprocating engine.

(b) Cylinder head temperature indicator for each air-cooled reciprocating engine.

(c) Gas temperature indicator for each turbine engine.

(d) Manifold pressure indicator for each reciprocating engine.

(e) Fuel pressure indicator for each reciprocating engine to indicate the pressure under which the fuel is being supplied.

(f) Fuel pressure warning means for each engine or a master warning means for all engines with provision for isolating the individual warning means from the master warning means.

(g) Fuel flowmeter indicator for each turbine engine. For reciprocating engines, a fuel flowmeter or fuel mixture indicator for each engine not equipped with an automatic altitude mixture control.

(h) Fuel quantity indicator for each fuel tank.

(i) Augmentation liquid quantity indicator for each tank, which is appropriate to the manner in which the liquid is to be used in operations.

(j) Oil quantity indicator for each oil tank. (See sec. 4b.613 (d).)

(k) Oil pressure indicator for each independent pressure oil system of each engine.

(l) Oil pressure warning means for each engine or a master warning means for all engines with provision for isolating the individual warning means from the master warning means.

(m) Oil temperature indication for each engine.

(n) Tachometer for each reciprocating engine.

(o) Tachometer for each turbine engine to indicate the speed of the rotors for which limiting speeds have been established.

(p) Fire-warning indicators. (See sec. 4b.485.)

[(q) An indicator for each turbojet engine to indicate a change in thrust, resulting from any deficiency in the engine or an indicator to indicate a gas stream pressure which can be related to thrust.]

(r) A torque indicator for each turbinepropeller engine. A device for each reciprocating engine capable of indicating to the flight crew during flight any change in the power output if the engine is equipped with an automatic propeller feathering system, the operation of which is initiated by a power output measuring system, or if the total engine cylinder displacement is 2,000 cubic inches or more.

(s) Position indicating means for each propeller on a turbine engine to indicate to the flight crew when the propeller blade angle is below the flight low pitch position (see sec. 4b.613). For reciprocating engines, a means for each reversing propeller to indicate to the pilot when the propeller is in reverse pitch.

(t) Position indicating means for each turbine engine utilizing a thrust reversing device to indicate to the flight crew when the device is in the reverse thrust position.

[(Amendment 4b-12, published 27 F. R. 2986, Mar. 30, 1962, effective May. 3, 1962.)]

#### 4b.605 *Miscellaneous equipment.*

(a) Approved seats for all occupants (see sec. 4b.358),

(b) Approved safety belts for all occupants (see sec. 4b.643),

(c) Deleted.

(d) Source(s) of electrical energy (see sec. 4b.620),

(e) Electrical protective devices (see sec. 4b.624),

(f) Radio communication system (two-way),

(g) Radio navigation system,

(h) Windshield wiper or equivalent for each pilot,

(i) Ignition switch for each and all engines (see sec. 4b.472),

(j) Approved portable fire extinguisher (see sec. 4b.641).

#### 4b.606 *Equipment, systems, and installations.*

(a) *Functioning and reliability.* All equipment, systems, and installations the functioning of which is necessary in showing compliance with the regulations in this subchapter

shall be designed and installed to insure that they will perform their intended functions reliably under all reasonably foreseeable operating conditions.

(b) *Hazards.* All equipment, systems, and installations shall be designed to safeguard against hazards to the airplane in the event of their malfunctioning or failure.

(c) *Power supply.* Where an installation the functioning of which is necessary in showing compliance with the regulations of this subchapter requires a power supply, such installation shall be considered an essential load on the power supply, and the power sources and the system shall be capable of supplying the following power loads in probable operating combinations and for probable durations:

(1) All loads connected to the system with the system functioning normally;

(2) All essential loads after failure of any one prime mover, power converter, or energy storage device;

(3) All essential loads after failure of any one engine on two- or three-engine airplanes, or after failure of any two engines on four-or-more-engine airplanes.

(4) In determining the probable operating combinations and durations of essential loads for the partial power failure conditions prescribed in subparagraphs (2) and (3) of this paragraph, it shall be permissible to assume that the power loads are reduced in accordance with a monitoring procedure which is consistent with safety in the types of operations authorized. If a particular load is not required to maintain controlled flight it need not be considered for the two-engine-inoperative condition on airplanes with four or more engines as prescribed in subparagraph (3) of this paragraph.

4.606-1 *Safety criteria<sup>24</sup> for electric utilization systems (FAA policies which apply to sec. 4b.606 (a) and (b)).* Electric utilization sys-

<sup>24</sup> When applying these criteria to particular systems, it should be clear that the degree of hazard resulting from a type of malfunction may vary considerably with the type of aircraft in which the system is installed, or with the nature of the operation in which the aircraft is utilized. Examples of systems which should be considered under certain of the above criteria are as follows: (a) Basic flight instruments, minimum navigation equipment; (b) propeller reversing system, trim-tab system, dive brake system, landing gear actuation systems; (c) fuel control valve system, propeller control system; (d) landing gear indicating system, radio navigation system, instrument landing system, gyroscopic instrument systems. Additional safety criteria are contained in sections of this part applicable to particular systems and components of the airplane.

tems<sup>35</sup> should be analyzed, inspected or tested to assure conformance to the following safety criteria.

(a) *Loss of system function.* The system should not be rendered inoperative by any probable malfunction,<sup>36</sup> if operation of this system is necessary to maintain controlled flight or effect a safe landing for any authorized flight operation.

(b) *Inadvertent operation of system.* The system should not be inadvertently set into operation by any probable malfunction, if such inadvertent operation can result in the inability to maintain controlled flight or effect a safe landing for any authorized flight operation.

(c) *Systems serving two or more engines.* No probable malfunction in the system should adversely affect the performance of more than one propulsion engine, consistent with the provisions of section 4b.401 (b).

(d) *System independence.* No probable malfunction in one system should render another system inoperative, if both systems are necessary in showing compliance with this part.

(e) *Misleading system indicators.* No probable malfunction in the system should result in a safe indication of an unsafe condition of flight, if such misleading information can result in the inability to maintain controlled flight or effect a safe landing for any authorized flight operation.

(f) *System overheat.* No probable malfunction in the system should result in overheat of electric equipment, such that hazardous quantities of smoke are generated within the cabin, or such that a fire hazard is created, unless adequate means are provided to detect and correct the overheat condition during flight.

(g) *Electric shock exposure.* No probable malfunction in the system should expose crew

or passengers to harmful electric shock, during any normal activity on the aircraft.

(21 F. R. 2747, Apr. 28, 1956, effective May 25, 1956.)

4b.606-2 *Installation of flight recorders (FAA policies which apply to sec. 4b.606).* Flight recorders required under Parts 40, 41, and 42 of this subchapter as amended should be installed in the airplane in conformance with the following:

(a) *Location of flight recorder.* The recorder should be located in accordance with the applicable type in the following:

Type I—Unrestricted location,

Type II—Restricted to any location more than  $\frac{1}{2}$  of the wing root chord from the main wing structure through the fuselage and from any fuel tanks,

Type III—Unrestricted location.

(b) *Vertical acceleration sensing.*

(1) The vertical acceleration forces should be sensed at a location within or adjacent to the fuselage, and within or as close to the center of gravity range of the airplane as practicable.

(2) The vertical acceleration sensor, or the unit in which it is contained, should be attached to a rigid structural member of the airplane so that vertical acceleration forces present in that area can be sensed with a minimum of error.

(3) Sensing of only the in-flight vertical acceleration forces is necessary; impact forces need not be sensed.

(c) *Connection to sources of data.* The airspeed, altitude, and heading data should be obtained from either<sup>37</sup> a required duplicate instrument, or from a source independent of required flight and navigation instrument systems, or a combination thereof. No connection should be made within the case itself of the altimeter indicators. If data are obtained from an independent source, such source should provide data which has an accuracy equivalent to corresponding data furnished by required flight and navigation instrument systems. Provisions need not be made to disconnect or isolate the recorder in flight from

<sup>35</sup> An electric utilization system is a system of electric equipment devices and connected wiring, which utilizes electric energy to perform a specific aircraft function. The system includes all electric components beyond the nearest bus or sub-bus from which electric energy is supplied. Examples of such systems are: propeller control system, electric flight instrument system, radio navigation equipment system, fuel valve control system, flap and landing gear actuating systems.

<sup>36</sup> A probable malfunction is any single electrical or mechanical malfunction or failure within a utilization system which is considered probable on the basis of past service experience with similar components in aircraft applications. This definition should be extended to multiple malfunctions when: (1) The first malfunction would not be detected during normal operation of the system, including periodic checks established at intervals which are consistent with the degree of hazard involved or (2) the first malfunction would inevitably lead to other malfunctions. This definition of "probable malfunction" applies wherever this term is used in this section.

<sup>37</sup> See section 4b.612(f) for requirements concerning the connection of additional instruments to required duplicate and duplicated instrument systems.

sources of data which are independent of required flight and navigation instruments.

(d) *Connection to electrical power.* The flight recorder should be connected to a bus of maximum reliability when such connection does not jeopardize service to essential or emergency loads. If service to such loads is affected, the recorder should be connected to a bus of the next lower reliability.

(23 F. R. 2728, Apr. 24, 1958, effective May 5, 1958; amended in 23 F. R. 7482, Sept. 26, 1958, effective Oct. 20, 1958.)

### Instruments; Installation

**4b.610 General.** The provisions of sections 4b.611 through 4b.613 shall apply to the installation of instruments.

**NOTE:** It may be necessary to duplicate certain instruments at two or more crew stations to meet the instrument visibility requirements prescribed in section 4b.611, or when required by the operating rules of the Civil Air Regulations for reliability or cross-check purposes in particular types of operations. In the latter case, independent operating systems would be required in accordance with the provisions of section 4b.612 (f).

**4b.611 Arrangement and visibility of instrument installations.**

(a) **Flight, navigation, and powerplant instruments for use by each pilot shall be plainly visible to him from his station with the minimum practicable deviation from his normal position and line of vision when he is looking out and forward along the flight path.**

(b) **Flight instruments required by section 4b.603 shall be grouped on the instrument panel and centered as nearly as practicable about the vertical plane of the pilot's forward vision. The four basic instruments specified in subparagraphs (1) through (4) of this paragraph shall be located on the flight instrument panel as follows:**

(1) **The top center position on the panel shall contain that instrument which, of all instruments on the panel, most effectively indicates attitude.**

(2) **The position adjacent to and directly to the left of the top center position shall contain that instrument, which, of all instruments on the panel, most effectively indicates air speed.**

(3) **The position adjacent to and directly**

**to the right of the top center position shall contain that instrument which, of all instruments on the panel, most effectively indicates altitude.**

(4) **The position adjacent to and directly below the top center position shall contain that instrument which, of all instruments on the panel, most effectively indicates direction of flight.**

(c) **All the required powerplant instruments shall be closely grouped on the instrument panel.**

(d) **Identical powerplant instruments for the several engines shall be located to prevent any misleading impression as to the engines to which they relate.**

(e) **Powerplant instruments vital to the safe operation of the airplane shall be plainly visible to the appropriate crewmembers.**

(f) **The vibration characteristics of the instrument panel shall be such as not to impair seriously the accuracy of the instruments or to damage them.**

**4b.611-1 Procedure for checking arrangement and visibility of instrument installations (FAA policies which apply to sec. 4b.611).** The arrangement and visibility of the instruments should be checked throughout the type tests in order to supply the information which is necessary to complete the pertinent portions of Form FAA 283-4b, Type Inspection Report.

(19 F. R. 4466, July 20, 1954, effective Sept. 1, 1954.)

**4b.612 Flight and navigational instruments.**

(a) **Airspeed indicating systems.**

(1) **Airspeed indicating instruments shall be of an approved type and shall be calibrated to indicate true airspeed at sea level in the standard atmosphere with a minimum practicable instrument calibration error when the corresponding pitot and static pressures are applied to the instrument.**

(2) **The airspeed indicating system shall be calibrated to determine the system error, i. e., the relation between IAS and CAS, in flight and during the accelerated takeoff ground run. The ground run calibration shall be obtained from 0.8 of the minimum value of  $V_1$  to the maximum value of  $V_2$ , taking into account the approved altitude and weight range for the airplane. In the ground run calibration,**

the flap and power settings shall correspond with the values determined in the establishment of the takeoff path under the provisions of section 4b.116, assuming the critical engine to fail at the minimum approved value of  $V_1$ .

(3) The airspeed error of the installation, excluding the airspeed indicator instrument calibration error, shall not exceed 3 percent or 5 mph, whichever is the greater, throughout the speed range from  $[V_{MO}]$  to  $1.3 V_{S1}$  with flaps retracted, and from  $1.3 V_{S0}$  to  $V_{FB}$  with flaps in the landing position.

(4) The airspeed indicating system shall be arranged in so far as practicable to preclude malfunctioning or serious error due to the entry of moisture, dirt, or other substances.

(5) The airspeed indicating system shall be provided with a heated pitot tube or equivalent means of preventing malfunctioning due to icing.

(6) Where duplicate airspeed indicators are required, their respective pitot tubes shall be spaced apart to avoid damage to both tubes in the event of a collision with a bird.

(b) *Static air vent and pressure altimeter systems.*

(1) All instruments provided with static air case connections shall be vented to the outside atmosphere through an appropriate piping system.

(2) The vent(s) shall be so located on the airplane that its orifices will be least affected by airflow variation, moisture, or other foreign matter.

(3) The installation shall be such that the system will be airtight, except for the vent into the atmosphere.

(4) Pressure altimeters shall be of an approved type and shall be calibrated to indicate pressure altitude in standard atmosphere with a minimum practicable instrument calibration error when the corresponding static pressures are applied to the instrument.

(5) The design and installation of the altimeter system shall be such that the error in indicated pressure altitude at sea level in standard atmosphere, excluding instrument calibration error, does not result in a value more than the  $\pm 30$  feet per 100 knots in speed for the appropriate configuration in the speed range between  $1.3 V_{S0}$  (flaps extended) and

$1.8 V_{S1}$  (flaps retracted), except that the error need not be less than  $\pm 30$  feet.

(c) *Magnetic direction indicator.*

(1) The magnetic direction indicator shall be installed so that its accuracy will not be excessively affected by the airplane's vibration or magnetic fields of a permanent or transient nature.

(2) After the magnetic direction indicator has been compensated, the calibration shall be such that the deviation in level flight does not exceed  $\pm 10^\circ$  on any heading.

(3) A calibration placard shall be provided as specified in section 4b.733.

(d) *Automatic pilot system.* If an automatic pilot system is installed, it shall be of an approved type, and the following shall be applicable:

(1) The system shall be so designed that the automatic pilot can be quickly and positively disengaged by the human pilots to prevent it from interfering with their control of the airplane.

(2) A means shall be provided to indicate readily to the pilot the alignment of the actuating device in relation to the control system which it operates, except when automatic synchronization is provided.

(3) The manually operated control(s) for the system's normal operation shall be readily accessible to the pilots. The quick release (emergency) controls shall be installed on both the pilots' control wheels, on the side of the wheel opposite from the throttles. Attitude controls shall operate in the same plane and sense of motion as specified for the cockpit controls in section 4b.353 (b) and Figure 4b-16. The direction of motion shall be plainly indicated on or adjacent to each control.

(4) The automatic pilot system shall be of such design and so adjusted that, within the range of adjustment available to the human pilot, it cannot produce hazardous loads on the airplane or create hazardous deviations in the flight path under any conditions of flight appropriate to its use either during normal operation or in the event of malfunctioning, assuming that corrective action is initiated within a reasonable period of time.

(5) When the automatic pilot integrates signals from auxiliary controls or furnishes

signals for operation of other equipment, positive interlocks and sequencing of engagement shall be provided to preclude improper operation. Protection against adverse interaction of integrated components resulting from a malfunction shall be provided.

(e) *Instruments utilizing a power supply.* The following shall apply to each instrument required in section 4b.603(f), (g), and (h) which utilizes a power supply:

(1) Each instrument shall have a visual type of power failure indicating means, integral with or located adjacent to the instrument, to indicate when adequate power is not being supplied to the instrument (see note) to sustain proper instrument performance. The power shall be sensed at or near the point where power enters the instrument. For electric instruments power shall be deemed adequate when voltage is between approved limits.

(2) Each instrument shall be provided with two independent sources of power and a means of selecting either power source. When duplicate independent instruments are installed, power source selection need not be provided if each instrument has an independent power source.

(3) The installation and power supply system shall be such that failure of one instrument, or the energy supply from one source, or a fault in any part of the power distribution system, will not interfere with the proper supply of energy from the other source. (See also secs. 4b.606(c) and 4b.623.)

*Note:* The word "instrument" as used herein includes those devices which are physically contained in one unit and those devices which are composed of two or more physically separate units or components connected together; such as a remote indicating gyroscopic direction indicator which includes a magnetic sensing element, a gyroscopic unit, an amplifier, and an indicator connected together.

[(f) *Duplicate instrument systems.* If duplicate flight instruments are required by the operating parts of the Civil Air Regulations (see note under sec. 4b.610), the provisions of subparagraphs (1) through (3) of this paragraph shall apply.

[(1) The operating system for flight instruments used by the first pilot, which are required to be duplicated at other flight crew stations,

shall be completely independent of the operating system provided for other flight crew stations.

[(2) Only the required flight instruments and duplicates of required instruments provided for use of the first pilot shall be connected to the operating system provided for the first pilot.

[(3) When other than required instruments and duplicates are connected to other than the first pilot's operating system, provision shall be made to disconnect or isolate in flight such other instruments.]

[Amendment 4b-12, published 27 F. R. 2986, Mar. 30, 1962, effective May 30, 1962.]

4b.612-1 *Airspeed indicating system calibration (FAA policies which apply to sec. 4b.612 (a)).*

(a) *Methods.* Unless a calibrated referenced airspeed system is provided, the airplane's system should be calibrated throughout as wide a range as necessary to cover the intended flight tests. The tests in paragraph (c) of this section are for the purpose of showing compliance with section 4b.612(a) and not intended to cover the speed range of the flight tests. If an alternate airspeed indicating system is provided, it should also be calibrated. The airspeed indicating system should be calibrated in accordance with the following methods:

(1) The tests should be conducted in stabilized flight at airspeeds throughout the speed range for the airplane configurations to be tested. The airplane's airspeed indicator should be calibrated against a reference airspeed system or against a groundspeed course.

(2) A reference airspeed system should consist of either of the following:

(i) An airspeed impact pressure and static pressure measurement device or devices that are free from error due to airplane angular changes relative to the direction of the free stream or due to slipstream variation resulting from changes in airplane configuration or power. In addition the device or devices should have a known calibration error when located in the free stream, or

(ii) Any other acceptable airspeed calibration method, for example, the altimeter method of airspeed calibration. However, when using the altimeter method care should be exercised to measure the airplane's altitude accurately—especially at speeds below 125 m. p. h.

(3) When establishing the airplane's true airspeed by means of the groundspeed course, flight between the two reference points should be made at constant airspeed in two successive runs in opposite directions to eliminate the effect of wind. The runs should be made only in stable wind. The time to make the runs should be obtained by means of some calibrated device. The speed runs should not be made nearer the ground surface than a wing span's length.

(4) If an alternate system is provided it may be calibrated against either the reference system or the airplane's system.

(b) *Configuration.* Airspeed calibration tests should be conducted in the configurations that follow:

Weight—between maximum takeoff and maximum landing.

C. G. position—optional.

Wing flaps and landing gear retracted.

Wing flaps in landing position and landing gear extended.

Engines—optional power.

Mixture setting—optional.

Cowl flaps—optional.

(c) *Test procedure and required data.* Any one or any desired combination of the procedures in subparagraphs (1) through (3) of this paragraph may be used for calibrating the airspeed instrument. The airspeed should be measured or determined simultaneously from the airplane's and the reference system during stabilized runs for at least five speeds spaced throughout the speed range, the lowest not to exceed  $1.3 V_{s1}$ . The highest speed should not exceed  $V_{NO}$ , placard speed, or speed in level flight using maximum continuous power, whichever is lower. The speed spread between the test speeds should be limited to 10 m.p.h. from  $1.3 V_{s1}$  to  $1.6 V_{s1}$  or placard speed, and 30 m.p.h. from  $1.6 V_{s1}$  to  $V_{NO}$ .

(1) *Speed course.* The airspeed and altitude should be stabilized before entering the speed course. Constant airspeed should be maintained during each run. The runs should be made in both directions for each speed over the speed course. The following data should be recorded:

Time of day at beginning of run.

Time to make run.

Pressure altitude.

Ambient air temperature.

Airspeed at several intervals during run.

Wing flap position.

Landing gear position.

Course distance.

(2) *Reference airspeed system.* Stabilized runs at the test speeds listed in this paragraph should be made. The airspeed from the airplane's airspeed system and the reference airspeed system should be read simultaneously. The following data should be recorded:

Time of day.

Airplane's indicated airspeed.

Reference indicated airspeed.

Pressure altitude.

Ambient air temperature.

Wing flap position.

Landing gear position.

(3) *Other acceptable airspeed calibration methods.* Stabilized flight runs at the test speeds should be made and the necessary data recorded to establish the airplane's airspeed system error and the configuration of the airplane.

(19 F. R. 4466, July 20, 1954, effective Sept. 1, 1954; amended 20 F.R. 2280, Apr. 8, 1955, effective Apr. 30, 1955; further amended 20 F. R. 6677, Sept. 10, 1955, effective Sept. 30, 1956.)

4b.612-2 *Static air vent system (FAA policies which apply to sec. 4b.612 (b)).*

(a) If the altimeter installation is of the pressure type its operation will be affected by any error that exists in the static air pressure. Since the accuracy of the altimeter is of utmost importance the static air vent system should be calibrated. If separate or alternate vent systems are employed for the altimeter and airspeed indicator, separate calibrations are required. Where the altimeter, rate of climb indicator, and airspeed indicators are vented to the same static systems, the altimeter calibration may be made in conjunction with the airspeed calibrations.

(b) The theoretical relationship between airspeed error and altimeter error is given in Figure 4 so that an altimeter calibration may be derived from the airspeed calibration if both use the same static vent provided that the total



head installation is such as to provide true readings over the range of angles involved.

(19 F. R. 4466, July 20, 1954, effective Sept. 1, 1954.)

4b.612-3 *Calibration of magnetic direction indicator (FAA policies which apply to sec. 4b.612 (c)).* It is recommended that the magnetic direction indicator be calibrated while the airplane is on the ground with its engines and electrical equipment operating. The calibration data should be included in Form FAA-283-4b.

(19 F. R. 4466, July 20, 1954, effective Sept. 1, 1954.)

4b.612-4 *Automatic pilot systems (FAA policies which apply to sec. 4b.612 (d)).* To preclude hazardous conditions which may result from any failure or malfunctioning of the automatic pilot system, or its inadvertent use by the human pilot, the conditions of paragraphs (a) through (e) and paragraph (h) of this section should be investigated by flight test.

(a) A signal about any axis equivalent to the cumulative effect of any single failure (or if multiple axis failures can result from the malfunction of any single component, combined signals about all affected axes) should be induced into the automatic pilot system during normal climb,<sup>38</sup> cruise, and descent regimes. When corrective action is taken 3 seconds after the airplane response<sup>39</sup> to the malfunction neither the simulated failure nor the subsequent corrective action should create loads beyond an envelope of 0 to 2 g, or speeds beyond  $[V_{FC}$  (or  $M_{FC}$ )] where appropriate), or dangerous deviations from the flight path, except that the positive g limitation may be increased up to the positive design maneuvering load factor if it has previously been determined analytically that neither the simulated failure nor subsequent corrective action would result in loads beyond the design limit loads of the airplane.

(1) Recovery should be demonstrated either by overpowering or by manual use of an emergency quick disconnect device after the 3-second delay. The pilot should be able to

return the airplane to its normal flight attitude under full manual control without exceeding the loads or speed limits defined in this paragraph and without engaging in any dangerous maneuvers during recovery. If an emergency quick disconnect button is not installed on the control wheel it should be possible to overpower servo forces plus resultant airloads in all configurations and attitudes of flight demonstrated, including maximum speed for which approval is sought, without exceeding the following control forces measured at the pilot's controls: pitch 50 pounds; roll 30 pounds (force applied at rim); yaw 150 pounds. The maximum altitude loss experienced during these tests should be entered in the Airplane Flight Manual under "Emergency Operating Procedures."

(b) The automatic pilot system should be able to perform its intended function throughout all appropriate maneuvers. All such maneuvers should be accomplished smoothly and without subjecting the airplane to loads greater than those described in paragraph (a) of this section.

(c) If the automatic pilot system includes an approach coupler it should be able to perform its intended function, and the following should apply:

(1) Throughout an approach no signal or combination of signals simulating the cumulative effect of any single failure or malfunction in the automatic pilot system should produce hazardous deviations in the flight path or any degree of loss of control if corrective action is initiated one second after the airplane responds to the malfunction.

(i) The airplane should be flown down the ILS (or along a flight path simulating the ILS) in the approach configuration. At a predetermined point a failure should be induced in the automatic pilot system. One second after the airplane responds to the malfunction, the pilot should take corrective action by either overpowering or manually disconnecting the automatic pilot (utilizing the emergency quick disconnect button on the control wheel). The vertical distance below the glide path, measured from the point at which level flight is regained, should be entered in the Airplane Flight Manual under "Emergency Operating Procedures."

<sup>38</sup> The configuration for normal climb will be that for operational all-engine climb with 75 percent maximum continuous power and flaps retracted.

<sup>39</sup> Adequate instrumentation should be installed to register response of the airplane to the induced malfunction. One acceptable method would be by measurement of airplane acceleration.

(2) An engine failure during a normal ILS approach should not cause a lateral deviation of the airplane from the flight path at a rate greater than three degrees per second.

(3) If approval is sought for ILS approaches initiated with one engine inoperative, the automatic pilot should be capable of conducting the approach, and the provisions of subparagraph (1) of this paragraph should be complied with.

(4) A visual means should be provided between the automatic pilot and the flight path coupler to indicate to the pilot when the automatic pilot is uncoupled from the airborne navigational reference.

(d) For an automatic pilot without an approach coupler, where the applicant desires approval for low approaches, the conditions outlined in paragraph (c) (1), (2), and (3) of this section should apply.

(e) If an automatic trim system is incorporated into the automatic pilot, it should be so designed and installed that any failure will not create a hazardous condition to either automatic or manual flight.

(f) When an emergency quick disconnect device is installed on the automatic pilot, the release buttons should be located on both the pilot's and copilot's control wheels, on the side of the wheel opposite from the throttles.

(g) The automatic pilot system should be so installed that its operation will not be adversely affected by spurious signals from other sources, or as a result of normal variations in the automatic pilot system power source, or feedback by other equipment operating from the same power source (see secs. 4b.625 (b) and 4b.650 (c)).

(h) The automatic pilot system should be so installed and adjusted that the servo stall forces established during certification tests can be maintained in normal operation. This may be assured by conducting flight tests throughout the envelope of servo stall forces. Those tests conducted to determine that the automatic pilot system will adequately control the aircraft should establish the lower stall force limit; and those tests to determine that the automatic pilot will not impose dangerous loads or deviations from the flight path should be conducted at the upper stall force limit.

(i) A positive means should be provided to indicate to the pilot when the automatic pilot is ready for operation or when the gyroscopic components are uncaged, unless it is impossible (as a result of design features) to engage the automatic pilot before it is ready for operation.

(j) The following information should be placed on the Aircraft Specification:

(1) Servo motor and gear train model numbers.

(2) Servo unit pulley sizes.

(3) Upper and lower limiting stall forces measured at the servo motors.

(k) The following information should be placed in the Airplane Flight Manual:

(1) Under the operating limitations section, airspeed limitations and other applicable operating limitations.

(2) Under the operating procedures section, normal operation information.

(3) Under the emergency operating procedures section, a statement of altitude lost in the cruising configuration (see paragraph (a) (1) of this section); a statement of altitude lost on ILS approaches (see paragraph (c) (1) (i) of this section); and any other applicable emergency procedure information.

(21 F. R. 2124, Apr. 3, 1956, effective Apr. 14, 1956 [amended in 27 F. R. 2986, Mar. 30, 1962, effective May 3, 1962.]

4b.612-5 *Connection of additional instruments to duplicate instrument system (FAA policies which apply to sec. 4b.612 (f)).* Neither the accuracy nor the performance of any required duplicate instrument should be reduced below the minimum required by the pertinent Civil Air Regulations when an additional instrument is connected to or is subsequently disconnected from the system.

(23 F. R. 2728, Apr. 24, 1958, effective May 5, 1958; amended in 23 F. R. 7482, Sept 26, 1958, effective Oct. 20, 1958.)

#### 4b.613 *Powerplant instruments.*

##### (a) *Instrument lines.*

(1) **Powerplant instrument lines carrying flammable fluids or gases under pressure shall be provided with restricted orifices or equivalent safety devices at the source of the pressure to prevent the escape of excessive fluid or gas in case of line failure.**

(2) The provisions of sections 4b.432 and 4b.433 shall be made applicable to powerplant instrument lines.

(b) *Fuel quantity indicator.* Means shall be provided to indicate to the flight crew the quantity in gallons or equivalent units of usable fuel in each tank during flight. The following shall apply:

(1) Tanks, the outlets and airspaces of which are interconnected, shall be considered as one tank for the purpose of providing separate indicators.

(2) Exposed sight gauges shall be protected against damage.

(3) Fuel quantity indicators shall be calibrated to read zero during level flight when the quantity of fuel remaining in the tank is equal to the unusable fuel supply as defined by section 4b.416 (see sec. 4b.736).

(c) *Fuel flowmeter system.* When a flowmeter system is installed, the metering component shall include a means for bypassing the fuel supply in the event that malfunctioning of the metering component results in a severe restriction to fuel flow.

(d) *Oil quantity indicator.*

(1) A stick gauge or other equivalent means shall be provided to indicate the quantity of oil in each tank. (See sec. 4b.735.)

(2) If an oil transfer system or a reserve oil supply system is installed, means shall be provided to indicate to the crew during flight the quantity of oil in each tank.

(e) *Turbine-propeller blade position indicating means.* The indicating means required for turbine propellers by section 4b.604 (s) shall initiate indication before the propeller blade has moved more than eight degrees below the flight low pitch stop. The source of the indication shall sense blade position directly.

(f) *Fuel pressure indication.*

(1) Provisions shall be made to measure the fuel pressure, in all systems supplying reciprocating engines, at a point downstream of all fuel pumps except fuel injection pumps. (For instrument requirements see sec. 4b.604(e).)

(2) When necessary for the maintenance of the proper fuel delivery pressure, a connec-

tion shall be provided to transmit the carburetor air intake static pressure to the proper fuel pump relief valve connection. In such cases, to avoid erroneous fuel pressure reading, the gauge balance lines shall be independently connected to the carburetor inlet pressure.

## Electrical Systems and Equipment

4b.620 *General.* The provisions of sections 4b.621 through 4b.627 shall apply to all electrical systems and equipment. (See also sec. 4b.606.)

4b.621 *Electrical system capacity.* The required generating capacity and the number and type of power sources shall be determined by an electrical load analysis and shall comply with section 4b.606 (c).

4b.622 *Generating system.*

(a) The generating system shall be considered to include electrical power sources, main power busses, transmission cables, and associated control, regulation, and protective devices.

[(b) The generating system shall be designed so that:

[(1) The power sources function properly when independent and when connected in combination;

[(2) The failure or malfunctioning of any power source cannot create a hazard or impair the ability of the remaining sources to supply essential loads;

[(3) The system voltage and frequency (as applicable) at the terminals of all essential load equipment can be maintained within the limits for which the equipment is designed, during any probable operating condition; and

[(4) System transients initiated by switching, fault clearing, or other causes, do not render essential loads inoperative, and do not introduce a smoke or fire hazard.]

(c) Means accessible in flight to appropriate crewmembers shall be provided for the independent disconnection of each electrical power source from the system. Controls for this purpose shall be grouped to permit expeditious disconnection of electrical power sources.

(d) Means shall be provided to indicate to appropriate crewmembers those generating

system quantities which are essential for the safe operation of the system.

**NOTE:** The voltage and current supplied by each generator are quantities considered essential.

[(Amendment 4b-12, published 27 F. R. 2986, Mar. 30, 1962, effective May 3, 1962.)]

4b.622-1 *Generating system reliability (FAA policies which apply to sec. 4b.622 (b)).* Generating systems should be analyzed, inspected, or tested to assure conformance to the following reliability criteria:

(a) *Failure of propulsion engines or other prime movers.* The generating system performance (after failure of one or more propulsion engines or other prime movers) should be that specified in section 4b.606 (c).

(b) *Generating system malfunctions.* No probable malfunction<sup>40</sup> in the generating system, or in the generator drive system,<sup>41</sup> should result in the permanent loss of service to electric utilization systems<sup>42</sup> which are necessary to maintain controlled flight and to effect a safe landing,<sup>43</sup> unless the aircraft is equipped with an independent source of electric power capable of supplying continuous emergency service to these utilization systems.

(c) *Corrective action.* Where corrective action is necessary to comply with paragraphs (a) and (b) of this section.

(1) Adequate warning should be provided for any malfunction or failure requiring such corrective action.

(2) Controls should be so located as to permit such corrective action during any probable flight situation.

(3) If corrective action must be taken within a specified time interval for continued

safe operation of the generating system, it should be demonstrated that such corrective action can be accomplished within the specified time interval during any probable flight situation.

(4) The procedure to be followed by the crew should be detailed in the Operating Procedures Section of the Airplane Flight Manual (see sec. 4b.740).

(d) *Electric system smoke and fire procedures (see sec. 4b.371 (c)).* To cope with electrical smoke or fire of undetermined origin, generating system controls should be designed to permit electrical disconnection of overheated equipment in flight without hazardous interruption of service to electric utilization systems. Procedures for this purpose should be contained in the Operating Procedures Section of the Airplane Flight Manual (see sec. 4b.740).

(22 F. R. 6885, Aug. 27, 1957, effective Sept. 15, 1957.)

#### 4b.623 *Distribution system.*

(a) The distribution system shall be considered to include all distribution busses, their associated feeders, and control and protective devices.

(b) Individual distribution systems shall be designed to insure that essential load circuits can be supplied in the event of reasonably probable faults or open circuits.

(c) Where two independent sources of electrical power for particular equipment or systems are required by the Civil Air Regulations, their electrical energy supply shall be assured.

**NOTE:** Various means may be used to assure a supply, such as duplicate electrical equipment, throw-over switching, and multi-channel or loop circuits separately routed.

#### 4b.624 *Electrical protection.*

(a) Automatic protective devices shall be provided to minimize distress to the electrical system and hazard to the airplane in the event of wiring faults or serious malfunctioning of the system or connected equipment.

(b) In the generating system the protective and control devices shall be such as to de-energize and disconnect faulty power sources and power transmission equipment from their associated busses with sufficient rapidity to provide protection against hazardous over-voltage and other malfunctioning.

<sup>40</sup> A probable malfunction is any single electrical or mechanical malfunction or failure which is considered probable on the basis of past service experience with similar components in aircraft applications. This definition should be extended to multiple malfunctions when: (1) the first malfunction would not be detected during normal operation of the system, including periodic checks established at intervals which are consistent with the degree of hazard involved, or (2) the first malfunction would inevitably lead to other malfunctions.

<sup>41</sup> The generator drive system includes the prime movers (propulsion engines or other) and coupling devices such as gear-boxes or constant-speed drives.

<sup>42</sup> An electric utilization system is a system of electric equipment, devices and connected wiring which utilizes electric energy to perform a specific aircraft function.

<sup>43</sup> The specific electric utilization systems which are necessary to maintain controlled flight and effect a safe landing will vary with the type of aircraft and with the nature of the operation in which the aircraft is utilized. Examples of systems which may be in this category are as follows: basic flight instruments, minimum navigation equipment, minimum two-way radio communications, control system boost.

(c) All resettable type circuit protective devices shall be so designed that when an overload or circuit fault exists, they will open the circuit irrespective of the position of the operating control.

[(d) If the ability to reset a circuit breaker or to replace a fuse is essential to safety in flight, such circuit breaker or fuse shall be so located and identified that it can be readily reset or replaced in flight.]

(e) Circuits for essential loads shall have individual circuit protection.

NOTE: This provision does not necessarily require individual protection for each circuit in an essential load system (e. g., each position light in the system).

(f) If fuses are used, there shall be provided spare fuses for use in flight equal to at least 50 percent of the number of fuses of each rating required for complete circuit protection.

[(Amendment 4b-12, published 27 F. R. 2986, Mar. 1962, effective May 3, 1962.)]

4b.624-1 *Automatic reset circuit breaker (FAA policies which apply to sec. 4b.624).* Automatic reset circuit breakers (which automatically reset themselves periodically) should not be applied as circuit protective devices.<sup>44</sup> They may be used as integral protectors for electrical equipment (e. g., thermal cut-outs) provided that circuit protection is also installed to protect the cable to the equipment.

(20 F. R. 2280, Apr. 8, 1955, effective Apr. 30, 1955.)

#### 4b.625 *Electrical equipment and installation.*

(a) In showing compliance with section 4b.606 (a) and (b) with respect to the electrical system, equipment, and installation, consideration shall be given to critical environmental conditions.

NOTE: Critical environmental conditions may include temperature, pressure, humidity, ventilation, position,

<sup>44</sup> Circuit protective devices are normally installed to limit the hazardous consequences of overloaded or faulted circuits. These devices are resettable (circuit breakers) or replaceable (fuses) to permit the crew to restore service when nuisance trips occur or when the abnormal circuit condition can be corrected in flight. If the abnormal circuit condition cannot be corrected in flight, the decision to restore power to the circuit involves a careful analysis of the flight situation. It is necessary to weigh the essentiality of the circuit for continued safe flight against the hazards of resetting on a possibly faulted circuit. Such evaluation is properly an aircraft crew function which can not be performed by automatic reset circuit breakers. To assure crew supervision over the reset operation, circuit protective devices should be of such design that a manual operation is required to restore service after tripping.

acceleration, vibration, and presence of detrimental substances.

(b) All electrical equipment, controls, and wiring shall be so installed that operation of any one unit or system of units will not affect adversely the simultaneous operation of any other electrical unit or system of units essential to the safe operation of the airplane.

(c) Cables shall be grouped, routed, and spaced so that damage to essential circuits will be minimized in the event of faults in heavy current-carrying cables.

(d) Storage batteries shall be of such design and be so installed that:

(1) Safe cell temperatures and pressures are maintained during any probable charging or discharging condition. No uncontrolled increase in cell temperature shall result when the storage battery is recharged (after previous complete discharge) at maximum regulated voltage, during a flight of maximum duration, under the most adverse cooling conditions likely to occur in service. Tests to demonstrate compliance with this regulation shall not be required if satisfactory operating experience with similar batteries and installations has shown that maintaining safe cell temperatures and pressures presents no problem.

(2) Explosive or toxic gases emitted by the storage battery in normal operation, or as the result of any probable malfunction in the charging system or battery installation, shall not accumulate in hazardous quantities within the airplane.

(3) Corrosive fluids or gases which may be emitted or spilled from the storage battery shall not damage the surrounding airplane structure or adjacent essential equipment.

4b.625-1 *Environmental tests for electrical equipment*<sup>45</sup> (FAA policies which apply to sec. 4b.625 (a)). The ability of electrical equipment to provide continuous safe service under foreseeable environmental conditions may be demonstrated by means of environmental tests, design analyses, or reference to previous comparable service experience on other aircraft.

<sup>45</sup> This policy applies to all electrical generation, distribution, and utilization equipment required by or utilized in complying with the applicable Civil Air Regulations, except those items covered by Technical Standard Orders containing environmental test procedures.

For environmental testing, the test procedures contained in appendix I of this manual are acceptable, subject to the following objective criteria:

(a) The extremes of climatic and environmental conditions given in appendix I may be reduced in specific aircraft applications when it can be shown that these extremes would not be reached in normal service. Conversely, these extremes should be extended when individual applications indicate the need, such as may occur when electrical equipment is exposed to high intensity acoustic noise generated by turbojet engines.

(b) In all cases the ability of the equipment to safely withstand exposure to temperature extremes, temperature shock, humidity, altitude, vibration, flight and normal landing impact shocks, and acceleration should be demonstrated. Tests for each of these conditions are set forth in appendix I. Tests in environments such as sand and dust, fungus and saltspray may be limited to equipment likely to be exposed to these conditions.

(c) Electrical equipment altitude testing should be conducted at an altitude 15 percent above the maximum altitude to which the equipment would be exposed in normal service. However, testing of certain equipment installed in pressurized areas should be under conditions of altitude and time which will assure that, in case of rapid decompression:

(1) Equipment necessary for the execution of an emergency descent would remain operative for the probable period required for such descent.

(2) Other equipment is not rendered permanently inoperative if the operation of the equipment is necessary to maintain controlled flight or effect a safe landing.

(3) No equipment will constitute a hazard due to arcing, fire, or smoke. However, altitude testing for hazard from arcing, fire, or smoke is not required where any hazard is satisfactorily minimized independently of altitude by design and installation features.

(23 F. R. 10325, Dec. 25, 1958, effective Jan. 31, 1959.)

**4b.626 Electrical system fire and smoke protection.** The design and installation of all

components of the electrical system shall be in compliance with pertinent fire and smoke protection provisions of sections 4b.371 (c), 4b.385, and 4b.490. In addition, all electrical cables, terminals, and equipment which are necessary in emergency procedures and which are located in designated fire zones shall be fire-resistant.

4b.626-1 *Fire-resistant electrical equipment*<sup>46</sup> (FAA policies which apply to sec. 4b.626). When applied to the electrical equipment and components defined in the last sentence of section 4b.626, an accepted criterion for "fire resistant" is that such equipment and components, as installed in the aircraft, should withstand a 2000° F. oxidizing flame impinging on their surfaces for at least 5 minutes without adverse effect on their circuit function.<sup>47</sup> The 2000° F. oxidizing flame should envelop the equipment under test, using a test setup simulating the actual aircraft installation.<sup>48</sup> Thermocouples for measurement of flame temperature should be located within one-fourth inch of the surface exposed to the flame.

(22 F. R. 6885, Aug. 27, 1957, effective Sept. 15, 1957; amended in 23 F. R. 2790, Apr. 26, 1958, effective May 5, 1958.)

**[4b.627 Electrical system tests.** When laboratory tests of the electrical system are conducted they shall be performed on a mock-up utilizing the same generating equipment complement as in the aircraft. The equipment shall simulate the electrical characteristics of the distribution wiring and connected loads to the extent necessary for valid test results. Laboratory generator drives shall simulate the actual prime movers on the airplane with respect to their reaction to generator loading, including loading due to faults. When the conditions of flight cannot adequately be simulated in the laboratory or by ground tests on the

<sup>46</sup> This policy establishes a basic test standard for fire-resistant electrical equipment located in designated fire zones. However, installation approval may be granted for equipment which does not conform to this standard, if it can be shown that such equipment would provide equivalent safety if exposed to the probable fire conditions at its particular location.

<sup>47</sup> Excessive temperature may affect electrical equipment and components by causing such malfunctions as short circuit, open circuit, and changes in circuit parameters (for example, reduced insulation resistance and dielectric strength).

<sup>48</sup> In the case of electric cable, only a representative length, not less than 12 inches, need be enveloped in the flame.

prototype airplane, flight tests shall be conducted.]

[(Amendment 4b-12, published 27 F. R. 2986, Mar. 30, 1962, effective May 3, 1962.)]

**4b.628 Lightning strike protection.** Those portions of the airplane which are electrically insulated from the main body of the airplane shall be connected to the basic airframe through appropriate lightning arrestors, unless it is shown that a lightning strike on the insulated portion is improbable because of the shielding afforded by other portions of the airplane, or unless it is shown that a lightning strike on the insulated portion would not create a hazard to the airplane or its occupants.

### Lights <sup>AMD. 4b-11</sup>

#### 4b.630 Instrument lights.

(a) Instrument lights shall provide sufficient illumination to make all instruments, switches, etc., easily readable.

(b) Instrument lights shall be so installed that their direct rays are shielded from the pilot's eyes and so that no objectionable reflections are visible to him.

(c) A means of controlling the intensity of illumination shall be provided, unless it is shown that nondimmed instrument lights are satisfactory under all expected conditions of flight.

#### 4b.631 Landing lights.

(a) Landing lights shall be of an approved type.

(b) Landing lights shall be installed so that there is no objectionable glare visible to the pilot and so that the pilot is not adversely affected by halation.

(c) Landing lights shall be installed in a location where they provide the necessary illumination for night landing.

(d) A switch for each light shall be provided, except that where multiple lights are installed at one location a single switch for the multiple lights shall be acceptable.

(e) A means shall be provided to indicate to the pilots when the landing lights are extended.

#### 4b.632 Position light system installation.

(a) *General.* The provisions of sections 4b.632 through 4b.635 shall be applicable to

the position light system as a whole. The position light system shall include the items specified in paragraphs (b) through (d) of this section.

(b) *Forward position lights.* Forward position lights shall consist of a red and a green light spaced laterally as far apart as practicable and installed forward on an airplane in such a location that, with the airplane in normal flying position, the red light is displayed on the left side and the green light is displayed on the right side. The individual lights shall be of an approved type.

(c) *Rear position light.* The rear position light shall consist of a white light mounted on the airplane as far aft as practicable. The light shall be of an approved type.

(d) *Light covers and color filters.* Light covers or color filters used shall be of flame-resistant material and shall be constructed so that they will not change color or shape or suffer any appreciable loss of light transmission during normal use.

4b.632-1 *Red passing lights (FAA policies which apply to sec. 4b.632 (a)).* When it is desired to improve the conspicuity of the aircraft a steady red light, commonly known as a passing light, may be installed. This light is not considered to be a position light and therefore need not be type certificated. When installed, its location should be one of the following:

(a) Within the left landing light unit.

(b) On the centerline of the aircraft nose.

(c) In the leading edge of the left wing, outboard of the propeller disc.

(16 F. R. 3212, Apr. 12, 1951, effective Apr. 15, 1951.)

**4b.633 Position light system dihedral angles.** The forward and rear position lights as installed on the airplane shall show unbroken light within dihedral angles specified in paragraphs (a) through (c) of this section.

(a) Dihedral angle L (left) shall be considered formed by two intersecting vertical planes, one parallel to the longitudinal axis of the airplane and the other at 110° to the left of the first, when looking forward along the longitudinal axis.

(b) Dihedral angle R (right) shall be considered formed by two intersecting vertical planes, one parallel to the longitudinal axis of

the airplane and the other at 110° to the right of the first, when looking forward along the longitudinal axis.

(c) Dihedral angle A (aft) shall be considered formed by two intersecting vertical planes making angles of 70° to the right and 70° to the left, respectively, looking aft along the longitudinal axis, to a vertical plane passing through the longitudinal axis.

**4b.634 Position light distribution and intensities.**

(a) *General.* The intensities prescribed in this section are those to be provided by new equipment with all light covers and color filters in place. Intensities shall be determined with the light source operating at a steady value equal to the average luminous output of the light source at the normal operating voltage of the airplane. The light distribution and intensities of position lights shall comply with the provisions of paragraphs (b) and (c) of this section.

(b) *Forward and rear position lights.* The light distribution and intensities of forward and rear position lights shall be expressed in terms of minimum intensities in the horizontal plane, minimum intensities in any vertical plane, and maximum intensities in overlapping beams, within dihedral angles L, R, and A, and shall comply with the provisions of subparagraphs (1) through (3) of this paragraph.

(1) *Intensities in horizontal plane.* The intensities in the horizontal plane shall not be less than the values given in figure 4b-18. (The horizontal plane is the plane containing the longitudinal axis of the airplane and is perpendicular to the plane of symmetry of the airplane).

(2) *Intensities above and below horizontal.* The intensities in any vertical plane shall not be less than the appropriate value given in figure 4b-19, where I is the minimum intensity prescribed in figure 4b-18 for the corresponding angles in the horizontal plane. (Vertical planes are planes perpendicular to the horizontal plane.)

(3) *Overlaps between adjacent signals.* The intensities in overlaps between adjacent signals shall not exceed the values given in figure 4b-20, except that higher intensities in the overlaps shall be acceptable with the use of

main beam intensities substantially greater than the minima specified in figures 4b-18 and 4b-19 if the overlap intensities in relation to the main beam intensities are such as not to affect adversely signal clarity.

Dihedral angle (light involved)	Angle from right or left of longitudinal axis, measured from dead ahead	Intensity (candles)
L and R (forward red and green)-----	0° to 10°	40
	10° to 20°	30
	20° to 110°	5
A (Rear white)-----	110° to 180°	20

Figure 4b-18.—Minimum intensities in the horizontal plane of forward and rear position lights.

Angle above or below horizontal	Intensity
0°-----	1.00 I.
0° to 5°-----	0.90 I.
5° to 10°-----	0.80 I.
10° to 15°-----	0.70 I.
15° to 20°-----	0.50 I.
20° to 30°-----	0.30 I.
30° to 40°-----	0.10 I.
40° to 90°-----	[0.05 I.]

Figure 4b-19.—Minimum intensities in any vertical plane of forward and rear position lights.

Overlaps	Maximum intensity	
	Area A (candles)	Area B (candles)
Green in dihedral angle L-----	10	1
Red in dihedral angle R-----	10	1
Green in dihedral angle A-----	5	1
Red in dihedral angle A-----	5	1
Rear white in dihedral angle L-----	5	1
Rear white in dihedral angle R-----	5	1

NOTE: Area A includes all directions in the adjacent dihedral angle which pass through the light source and which intersect the common boundary plane at more than 10 degrees but less than 20 degrees. Area B includes all directions in the adjacent dihedral angle which pass through the light source and which intersect the common boundary plane at more than 20 degrees.

Figure 4b-20.—Maximum intensities in overlapping beams of forward and rear position lights.

The next figure is Figure 4b-22. (Figure 4b-21 was deleted by Amendment 4b-9.)



4b.634-1 *Overlaps between high intensity forward position lights (FAA policies which apply to sec. 4b.634 (b) (3)).* When the peak intensity of the forward position lights is greater than 100 candles, the maximum overlap intensities between them may exceed the values given in Figure 4b-20 provided the overlap intensity in Area A is not greater than 10 percent of peak position light intensity and the overlap intensity in Area B is not greater than 2.5 percent of peak position light intensity.<sup>49</sup>

(23 F. R. 2790, Apr. 26, 1958, effective May 5, 1958.)

4b.635 *Position light color specifications.* The colors of the position lights shall have the International Commission on Illumination chromaticity coordinates as set forth in paragraphs (a) through (c) of this section.

(a) *Aviation red.*

$y$  is not greater than 0.335,

$z$  is not greater than 0.002;

(b) *Aviation green.*

$x$  is not greater than  $0.440 - 0.320y$ ,

$x$  is not greater than  $y - 0.170$ ,

$y$  is not less than  $0.390 - 0.170x$ ;

(c) *Aviation white.*

$x$  is not less than 0.350,

$x$  is not greater than 0.540,

$y - y_0$  is not numerically greater than 0.01,

$y_0$  being the  $y$  coordinate of the Planckian radiator for which  $x_0 = x$ .

4b.636 *Riding light.*

(a) When a riding (anchor) light is required for a seaplane, flying boat, or amphibian, it shall be capable of showing a white light for at least two miles at night under clear atmospheric conditions.

(b) The riding light shall be installed to show the maximum unbroken light practicable when the airplane is moored or drifting on the water. Externally hung lights shall be acceptable.

4b.637 *Anticollision light system.* An anticollision light system shall be installed which shall consist of one or more approved anticollision lights so located that the emitted light will not be detrimental to the crew's vision and will not detract from the conspicuity of the position lights. The system shall comply with

the provisions of paragraphs (a) through (d) of this section.

(a) *Field of coverage.* The system shall consist of such lights as will afford coverage of all vital areas around the airplane with due consideration to the physical configuration and the flight characteristics of the airplane. In any case, the field of coverage shall extend in all directions within  $30^\circ$  above and  $30^\circ$  below the horizontal plane of the airplane, except that a solid angle or angles of obstructed visibility totaling not more than 0.03 steradians shall be permissible within a solid angle equal to 0.15 steradians centered about the longitudinal axis in the rearward direction.

(b) *Flashing characteristics.* The arrangement of the system, i. e., number of light sources, beam width, speed of rotation, etc., shall be such as to give an effective flash frequency of not less than 40 and not more than 100 cycles per minute. The effective flash frequency shall be the frequency at which the airplane's complete anticollision light system is observed from a distance, and shall apply to all sectors of light including the overlaps which might exist when the system consists of more than one light source. In overlaps, flash frequencies higher than 100 cycles per minute shall be permissible, except that they shall not be higher than 180 cycles per minute.

(c) *Color.* The color of the anticollision lights shall be aviation red in accordance with the specifications of section 4b.635 (a).

(d) *Light intensity.* The minimum light intensities in all vertical planes, measured with the red filter and expressed in terms of "effective" intensities, shall be in accordance with figure 4b-27. The following relation shall be assumed:

$$I_e = \frac{\int_{t_1}^{t_2} I(t) dt}{0.2 + (t_2 - t_1)}$$

where:

$I_e$  = effective intensity (candles),

$I(t)$  = instantaneous intensity as a function of time,

$t_2 - t_1$  = flash time interval (seconds).

NOTE: Normally, the maximum value of effective intensity is obtained when  $t_2$  and  $t_1$  are so chosen that the effective intensity is equal to the instantaneous intensity at  $t_2$  and  $t_1$ .

<sup>49</sup> Overlap intensities should be determined with the position lights installed in their actual airplane locations, since adjacent airplane structure will often provide some cutoff in the overlap area.

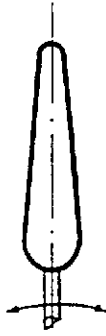
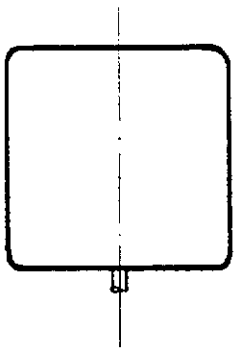

FLAP CONTROL KNOB

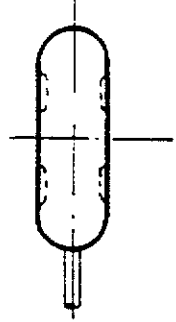
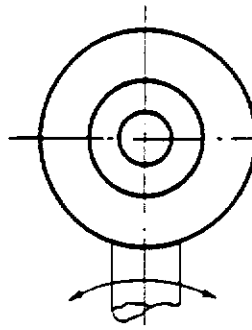

LANDING GEAR CONTROL KNOB

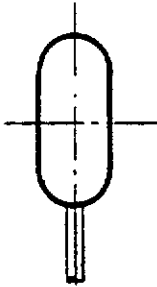
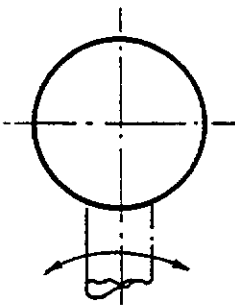

THROTTLE CONTROL KNOB

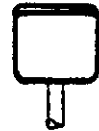
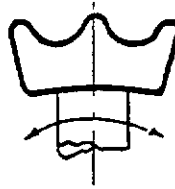

RPM CONTROL KNOB

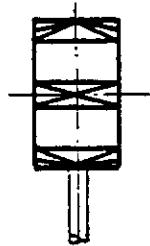
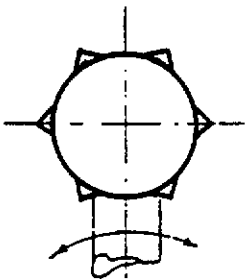

MIXTURE CONTROL KNOB

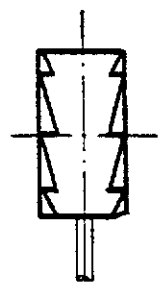
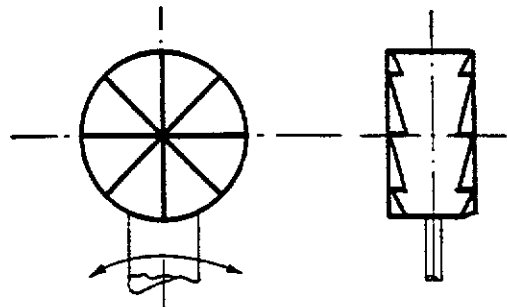

SUPERCHARGER CONTROL KNOB

Figure 4b-22.—Control knob shapes.

The next figure is Figure 4b-24a. (Figure 4b-23 was deleted by Amendment 4b-7.)

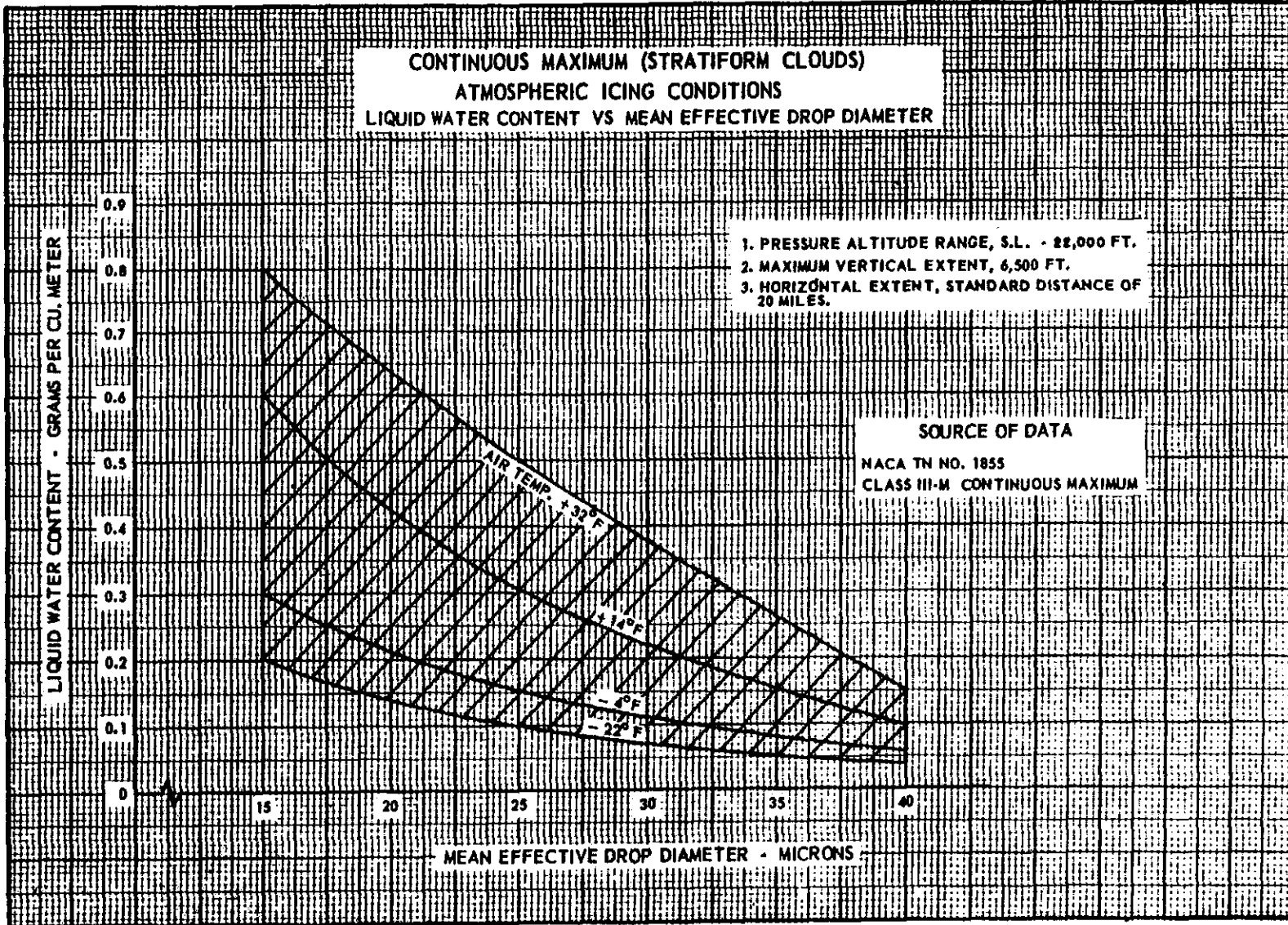

Figure 4b-24a.

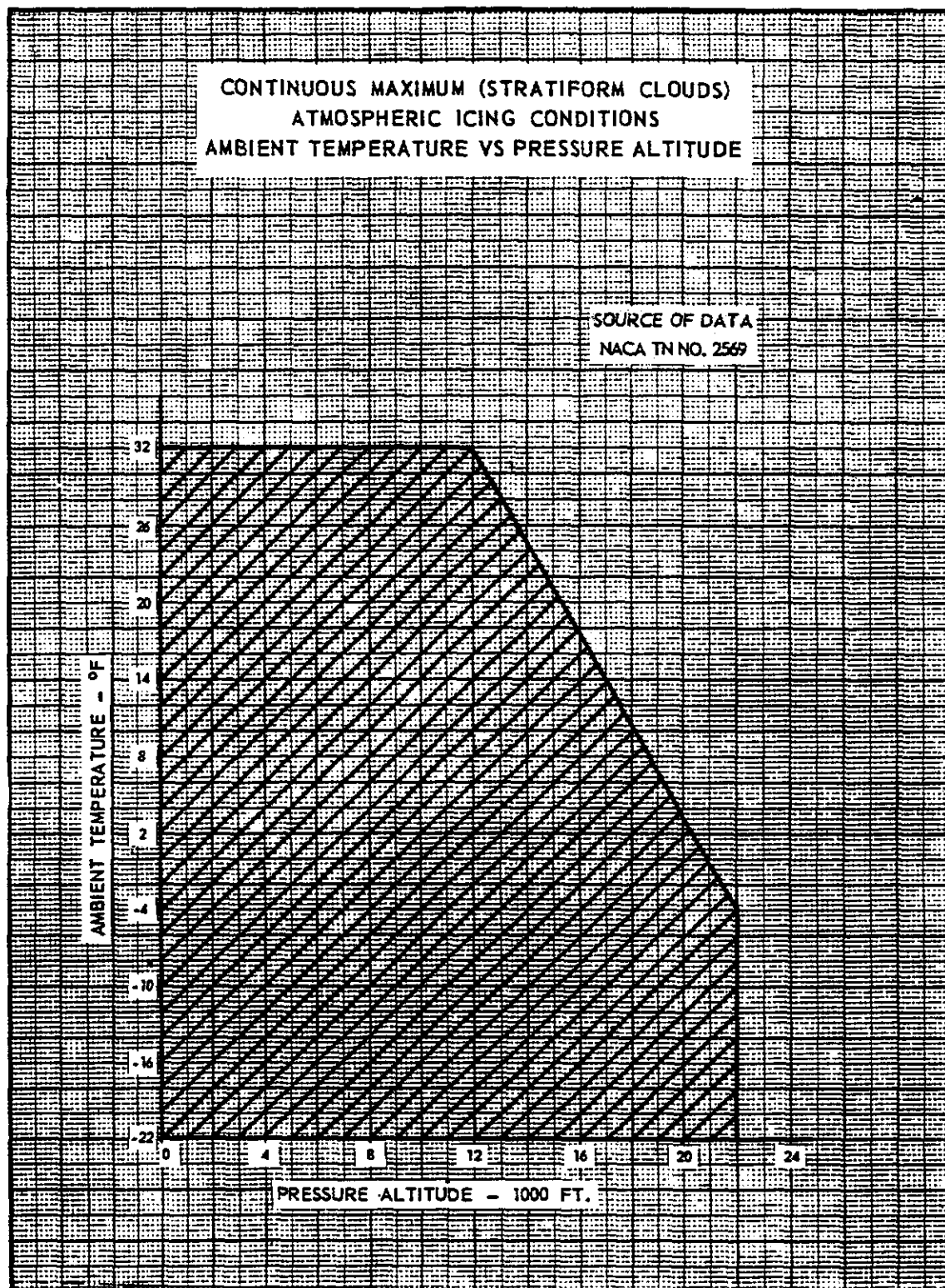

Figure 4b-24b.

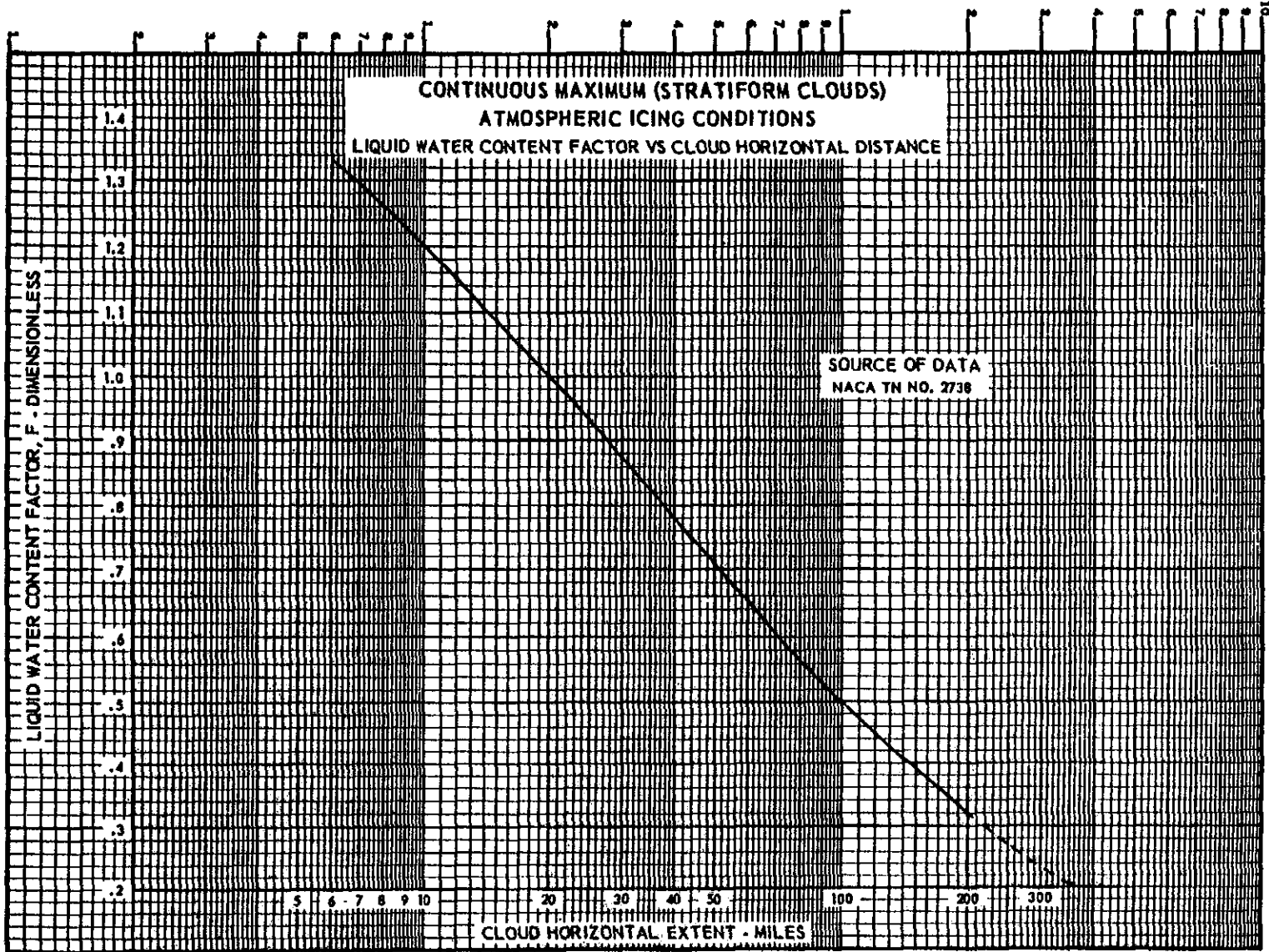

Figure 4b-24c.

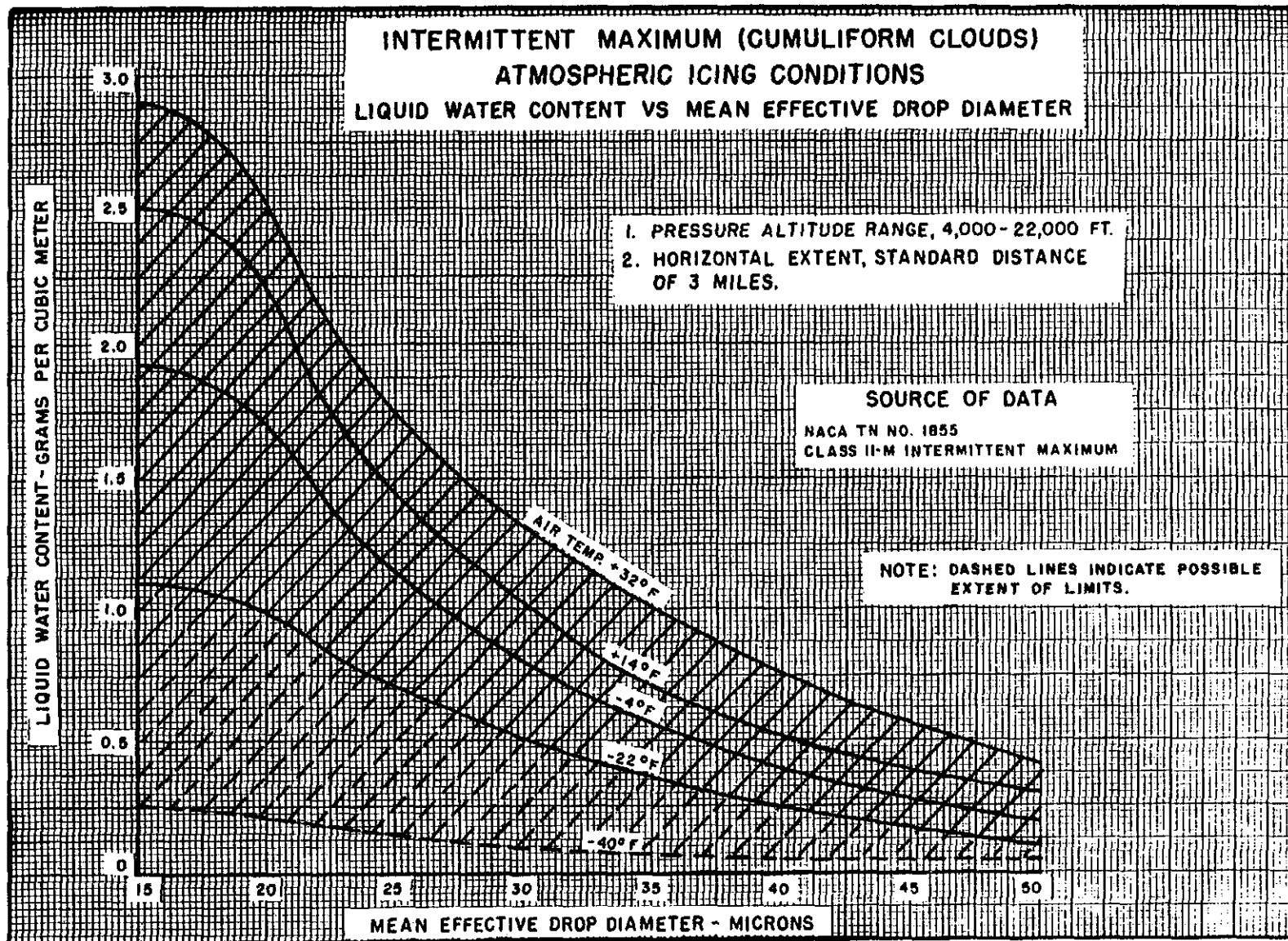

Figure 4b-25a.

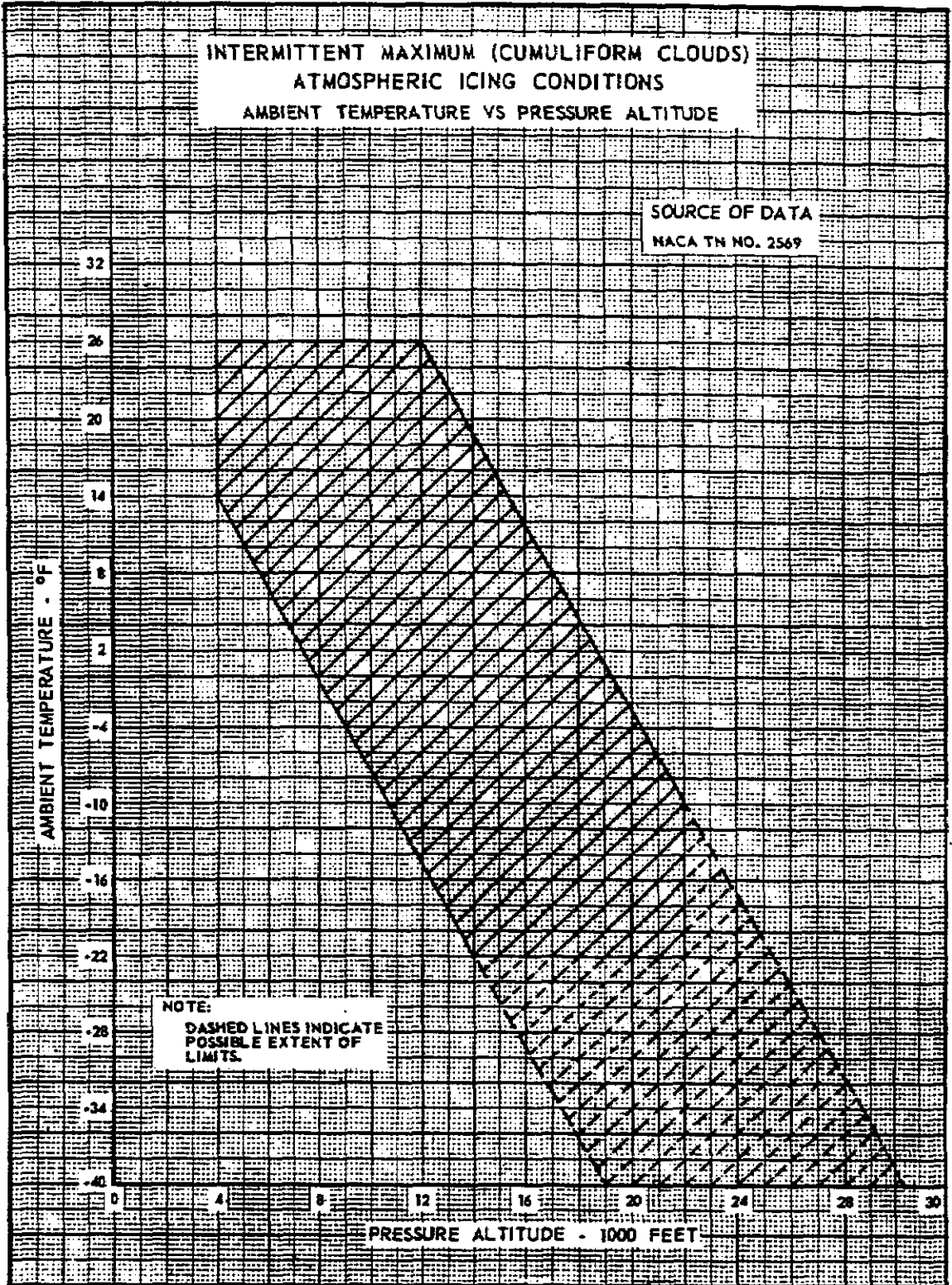

Figure 4b-25b.

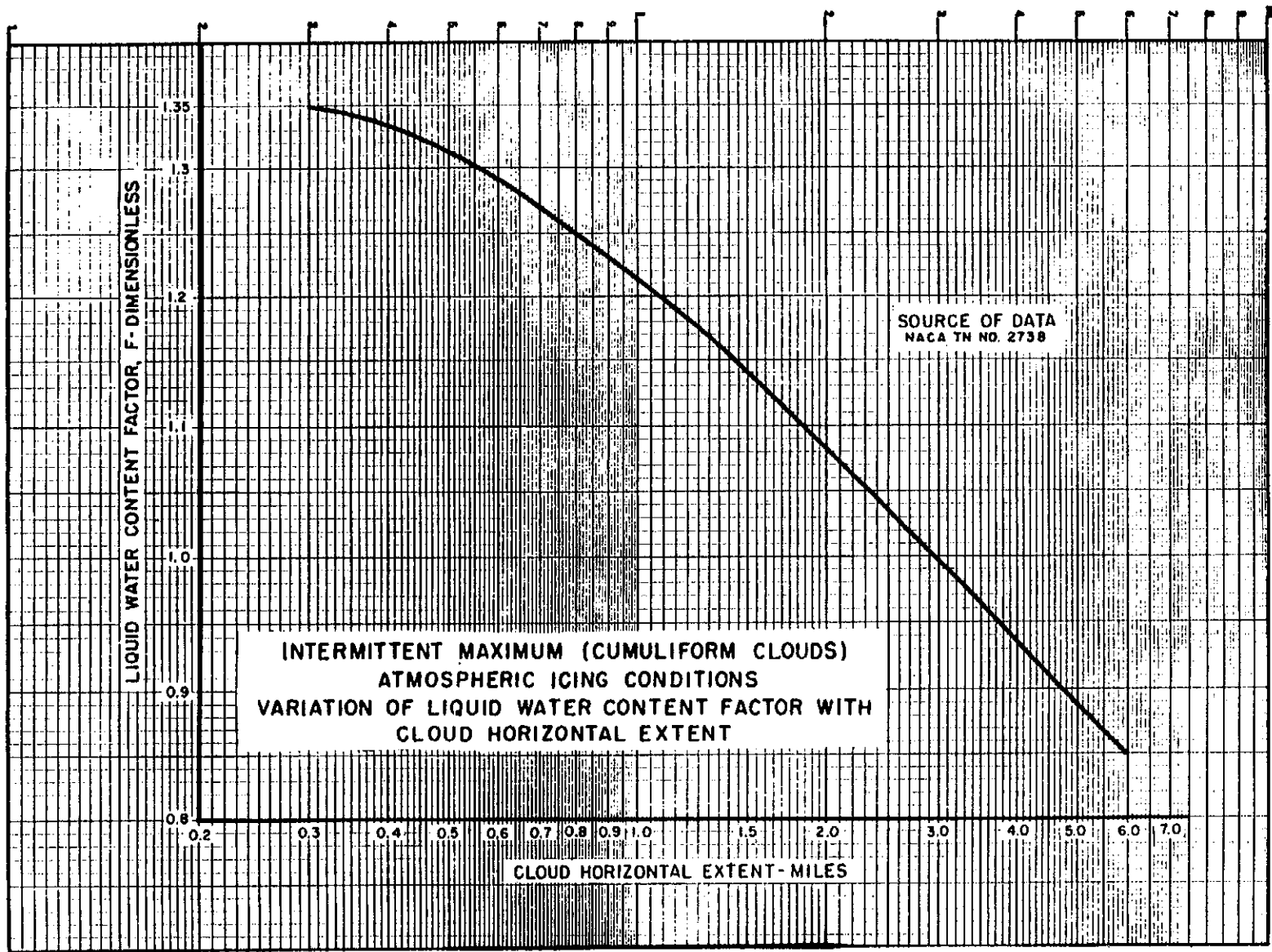

Figure 4b-25c.



Tow Point	Position	Load		
		Magnitude	No.	Direction
Main gear.		0.75 $F_{TOW}$ per main gear unit.	1	Forward, parallel to drag axis.
			2	Forward, at 30° to drag axis.
			3	Aft, parallel to drag axis.
			4	Aft, at 30° to drag axis.
Auxiliary gear.	Swiveled forward.	1.0 $F_{TOW}$ .	5	Forward.
			6	Aft.
	Swiveled aft.	0.5 $F_{TOW}$ .	7	Forward.
			8	Aft.
	Swiveled 45° from forward.	0.5 $F_{TOW}$ .	9	Forward, in plane of wheel.
			10	Aft, in plane of wheel.
	Swiveled 45° from aft.		11	Forward, in plane of wheel.
			12	Aft, in plane of wheel.

**BALANCING FORCES**

The side component of the towing load at the main gear is reacted by a side force at the static ground line at the wheel to which load is applied.

The towing loads at the auxiliary gear and the drag components of the towing loads at the main gear are reacted in each of the following ways:

- a. Reaction applied at the axle of the wheel to which load is applied, this reaction having a maximum value equal to the vertical reaction. Airplane inertia is applied as required for equilibrium.
- b. The loads reacted by airplane inertia.

Figure 4b-26.—Towing Loads.

Angle above or below horizontal plane	Effective intensity (candles)
0° to 5°	100
5° to 10°	60
10° to 20°	20
20° to 30°	10

Figure 4b-27.—Minimum effective intensities for anti-collision lights.

## Safety Equipment

**4b.640 Ice protection.** Compliance with this section is optional. The requirements of this section are intended to provide for safe flight in icing conditions. When compliance is shown with the provisions of this section, the type certificate shall include certification to that effect. When an airplane is certificated to include ice protection provisions, the recommended procedures for the use of the ice protection equipment shall be set forth in the Airplane Flight Manual (see sec. 4b.742 (a)). It shall be shown, as prescribed in paragraphs (a) and (b) of this section, that the airplane is capable of operating safely in continuous maximum and intermittent maximum icing conditions as defined in section 4b.1 (b) (7) and (8).

(a) An analysis shall be performed to establish, on the basis of the airplane's operational needs, the adequacy of the ice protection system for the various components of the airplane.

(b) In addition to the analysis and physical evaluation prescribed in paragraph (a) of this section, the effectiveness of the ice protection system and its components shall be shown by one or more of the following means:

(1) Laboratory dry air and/or simulated icing tests of the actual components or models thereof.

(2) Flight dry air tests of the ice protection system as a whole, or of its components individually.

(3) Flight tests of the airplane or its components in measured simulated icing conditions.

(4) Flight tests of the airplane in measured natural atmospheric icing conditions.

NOTE: For turbine-powered airplanes, the ice protection provisions of this section are considered to be primarily applicable to the airframe. For the powerplant installation, certain additional provisions of Subpart E of this Part may be found applicable.

**4b.641 Hand fire extinguishers.** (See secs. 4b.381, 4b.382, and 4b.383.)

**4b.642 Flare installation.**

(a) Parachute flares shall be releasable from the pilot compartment and installed to minimize the [probability] of accidental discharge.

(b) It shall be demonstrated in flight that the flare installation is such that ejection can be

accomplished without hazard to the airplane and its occupants.

(c) If recoil loads are involved in the ejection of the flares, the structure of the airplane shall withstand such loads.

(Amendment 4b-12, published 27 F. R. 2986, Mar. 30, 1962, effective May 3, 1962.)

**4b.642-1 Procedure for testing flare ejection (FAA policies which apply to sec. 4b.642(b)).** When flares are released, they should clear the aircraft structure when the airplane is flown at a speed of 1.4  $V_{S1}$  with the wing flaps and landing gear in both extended and retracted positions. If it is obvious that the flaps and gear have no effect upon the flare's path, the test may be conducted at one configuration. It is permissible to use dummy flares with parachutes for this test.

(19 F. R. 4466, July 20, 1954, effective Sept. 1, 1954.)

**4b.643 Safety belts.** Safety belts shall be of an approved type. In no case shall the rated strength of the safety belt be less than that corresponding with the ultimate load factors specified in section 4b.260 (a), taking due account of the dimensional characteristics of the safety belt installation for the specific seat or berth arrangement. Safety belts shall be attached so that no part of the anchorage will fail at a load lower than that corresponding with the ultimate load factors equal to those specified in section 4b.260 (a) multiplied by a factor of 1.33 [in lieu of the fitting factor prescribed in section 4b.307 (c).] In the case of safety belts for berths, the forward load factor need not be applied.

(Amendment 4b-12, published 27 F. R. 2986, Mar. 30, 1962, effective May 3, 1962.)

**4b.644 Safety belt signal.** When means are provided to indicate to the passengers when seat belts should be fastened, the device shall be so installed that it can be operated from the seat of either pilot or copilot.

**4b.645 Ditching equipment.** When the airplane is certificated for ditching in accordance with section 4b.361, and when required by the operating rules for the particular route to be flown, the ditching equipment shall be as prescribed in paragraphs (a) through [(e)] of this section.

(a) *Liferafts.* Liferafts shall be of an approved type. Unless excess rafts of sufficient capacity are provided, the buoyancy and seating capacity beyond the rated capacity of the rafts shall be such as to accommodate all occupants of the airplane in the event of a loss of one liferaft of the largest rated capacity on board. Each liferaft shall be equipped with a trailing line and with a static line, the latter designed to hold the raft near the airplane but to release it in case the airplane becomes totally submerged. Each raft shall contain obvious markings of instruction on the operation of the raft.

(b) *Liferaft equipment.* Approved equipment intended for survival shall be attached to each liferaft and marked for identification and method of operation.

NOTE: The extent and type of survival equipment will depend upon the route over which the airplane is operated.

(c) *Long-range signalling device.* An approved long-range signalling device shall be provided for use in one of the life rafts.

(d) *Life preservers.* Life preservers shall be of an approved type.

(e) *Life line.* Provisions shall be made for the storage of life lines, one attached to each side of the fuselage and arranged so that they can be used to enable occupants to stay on the wing after a ditching.

[(Amendment 4b-12, published 27 F. R. 2986, Mar. 30, 1962, effective May 3, 1962.)]

**4b.646 Stowage of safety equipment.** Special stowage provisions shall be made for all prescribed safety equipment to be used in emergencies. The stowage provision shall be such that the equipment is directly accessible and its location is obvious. All safety equipment shall be protected against inadvertent damage. The stowage provisions shall be marked conspicuously to identify the contents and to facilitate removal of the equipment. In addition, the following shall specifically apply:

(a) *Emergency exit means.* The stowage provisions for the emergency exit means required by section 4b.362 (e) (7) shall be located at the exits which they are intended to serve.

(b) *Liferafts.* The provisions for the stowage of liferafts required by section 4b.645 (a) shall accommodate a sufficient number of rafts for the maximum number of occupants for which the airplane is certificated for ditching. Stowage shall be near exits through which the rafts can be launched during an unplanned ditching. Rafts automatically or remotely released on the outside of the airplane shall be attached to the airplane by means of the static line prescribed in section 4b.645 (a).

(c) *Long-range signalling device.* The stowage provisions for the long-range signalling device required by section 4b.645 (c) shall be located near an exit to be available during an unplanned ditching.

(d) *Life preservers.* The provisions for the stowage of life preservers required by section 4b.645 (d) shall accommodate one life preserver for each occupant for which the airplane is certificated for ditching. They shall be located so that a life preserver is within easy reach of each occupant while seated.

**4b.647 Flotation means.** If the airplane is not equipped with life preservers in accordance with section 4b.645(d), an approved individual flotation means shall be provided for each occupant. Such flotation means shall be within easy reach of each occupant while seated and readily removable from the airplane.

## Miscellaneous Equipment

**4b.650 Radio and electronic equipment.**

(a) In showing compliance with section 4b.606 (a) and (b) with respect to radio and electronic equipment and their installations, consideration shall be given to critical environmental conditions.

NOTE: Critical environmental conditions may include temperature, pressure, humidity, ventilation, position, acceleration, vibration, and presence of detrimental substances.

(b) Radio and electronic equipment shall be supplied with power in accordance with the provisions of section 4b.623 (c).

(c) All radio and electronic equipment, controls, and wiring shall be so installed that operation of any one unit or system of units will not affect adversely the simultaneous operation of any other radio or electronic unit or system

of units required by the regulations in this subchapter.

**4b.651 Oxygen equipment and supply.** When required by the operating rules of the regulations in this subchapter, the supplemental and protective breathing equipment and its installation shall meet the following requirements:

(a) *General.* The oxygen system installed shall be free from hazards in itself, in its method of operation, and in its effect upon other components of the airplane. Means shall be provided to enable the crew to determine readily during flight the quantity of oxygen available in each source of supply. For airplanes certificated for operation at flight altitudes above 40,000 feet, oxygen flow rate and equipment shall be approved by the Administrator.

(b) *Required minimum mass flow of supplemental oxygen.* The minimum mass flow of supplemental oxygen required per person at various cabin pressure altitudes shall be that necessary to comply with the following requirements as applicable:

(1) Where continuous flow equipment is used by flight crewmembers, the minimum mass flow of supplemental oxygen required for each crewmember shall not be less than that which will maintain during inspiration a mean tracheal oxygen partial pressure of 149 mm. Hg. when breathing 15 liters per minute, BTPS, and having a maximum tidal volume of 700 cc. with a constant time interval between respirations.

(2) Where demand equipment is used by flight crewmembers, the minimum mass flow of supplemental oxygen required for each crewmember shall not be less than that which will maintain during inspiration a mean tracheal oxygen partial pressure of 122 mm. Hg. to and including a cabin pressure altitude of 35,000 feet and 95 percent oxygen between cabin pressure altitudes of 35,000 and 40,000 feet, when breathing 20 liters per minute BTPS. Provision shall be made to allow use of undiluted oxygen by crewmembers when they so desire.

(3) For passengers and cabin attendants the minimum mass flow of supplemental oxygen required for each person at various cabin pressure altitudes shall not be less than that which

will maintain during inspiration the following mean tracheal oxygen partial pressures when using the oxygen equipment provided, including masks:

(i) At cabin pressure altitudes above 10,000 feet to and including 18,500 feet, a mean tracheal oxygen partial pressure of 100 mm. Hg. when breathing 15 liters per minute, BTPS, and having a tidal volume of 700 cc. with a constant time interval between respirations.

(ii) At cabin pressure altitudes above 18,500 feet to and including 40,000 feet, a mean tracheal oxygen partial pressure of 83.8 mm. Hg. when breathing 30 liters per minute, BTPS, and having a tidal volume of 1,100 cc. with a constant time interval between respirations.

(4) Where first-aid oxygen equipment is required, the minimum mass flow of oxygen to each user shall not be less than 4 liters per minute, STPD, except that means may be provided to decrease this flow to not less than 2 liters per minute, STPD, at any cabin altitude. The quantity of oxygen required shall be based upon an average flow rate of 3 liters per minute per person for whom first-aid oxygen is required.

(5) Where portable oxygen equipment is required for crewmembers, the minimum mass flow of supplemental oxygen shall be as specified in subparagraph (1) or (2) of this paragraph, whichever is applicable.

(c) *Equipment standards for distribution system.* Where oxygen is to be supplied to both crew and passengers, the distribution system shall be designed to provide either:

(1) A source of supply for the flight crew on duty and a separate source for the passengers and other crewmembers, or

(2) A common source of supply with means provided so that the minimum supply required by the flight crew on duty can be separately reserved.

(d) *Equipment standards for dispensing units.* Where oxygen dispensing units are required, they shall comply with the provisions of subparagraphs (1) through (3) of this paragraph.

(1) An individual dispensing unit shall be provided for each occupant for whom supple-

mental oxygen is required to be furnished. All units shall be designed to cover the nose and mouth and shall be equipped with a suitable means for retaining the unit in position on the face for use. Flight crew masks for supplemental oxygen shall provide for the use of communication equipment. (For crew masks to be used for protective breathing purposes, see paragraph (h) of this section.)

(2) In airplanes certificated to operate at flight altitudes to and including 25,000 feet, there shall be available to and within reach of each flight crewmember an oxygen supply terminal and unit of oxygen dispensing equipment to provide for the immediate use of oxygen by such crewmember. For all other occupants the supply terminals and dispensing equipment shall be located so as to permit the use of oxygen as required by the operating rules of the regulations in this subchapter.

(3) In airplanes certificated to operate above 25,000 feet flight altitude, the provisions of subdivisions (i) through (iv) of this subparagraph shall apply:

(i) An oxygen dispensing unit connected to oxygen supply terminals shall be immediately available to each occupant wherever seated. In addition, in airplanes certificated to operate above 30,000 feet, the dispensing units providing the required oxygen flow rate shall be automatically presented to the occupants. To insure that sufficient dispensing units and outlets are available for all occupants, the total number shall exceed the number of seats by at least 10 percent with the extra units being as uniformly distributed throughout the cabin as practicable;

(ii) Crewmembers on flight deck duty shall be provided with demand equipment. An oxygen dispensing unit connected to an oxygen supply terminal shall be immediately available to each flight crewmember when seated at his station;

(iii) Not less than two outlets and units of dispensing equipment of a type similar to that required by subdivision (i) of this paragraph shall be located in each washroom; and in each lavatory if separate from the washroom; and

(iv) Portable oxygen equipment shall be immediately available for each cabin attendant.

(e) *Means for determining use of oxygen.* Means shall be provided to enable the crew to determine whether oxygen is being delivered to the dispensing units.

(f) *Fire protection.*

(1) Oxygen equipment and lines shall not be located in any designated fire zone.

(2) Oxygen equipment and lines shall be protected from heat which may be generated in or escape from any designated fire zone.

(3) Oxygen equipment and lines shall be so installed that escaping oxygen cannot cause ignition of accumulations of grease, fluids, or vapors which are likely to be present in normal operation or as a result of failure or malfunctioning of any system.

(g) *Protection from rupture.* Oxygen pressure tanks and lines between tanks and the shutoff means shall be protected from the effects of unsafe temperatures, and shall be so located in the airplane as to minimize the possibility and the hazards of rupture in a crash landing.

(h) *Protective breathing system.* When protective breathing equipment is required by the Civil Air Regulations, it shall be designed to protect the flight crew from the effects of smoke, carbon dioxide, and other harmful gases while on flight deck duty and while combating fires in cargo compartments (see sec. 4b.380(c)). The protective breathing equipment and the necessary supply of oxygen shall be in accordance with the following provisions:

(1) The protective breathing equipment shall include masks covering the eyes, nose, and mouth, or only the nose and mouth when accessory equipment is provided to protect the eyes. Such equipment while in use shall not prevent the flight crew from using the radio equipment of the airplane or from communicating with each other while at their assigned duty stations. That part of the equipment provided to protect the eyes shall be of a type and construction which will not cause any appreciable adverse effect on vision and shall permit wearing corrective glasses by individual members of the flight crew.

(2) A supply of protective oxygen per crew-member shall be of 15-minute duration at a pressure altitude of 8,000 feet and a respiratory minute volume of 30 liters per minute BTPD.

NOTE: When a demand type oxygen system is employed, a supply of 300 liters of free oxygen at 70° F. and 760 mm. Hg. pressure is considered to be of 15-minute duration at the prescribed altitude and minute volume. When a continuous flow protective breathing system is used, including a mask with a standard rebreather bag, a flow rate of 60 liters per minute at 8,000 feet (45 liters per minute at sea level) and a supply of 600 liters of free oxygen at 70° F. and 760 mm Hg. pressure is considered to be of 15-minute duration at prescribed altitude and minute volume. (BTPD refers to body temperature conditions, i. e., 37° C., at ambient pressure, dry.)

(19 F. R. 4466, July 20, 1954, effective Sept. 1, 1954.)

4b.651-1 *Safety precautions (FAA policies which apply to sec. 4b.651 (a)).* The oxygen system should be so located that leakage or failure in other systems carrying inflammable liquids or gases will not cause the inflammable liquid or gas to come in contact with oxygen lines or equipment. A relief valve or some other means is desirable in low pressure (400 p. s. i.) oxygen systems to safely relieve excessive pressures such as might be caused by overcharging. (See also sec. 4b.481 concerning location of tanks containing flammable fluids.)

(15 F. R. 8904, Dec. 15, 1950, effective Jan. 1, 1951.)

4b.651-2 *Protective breathing equipment (FAA policies which apply to sec. 4b.651 (h)).*

(a) *Conditions under which protective breathing equipment may be necessary.* These conditions are those outlined in section 4b.484-1, and sections 40.205-2, 41.24c-2, and 42.29-2 of this chapter.

(b) *Oxygen systems for flight deck duty.* The demand type oxygen system, or the diluter-demand type system with the lever of the diluter-demand regulator set at "100% OXYGEN" (Automix "OFF") are recommended for use as protective breathing equipment. However, a continuous flow protective breathing system may also be used. In any case the equipment should meet the requirements of section 4b.651 (h).

(c) *Portable equipment for flight deck duty.* Portable protective breathing units of the demand type may be used to meet the requirement of section 4b.651 in lieu of installing a

fixed protective breathing system. Portable continuous flow protective breathing units may also be used, but should not be used during fire fighting in Class A or B cargo compartments since any unused oxygen escaping from around the face mask might aggravate the existing fire.

(d) *Masks and goggles.*

(1) Protective breathing masks should fit snugly to prevent the entry of noxious gases. Continuous flow protective breathing masks should have no apertures through which outside air could be drawn into the system and should have a rebreathing bag of at least  $\frac{3}{8}$  liter capacity. The masks should be installed so as to be readily available to the appropriate crewmembers. It should be possible for at least the pilot or copilot to maintain ground to air radio voice communications when utilizing the protective breathing masks.

(2) Eye protecting goggles may be a part of or separate from the breathing mask. The goggles should provide an adequate field of vision and a means should be provided to overcome any unsatisfactory fogging tendency of the goggles. Periodic application of an effective antifogging agent on the lens is a satisfactory means of overcoming fogging.

(e) *Operating Instructions.* Operating instructions appropriate to the type of system and masks installed should be provided for the flight crew on placards and/or in the Airplane Flight Manual.

(15 F. R. 8904, Dec. 15, effective Jan. 1, 1951; amended 19 F. R. 4466, July 20, 1954, effective Sept. 1, 1954.)

4b.651-3 *Supplemental breathing equipment (FAA policies which apply to sec. 4b.651).*

(a) *Oxygen systems.*

(1) Either a continuous flow type system which uses a rebreather type mask or a diluter-demand type system with the lever of the diluter-demand regulator set in the "NORMAL" (Automix "ON") position will satisfactorily provide the supplemental oxygen required for protection against anoxia. The continuous flow system may be of the type which controls the oxygen flow by means of a hand adjustment type regulator, or an automatic type regulator.

(2) A diluter-demand type system with the lever of the diluter-demand regulator set in the

"100% OXYGEN" (Automix "OFF") position or a straight demand type system which uses a nondiluter-demand regulator may be used for supplementary breathing purposes as protection against anoxia. However, such use is not recommended due to the lack of oxygen economy of these systems when used to supply supplementary oxygen. As mentioned in section 4b.651-2, either of these closed demand systems is satisfactory for protection against toxic gases.

(b) *Operating instructions.* Operating instructions appropriate to the type of system and masks installed should be provided for the flight crew and other crewmembers concerned.

These instructions should include a graph or a table which will show the duration of the oxygen supply for the various bottled pressures and pressure altitudes.

(17 F. R. 11712, Dec. 24, 1952, effective Jan. 31, 1953.)

4b.651-4 *Design considerations for fixed systems (FAA policies which apply to sec. 4b.651).*

(a) *Location of outlets and equipment for crewmembers.* Protective breathing equipment should be immediately available for use. It is also desirable that supplementary breathing equipment be available for immediate use; however, the supplemental masks may be stowed in any location in the airplane provided operational procedures require that supplemental masks are at each crewmember location when needed. The oxygen outlet should be within reach; the oxygen mask should be stored in such a way that there will be a minimum delay in removing it and putting it into use. Provisions for keeping the masks sanitary and clean are desirable, but cumbersome wrapping or packaging of the mask which involve unnecessary effort and time to open should be avoided. The location of the oxygen outlet for a crewmember and the length of tubing connecting the mask of the crewmember and his oxygen outlet should be such that the visibility and the movement required of the crewmember in the performance of his duties are not impaired or restricted in any way. It should not be necessary for the crewmember to loosen or unfasten his seat belt in order for him to obtain his oxygen equipment and to put the system into use.

(b) *Location of outlets for passengers.* The operating regulations require that oxygen be furnished for certain percentages of the passengers at cabin pressure altitudes below 15,000 feet. The number of oxygen outlets need only be sufficient to administer oxygen to the percentage of passengers indicated by the operating rules; however, it is desirable in fixed systems to provide an outlet for each seat to enable a crewmember to readily administer oxygen to any passenger requiring it. If this is not accomplished, it is recommended that provision be made by means of portable equipment, extension tubing, or otherwise, to reduce the probability of having to move any passenger who may require the administration of oxygen. At cabin pressure altitudes above 15,000 feet the operating regulations require that oxygen be furnished to all of the passengers, in which case an outlet should be provided for each seat. (See also sec. 4b.651-5 concerning portable walk-around units.)

(c) *Line supports.* In a fixed installation, the oxygen lines should be supported to prevent excessive vibration and should be kept clear of the airplane structure or any other lines as a protection against chafing. Supports approximately every 24 inches along the length of the line should be adequate.

(d) *Shutoff valves.* System shutoff valves should be accessible in flight and should be installed as close as practicable to the cylinders in order to minimize the possibility of oxygen escape due to leakage or damage of lines between cylinders and valves.

(e) *Cylinder supports.* The supporting brackets for all cylinders should be capable of withstanding the inertia forces stipulated under the emergency landing conditions. (See sec. 4b.260.)

(17 F. R. 11713, Dec. 24, 1952, effective Jan. 31, 1953.)

4b.651-5 *Portable walk-around oxygen units (FAA policies which apply to sec. 4b.651).*

(a) Portable walk-around oxygen units of the continuous flow, diluter-demand and straight demand types may be used to satisfy part or all of the crew or passenger breathing requirements.

(b) Each portable oxygen unit should be considered as a complete oxygen system and any

regulations or pertinent interpretative material relative to oxygen systems should also be applicable to each portable unit.

(c) The supporting brackets for portable oxygen units should be capable of withstanding the inertia forces stipulated under the emergency landing conditions. (See sec. 4b.260.)

(17 F. R. 11713, Dec. 24, 1952, effective Jan. 31, 1953.)

4b.651-6 *Oxygen pressure gage (FAA policies which apply to sec. 4b.651 (a)).* At least one pressure gage, which can be observed by a flight crewmember during flight, should be installed to indicate the pressure in each source of oxygen supply.

(17 F. R. 11713, Dec. 24, 1952, effective Jan. 31, 1953.)

4b.651-7 *Supply required for continuous flow supplementary breathing systems (FAA policies which apply to sec. 4b.651 (b)).*

(a) *Formula for computing supply.*

(1) In computing the supply of oxygen required for a continuous flow system, the formula presented in the following paragraph may be used.

$$S = S_1 + S_2 + \dots + S_n$$

Where:

S=Total supply of oxygen required in cubic feet.  $S_1, S_2, \dots, S_n$ =the supply of  $O_2$  needed for each of the various cabin pressure altitudes which will be maintained during the flight.

(2) Each of the above supplies, namely,  $S_1, S_2, \dots, S_n$ , may be computed as follows:

$$S = N \times F \times T \times 2.12$$

S=supply of oxygen required in cubic feet (STPD). (To obtain supply in terms of cubic feet at 70° F. multiply cubic feet (STPD) by 1.08.)

N=number of oxygen users.

F=the actual flow in LPM (STPD) delivered to each oxygen mask at the cabin altitude under consideration. (See sec. 4b.651-7 (b).)

T=time in hours at the cabin altitude under consideration.

2.12=multiplying factor for converting the oxygen mass flow from liters per minute to cubic feet per hour.

NOTE: In computing the supply of oxygen for a given installation, those operating rules of the Civil Air Regulations which specify the amount of oxygen to be carried for operating at various altitudes should be considered.

(b) *Flow rates.*

(1) The intent of section 4b.651 (b) is to insure that for each oxygen user, a partial pressure of 149 mm Hg of oxygen is maintained in the inspired air at a breathing rate of 15 l. p. m. BTPD, at altitudes up to 25,000 feet. The rates of flow specified in Figure 4b-21 in Part 4b satisfy the intent of section 4b.651 (b) and constitute the values for "F" in the supply equation when there is no loss of bottle oxygen from the system (including the mask) when a 15 l. p. m. BTPD breathing rate is maintained.

(2) The oxygen mask, since it constitutes part of the system, will influence the value of "F". Continuous flow masks with rebreather bags which are currently standard types for aviation usage are satisfactory with the flow rates indicated by figure 4b-21. Where a receptacle or mask design differs from these, the manufacturer should be requested to supply information concerning the flow rate necessary to maintain the 149 mm Hg partial pressure at a 15 l. p. m. BTPD breathing rate. If the actual mass flow is greater than the minimum required, then the higher flow rate should be used as the value for "F".

(3) It is possible that certain automatic continuous flow regulators will furnish oxygen flows in excess of the minimum required; in this case, the actual flow rates should be used as the values for "F".

NOTE.—(1) BTPD signifies gas at 37° C. (body temperature), ambient pressure, dry.

(2) STPD signifies gas at 0° C., 760 mm Hg, dry.

(17 F. R. 11713, Dec. 24, 1952, effective Jan. 31, 1953, revised 19 F. R. 4467, July 20, 1954, effective Sept. 1, 1954.)

4b.651-8 *Supply required for diluter-demand system (FAA policies which apply to sec. 4b.651).*

(a) Tests conducted by the Armed Forces on currently available diluter-demand regulators indicate that some types deliver more oxygen than is required by figure 4b-21. Conse-



quently, in computing the supply required for a diluter-demand system, the flow characteristics at various altitudes should be obtained from the manufacturer of the regulator. Where this information is not available, the values listed in the following table may be used for Air Force-Navy approved diluter-demand regulators:

Altitude in feet	Flow per person in LPM (STPD) <sup>1</sup>
8,000.....	1. 90
10,000.....	1. 90
15,000.....	2. 10
20,000.....	2. 50
25,000.....	4. 10

<sup>1</sup> These values are based on tests on a large group of men using the equipment at the altitude specified. The values listed are those calculated to completely protect 95 percent of the population.

(b) The formula outlined in section 4b.651-7 (a) may be used in computing the supply of oxygen for supplementary breathing purposes.

(17 F. R. 11713, Dec. 24, 1952, effective Jan. 31, 1953; amended 19 F. R. 4467, July 20, 1954, effective Sept. 1, 1954.)

4b.651-9 *Requirements for approval of oxygen systems (FAA policies which apply to sec. 4b.651 (b)).* Prior to the approval of an oxygen system, the system should be examined to determine that the flow of oxygen through each outlet is at least equal to the minimum required by section 4b.651 (b) at all altitudes for which the aircraft is certificated. This can be accomplished by one of the following methods or by any other satisfactory procedure:

(a) *Pressure measurement.*

(1) In a continuous flow system when the calibration (inlet pressure vs. flow) of the orifices used at the plug-in outlets is known, the pressure in the low pressure distribution line can be measured at the point which is subject to the greatest pressure drop. This should be done with oxygen flowing from all outlets. The pressure thus measured should indicate a flow equal to or greater than the minimum flow required.

(2) In lieu of the above procedure, the flow of oxygen through the outlet which is subject to the greatest pressure drop may be

measured. This should be accomplished with all other outlets open. Gas meters, rotometers, or other suitable means may be used to measure flows.

(3) The measurement of oxygen flows in a continuous flow system which uses a manually adjusted regulator can be accomplished at sea level. However, in a continuous flow system which uses an automatic type regulator, it may be necessary to check the flows at the maximum altitude which will be encountered during the normal operation of the aircraft. The manufacturer of the particular continuous flow regulator being used should be able to furnish data on the operating characteristics of the regulator from which it can be determined whether flight tests are necessary.

(b) *Availability of oxygen.*

(1) The checking of the amount of oxygen flow through the various outlets in a diluter-demand or straight demand system is not necessary since the flow characteristics of the particular regulator being used may be obtained from the manufacturer of the regulator. However, in such systems the availability of oxygen to each regulator should be checked as follows:

(i) Turn the lever of the diluter-demand regulator to the "100% OXYGEN" position and inhale through the tube via the mask to determine whether the regulator valve and the flow indicator are operating. Deficient units should be replaced.

(17 F. R. 11713, Dec. 24, 1952, effective Jan. 31, 1953.)

4b.651-10 *Means for determining oxygen flow to crewmembers (FAA policies which apply to sec. 4b.651 (e)).*

(a) *Supplementary breathing systems.*

(1) Where continuous flow or diluter-demand systems are used for supplementary breathing purposes, each crewmember should have an individual flow indicator for determining oxygen flow or the operator may establish a suitable procedure for determining oxygen flow and should include such procedures in the Airplane Flight Manual.

(2) If flow indicators are used, the indicator for any particular crewmember should be located so as to be easily observed by him

while he is at his crew station. Acceptable flow indicators are listed in section 4b.651-12.

(3) If a suitable procedure is to be used for determining oxygen flow in nonpressurized cabin aircraft, the procedure should include initial and periodic checking of the oxygen flow by each crewmember by any acceptable method. Some of the acceptable methods are described under section 4b.651-11 (a) and (b). In pressurized cabin aircraft when supplementary oxygen is required immediately following cabin pressurization failure, positive means for determining flow under emergency conditions should be established which would not involve delay or activities which would interfere with a flight crewmember's performance of his primary duties. Since utilizing one of the methods for determining oxygen flow permitted for supplementary breathing equipment described under section 4b.651-11 (a) and (b) involves some time delay, a flight crewmember could don his protective breathing equipment following a pressurization failure because with such equipment oxygen flow is immediately apparent. As soon as some degree of control of the emergency has been established and sufficient time is available to determine oxygen flow by one of the methods mentioned above, he could change over to his supplementary breathing equipment.

(b) *Protective breathing systems.* No flow indicators are required in protective breathing systems since with these systems the lack of oxygen flow would be immediately evidenced by the oxygen user's inability to inhale while wearing mask.

(17 F. R. 11714, Dec. 24, 1952, effective Jan. 31, 1953; amended 19 F. R. 4467, July 20, 1954, effective Sept. 1, 1954.)

4b.651-11 *Means for determining oxygen flow to passengers (FAA policies which apply to sec. 4b.651 (e)).* Each passenger may be supplied with an individual flow indicator of a type specified in section 4b.651-12 or the operator involved may establish a suitable procedure for checking the oxygen flow to each oxygen user. Procedures which utilize the following means for checking oxygen flow to each user will be satisfactory.

(a) In the case where a continuous flow system is used, the means may be the observing of the rebreather bag on each continuous flow mask by a trained crewmember. If oxygen flow is occurring the rebreather bag will continue to expand when the oxygen user periodically refrains from exhaling when the bag is empty or partially empty, or in cases where high oxygen flows are occurring, the rebreather bag may not empty completely during normal inhalation. Any alternate method of checking oxygen flow may be used providing positive indication of flow is given. For example, prior to giving a mask to a passenger, the crewmember may find it expedient to feel the flow of oxygen at the oxygen outlet in the mask or to constrict the tubing and listen to audible sounds characteristic of gas flow. If a listening test is employed to determine the flow of oxygen, it should be demonstrated in flight that the test is satisfactory.

(b) In the case where a diluter-demand system is used, the procedure may be checking of the oxygen flow by a trained crewmember by momentarily moving the regulator lever to Automix "OFF" (100 PERCENT OXYGEN) while the mask is being worn. Lack of oxygen flow will be immediately evidenced by the user's inability to inhale while wearing his mask.

(c) The oxygen flow to each passenger should be checked when the passenger is first given oxygen and at subsequent intervals if the circumstances prevailing at the time indicate such a check is desirable.

(d) Any crewmember assigned by an air carrier for the performance of duty on the aircraft during flight may check the oxygen flow to the passengers if trained to do so.

(17 F. R. 11714, Dec. 24, 1952, effective Jan. 31, 1953.)

4b.651-12 *Types of flow indicators (FAA policies which apply to sec. 4b.651 (e)).* A pith ball flow indicator, vane, or wheel anemometer, lateral pressure indicator which fluctuates with changes in flow or any other satisfactory flow indicator may be used in a continuous flow type system. An Air Force-Navy flow indicator or equivalent may be used in a diluter-demand type system. Each flow indicator should give

positive indication when oxygen flow is occurring.

(17 F. R. 11714, Dec. 24, 1952, effective Jan. 31, 1953.)

#### 4b.653 *Hydraulic systems; strength.*

(a) *Structural loads.* All elements of the hydraulic system shall be designed to withstand, without detrimental permanent deformation, all structural loads which may be imposed simultaneously with the maximum hydraulic loads occurring in operation.

(b) *Proof pressure tests.* All elements of the hydraulic system shall be tested to a proof pressure of 1.5 times the maximum pressure to which the part will be subjected in normal operation. In such test no part of the hydraulic system shall fail, malfunction, or suffer detrimental deformation.

(c) *Burst pressure strength.* Individual hydraulic system elements shall be designed to withstand pressures which are sufficiently increased over the pressures prescribed in paragraph (b) of this section to safeguard against rupture under service conditions.

NOTE: The following pressures, in terms of percentage of maximum operating pressure for the particular element, in most instances are sufficient to insure against rupture in service: 250 percent in units under oil pressure, 400 percent in units containing air and oil under pressure and in lines, hoses, and fittings, 300 percent in units of system subjected to back pressure.

#### 4b.654 *Hydraulic systems; design.*

(a) *Pressure indication.* A means shall be provided to indicate the pressure in each main hydraulic power system.

(b) *Pressure limiting provisions.* Provision shall be made to assure that pressures in any part of the system will not exceed a safe limit above the maximum operating pressure of the system and to insure against excessive pressures resulting from fluid volumetric

changes in all lines which are likely to remain closed long enough for such changes to take place. In addition, consideration shall be given to the possible occurrence of detrimental transient (surge) pressures during operation.

(c) *Installation.* Hydraulic lines, fittings, and components shall be installed and supported to prevent excessive vibration and to withstand inertia loads. All elements of the installation shall be protected from abrasion, corrosion, and mechanical damage.

(d) *Connections.* Flexible hose, or other means of providing flexibility, shall be used to connect points in a hydraulic fluid line between which there is relative motion or differential vibration.

4b.655 *Hydraulic system fire protection.* When flammable type hydraulic fluid is used, the hydraulic system shall comply with the provisions of sections 4b.385, 4b.481, 4b.482, and 4b.483.

#### 4b.658 *Vacuum systems.*

(a) Means, in addition to the normal pressure relief, shall be provided to relieve automatically the pressure in the discharge lines from the vacuum pump, if the delivery temperature of the air reaches an unsafe value.

(b) Vacuum system lines and fittings on the discharge side of the pump which might contain flammable vapors or fluids shall comply with section 4b.483 if they are located in a designated fire zone. Other vacuum system components located in designated fire zones shall be fire-resistant.

4b.660 *Draining of fluids subject to freezing.* When liquids subject to freezing are drained overboard either in flight or during ground operation, drains shall be located and designed to prevent the formation of ice on the airplane as a result of such drainage.

## Subpart G—Operating Limitations and Information

### General

#### 4b.700 *Scope.*

(a) The operating limitations listed in sections 4b.710 through 4b.723 shall be established as prescribed in this part.

(b) The operating limitations, together with any other information concerning the airplane

found necessary for safety during operation, shall be included in the Airplane Flight Manual (sec. 4b.740), shall be expressed as markings and placards (sec. 4b.730), and shall be made available by such other means as will convey the information to the crewmembers.

4b.700-1 *Automatic propeller feathering op-*

erating limitations and information (FAA policies which apply to sec. 4b.700).

(a) All limitations on the use of automatic feathering system, including flight conditions when the system must be operative or inoperative, should be determined and noted when appropriate.

(b) Any placards found necessary should be provided in the airplane.

(c) A complete statement of operating limitations and instructions for the use of the system should be included in the Airplane Flight Manual.

(d) If certification is desired both with and without the feathering system operative, two corresponding sets of performance data properly identified should be included in the Airplane Flight Manual. (See also sec. 4b.10-2.)

(19 F. R. 1818, Apr. 2, 1954, effective Apr. 2, 1954.)

## Operating Limitations

### 4b.710 *Airspeed limitations; general.*

When airspeed limitations are a function of weight, weight distribution, altitude, or Mach number, the values corresponding with all critical combinations of these values shall be established.

**[4b.711 *Maximum operating limit speed*  $V_{MO}/M_{MO}$ .** The maximum operating limit speed is a speed, which shall not be deliberately exceeded in any regime of flight (climb, cruise, or descent), except where a higher speed is authorized for flight test or pilot training operations. This operating limitation, denoted by the symbols  $V_{MO}/M_{MO}$  (airspeed or Mach number, whichever is critical at a particular altitude), shall be established to be not greater than the design cruising speed  $V_C$  and sufficiently below  $V_D/M_D$  or  $V_{DF}/M_{DF}$  to make it highly improbable that the latter speeds will be inadvertently exceeded in operations. The speed margin between  $V_{MO}/M_{MO}$  and  $V_D/M_D$  or  $V_{DF}/M_{DF}$  shall be determined in accordance with either paragraph (a) or (b) of this section, but shall not be less than the margin found necessary in flight tests in accordance with section 4b.191. (Also see sec. 4b.603(k) concerning speed warnings means.)

**[(a)** The minimum margin shall be the greater of the values determined in accordance

with subparagraphs (1) and (2) of this paragraph.

**[(1)** From an initial condition of stabilized flight at  $V_{MO}/M_{MO}$ , the airplane shall be assumed to be upset, flown for 20 seconds along a flight path 7.5 degrees below the initial path and pulled up at a load factor of 1.5 (.5g acceleration increment). It shall be acceptable to calculate the speed increase occurring in this maneuver, provided reliable or conservative aerodynamic data are used. Power, as specified in section 4b.155(a), shall be assumed until the pullup is initiated, at which time power reduction and the use of pilot controlled drag devices may be assumed.

**[(2)** The margin shall be sufficient to provide for atmospheric variations, such as horizontal gusts, penetration of jet stream or cold front, and for instrument errors and airframe production variations. It shall be acceptable to consider these factors on a probability basis, but the margin at altitudes where  $M_{MO}$  is limited by compressibility effects shall not be less than 0.05M.

**[(b)**  $V_{MO}/M_{MO}$  shall not be greater than 0.8  $V_D/M_D$  or 0.8  $V_{DF}/M_{DF}$ .]

**[(Amendment 4b-12, published 27 F. R. 2986, Mar. 30, 1962, effective May 3, 1962.)]**

**4b.713 *Maneuvering speed.*** The maneuvering speed shall not exceed the design maneuvering speed  $V_A$  determined in accordance with section 4b.210 (b) (2).

**[4b.714 *Flap extended speeds,  $V_{FE}$ .*** Flap extended speeds,  $V_{FE}$ , shall be established not to exceed the design flap speeds,  $V_F$ , chosen in accordance with sections 4b.210(b)(1) and 4b.212 for the corresponding flap positions and engine powers.]

**[(Amendment 4b-12, published 27 F. R. 2986, Mar. 30, 1962, effective May 3, 1962.)]**

**4b.715 *Landing gear operating speed*  $V_{LO}$ .** The landing gear operating speed  $V_{LO}$  shall be established not to exceed a speed at which it is safe to extend or retract the landing gear as limited by design in accordance with section 4b.334 or by flight characteristics.

**4b.716 *Landing gear extended speed*  $V_{LE}$ .** The landing gear extended speed  $V_{LE}$  shall be established not to exceed a speed at which it has been shown that the airplane can

be safely flown with the landing gear secured in the fully extended position, and for which the structure has been proven in accordance with section 4b.334.

**4b.717 Minimum control speed  $V_{MC}$ .** (See sec. 4b.133.)

**4b.718 Powerplant limitations.** The following powerplant limitations shall be established for the airplane as applicable for the type(s) of engine(s) installed. They shall not exceed the corresponding limits established as part of the type certification of the engine and propeller installed in the airplane.

**(a) Takeoff operation.**

- (1) Maximum rotational speed (r. p. m.);
- (2) Maximum permissible manifold pressure;
- (3) Maximum permissible gas temperature for turbine engines;
- (4) The time limit for use of the power which corresponds with the values established in subparagraphs (1) through (3) of this paragraph;
- (5) When the time limit established in subparagraph (4) of this paragraph exceeds 2 minutes, the maximum allowable cylinder head and oil temperatures; and
- (6) Maximum cylinder head and oil temperatures if these differ from the maximum limits for continuous operation.

**(b) Maximum continuous operation.**

- (1) Maximum rotational speed (r. p. m.);
- (2) Maximum permissible manifold pressure; and
- (3) Maximum permissible cylinder head, oil, and gas temperatures.

**[(c) Fuel grade or specification designation.** The minimum fuel grade for reciprocating engines or the fuel designation for turbine engines, required for the operation of the engine within the limitations prescribed in paragraphs (a) and (b) of this section.

**[(d) Maximum ambient atmospheric temperature.** The maximum ambient atmospheric temperature at which compliance with the cooling provisions of sections 4b.450 through 4b.452 is established.]

[(Amendment 4b-12, published 27 F. R. 2986, Mar. 30, 1962, effective May 3, 1962.)]

4b.718-1 *Powerplant limitations governing minimum quantity of antidetonant fluid re-*

*quired for takeoff (FAA policies which apply to sec. 4b.718).* The Airplane Flight Manual should include a limitation indicating that the minimum quantity of anti detonant fluid required is that determined from section 4b.420-1 (a) and (b). If the performance characteristics of the airplane are such that wet power is required for takeoff but may or may not be required for landing, depending upon airport location or characteristics, the Airplane Flight Manual may include information covering minimum allowable quantities under both conditions.

(20 F. R. 2281, Apr. 8, 1955, effective Apr. 30, 1955.)

**4b.719 Airplane weight, center of gravity, and weight distribution limitations.** The airplane weight, center of gravity, and weight distribution limitations shall be those prescribed in sections 4b.101, 4b.102, and 4b.103. Where the airplane is certificated for more than one center of gravity range, the appropriate limitations with regard to weight and loading procedures shall be set forth in the Airplane Flight Manual for each separate center of gravity range.

**4b.720 Minimum flight crew.** The minimum flight crew shall be established by the Administrator as that number of persons which he finds necessary for safety in the operations authorized under section 4b.721. This finding shall be based upon the work load imposed upon individual crewmembers with due consideration given to the accessibility and the ease of operation of all necessary controls by the appropriate crewmembers.

**4b.721 Types of operation.** The types of operation to which the airplane is limited shall be established by the category in which it has been found eligible for certification and by the equipment installed. (See the operating rules in this subchapter.)

**4b.722 Maximum operating altitude.** A maximum altitude shall be established up to which operation is permitted, as limited by flight, structural, powerplant, functional, or equipment characteristics.

**4b.723 Maneuvering flight load factors.** Load factor limitations shall be established not to exceed the positive limit load factors determined from the maneuvering diagram, figure 4b-2. (See sec. 4b.211 (a).)

## Markings and Placards

### 4b.730 *General.*

(a) Markings and placards shall be displayed in conspicuous places and shall be such that they cannot be easily erased, disfigured, or obscured.

(b) Additional information, placards, and instrument markings having a direct and important bearing on safe operation of the airplane shall be required when unusual design, operating, or handling characteristics so warrant.

4b.730-1 *Reverse thrust placards (FAA policies which apply to sec. 4b.730).* The policies outlined in section 4b.402-1 (b) will apply.

(20 F. R. 2281, Apr. 8, 1955, effective Apr. 30, 1955.)

### 4b.731 *Instrument markings; general.*

(a) When markings are placed on the cover glass of the instrument, provision shall be made to maintain the correct alignment of the glass cover with the face of the dial.

(b) All arcs and lines shall be of sufficient width and so located that they are clearly visible to the pilot.

4b.732 *Airspeed limitation information.* The airspeed limitations (see sec. 4b.741 (a)) shall be presented in such a manner that they can be easily read and interpreted by the flight crew.

4b.733 *Magnetic direction indicator.* A placard shall be installed on or in close proximity to the magnetic direction indicator which shall comply with the following:

(a) The placard shall contain the calibration of the instrument in a level flight attitude with engine(s) operating.

(b) The placard shall state whether the calibration was made with radio receiver(s) on or off.

(c) The calibration readings shall be in terms of magnetic headings in not greater than 45° increments.

4b.734 *Powerplant instruments; general.* All required powerplant instruments shall be marked as follows:

(a) The maximum and the minimum (if applicable) safe operational limits shall be marked with red radial lines.

(b) The normal operating ranges shall be marked with a green arc not extending beyond

the maximum and minimum safe operational limits.

(c) The takeoff and precautionary ranges shall be marked with a yellow arc.

(d) Engine or propeller speed ranges which are restricted because of excessive vibration stresses shall be marked with red arcs.

4b.735 *Oil quantity indicators.* Oil quantity indicators shall be marked in sufficient increments to indicate readily and accurately the quantity of oil.

4b.736 *Fuel quantity indicator.* When the unusable fuel supply for any tank exceeds 1 gallon or 5 percent of the tank capacity, whichever is the greater, a red arc shall be marked on the indicator extending from the calibrated zero reading to the lowest reading obtainable in the level flight attitude. A notation in the Airplane Flight Manual shall be made to indicate that the fuel remaining in the tank when the quantity indicator reaches zero is not usable in flight. (See sec. 4b.613 (b).)

4b.737 *Control markings; general.* All cockpit controls, with the exception of the primary flight controls and other controls the function of which is obvious, shall be plainly marked and/or identified as to their function and method of operation. The markings shall include the following:

(a) *Aerodynamic controls.* The secondary aerodynamic controls shall be marked to comply with sections 4b.322 and 4b.323.

(b) *Powerplant fuel controls.*

(1) Controls for fuel tank selector valves shall be marked to indicate the position corresponding with each tank and with all possible cross-feed positions.

(2) When more than one fuel tank is provided, and if safe operation depends upon the use of tanks in a specific sequence, the fuel tank selector controls shall be marked adjacent to or on the control itself to indicate the order in which the tanks should be used.

(3) Controls for engine selector valves shall be marked to indicate the position corresponding with each engine.

(c) *Accessory and auxiliary controls.*

(1) When a retractable landing gear is used, the visual indicator required in section 4b.334 (e) shall be marked so that the pilot

can ascertain at all times when the wheels are locked in either extreme position.

(2) Emergency controls, including fuel jettisoning and fluid shutoff controls, shall be colored red and shall be marked to indicate their function and method of operation.

**4b.738 Miscellaneous markings and placards.**

(a) *Baggage compartments and ballast location.* Each baggage and cargo compartment as well as the ballast location shall bear a placard stating the maximum allowable weight of contents and, if applicable, any other limitation on contents found necessary due to loading requirements.

(b) *Fuel and oil filler openings.* The following information shall be marked on or adjacent to the appropriate filler cover:

(1) The word "fuel", the minimum permissible fuel [grade or designation] for the engines installed, and the usable fuel tank capacity (see sec. 4b.416),

(2) The word "oil" and the oil tank capacity.

(c) *Emergency exit placards.* (See sec. 4b.362 (f).)

(d) *Safety equipment.*

(1) Safety equipment controls which the crew is expected to operate in time of emergency, such as flares, automatic life raft releases, etc., shall be readily accessible and plainly marked as to their method of operation.

(2) When fire extinguishers and signaling and other lifesaving equipment are carried in lockers, compartments, etc., these locations shall be marked accordingly.

(e) *Airspeed placard.* A placard shall be installed in clear view of each pilot giving the maximum airspeeds for flap extension to the takeoff, approach, and landing positions.

[(Amendment 4b-12, published 27 F. R. 2986, Mar. 30, 1962, effective May 3, 1962.)]

## Airplane Flight Manual

### 4b.740 General.

(a) An Airplane Flight Manual shall be prepared by the applicant for the type certificate and shall be furnished with each airplane except with those airplanes which specifically are not

required by the operating parts of the Civil Air Regulations to carry such manual.

(b) The portions of the manual listed in sections 4b.741 through 4b.743 as are appropriate to the airplane shall be verified and approved and shall be segregated, identified, and clearly distinguished from portions not so approved.

(c) Additional items of information having a direct and important bearing on safe operation shall be required when unusual design, operating, or handling characteristics so warrant.

**4b.740-1 Preparation of Airplane Flight Manuals for aircraft certificated in the transport category (FAA policies which apply to sec. 4b.740).** The primary purpose of the manual is to provide for the crew who will operate the airplane any information concerning the airplane considered by the Federal Aviation Agency essential to or likely to promote safety during such operation. This will ordinarily require a certain amount of descriptive material concerning those parts of the airplane directly operated or otherwise used by the crew, and understanding by them of the nature, location, and functioning of which is therefore essential. The manual should also contain, in order to serve this purpose, a description and chronological outline of the procedure to be followed by the crew during various phases of the operation both "normal" and "emergency" in which special attention and emphasis should be given to any precaution which should be observed therein in the interest of safety.

Another important purpose of the manual is to implement the operating requirements of Parts 40, 41, and 42 of this subchapter; i. e., to furnish a source for all the airplane information necessary to establish the limitations specified by those requirements as well as that necessary to enable the crew readily to operate the airplane within the limitations so established. This purpose requires the inclusion in the manual of all operating limitations peculiar to the airplane under any circumstances likely to be encountered during its life as well as information concerning each of the items of performance involved by Parts 40, 41 and 42 of this subchapter as functions of weight, altitude, outside air temperature, wind velocity, flap setting, etc., throughout the range of these variables for which it is desired by the applicant to

provide; the point being that the scheduled operation of the airplane by an air carrier will be limited to values of all such variables within the range(s) covered by information available in the manual. This situation requires that the applicant consider the extent to which he wishes to limit the usefulness of the airplane subsequent to its certification as a type.

It may be noted, concerning the material to be included in the manual, that two types are involved. The first of these is the operating limitations which are, in effect, a partial statement of the terms upon which the airworthiness certificate is issued. Compliance with these operating limitations is therefore required by law (see sec. 610 (a) of the Federal Aviation Act of 1958 and sec. 4b.738 (d)). The second type of material is the performance information, recommended operating procedures, and loading instructions, the observance or use of which is not legally required of the operator of the airplane by Part 4b but may be required by Parts 40, 41, and 42 of this subchapter. This second type of material is intended to convey information believed likely to promote or contribute to safety in operation.

The following outlines an acceptable arrangement of the Airplane Flight Manual. This policy does not affect the status of manuals which already have final approval. However, whenever such manuals are revised for other reasons, it is recommended that the terminology of this policy be incorporated wherever it will increase clarity and uniformity. It should be noted that not *all* the items outlined below for inclusion in the document for a given airplane, and the Federal Aviation Agency is desirous of holding the document to the smallest practicable amount of material as it is believed that the usefulness of the manual will bear some inverse relation to its physical bulk and to the extent of its complexity. It is, therefore, strongly recommended that great care be taken to prepare it in the simplest, most compact form consistent with the completeness and clarity of presentation of the necessary information. Also it is suggested that consideration be given to the likelihood of revisions and the manner in and ease with which this may be accomplished. Only the material (listed below) required by Part 4b should be included in the

Federal Aviation Agency approved portion of the manual. However, if desired, the manufacturer or operator may add other data in a distinctly separate section in the same cover. The portion of the material (outlined below) that is to be approved by the Federal Aviation Agency must be so marked, and clearly separated from any other material so that no one could easily err in regard to the part that is approved. The aircraft specification for the type will list the manual as an item of required equipment and the manual must be made available upon request to any FAA inspector issuing an original airworthiness certificate under the type certificate in order that he may verify that the manual furnished with that individual airplane conforms with the approved manual. Since the manual is necessary for safe operation of the airplane, the manual is considered to be public information.

There is no objection to air carrier operators incorporating the subject manual in their own Operations Manual which is assigned to individual crewmembers in lieu of carrying two separate manuals provided the manual which is furnished by the air carrier includes a separate and properly identified chapter which contains the manufacturer's issue of the FAA Approved Airplane Flight Manual or a satisfactory reproduction identical in both form and contents. The Airplane Flight Manual or its equivalent may, in lieu of individual identification by serial or N numbers, contain a list of the airplanes to which the manual is applicable. Such manuals may be installed in the aircraft or be issued to members of the flight crew. Regardless of the procedure in effect, it is the air carrier operator's responsibility to establish a satisfactory system whereby an up-to-date copy of the appropriate manual for the particular airplane is readily available to the flight crew during the operation of the airplane. Inasmuch as the subject manual constitutes a required item of equipment, it is the responsibility of the assigned Air Carrier Maintenance Inspector to ascertain that an appropriate and up-to-date copy, or its equivalent, is available to the crew at all times during flight.

The page size for the Airplane Flight Manual will be left to the decision of the manufacturer, although it is believed that an 8" x 10½" size



will probably be found most convenient and this size is recommended. A cover should be provided and it should indicate the nature of the contents with the following title: "Airplane Flight Manual." Each page of the approved portion should bear the notation "FAA Approved" and the date of issuance. The material should be bound in a semi-permanent fashion so that the pages will not be lost easily, yet should be so bound that revised pages can be inserted. The aircraft specification will identify the manual, and when different types of the airplane are covered in separate manuals, each will be listed. Also, the latest approved revisions will be shown on the aircraft specification when these changes are considered to be of major importance to airworthiness.

The Airplane Flight Manual should contain as much of the following as is applicable to the individual model. It is suggested that the document be divided into sections as indicated in paragraphs (a) through (g) of this section. The sequence of sections and of items within sections should follow this outline insofar as practicable. This will facilitate revising the document when an airplane is altered in the field. It is recommended that revisions to the manual resulting from major alterations to the airplane be in the form of supplements to the original manual with individual log of revision pages.

(a) *Introduction.*

(1) *Title page.* This page should include the manufacturer's name, airplane model, registration or serial number, date of approval and space for the signature of the Chief, Engineering and Manufacturing Branch. In addition the following note should be included: "This airplane must be operated in compliance with the Operating Limitations herein."

(2) *Table of contents.*

(3) *Log of revisions.* This page should be in the form of a table in which to record for each revision an identifying symbol, a date, and the page numbers involved. All revised pages should show a revision date and a vertical bar should be placed along the left-hand margin to indicate the latest revised portion of each page.

(b) *Operating limitations.* The purpose of this section is merely to state the limitations without any unnecessary explanation of what

they are. The manual should point out that observance of these limitations is required by law.

(1) *Weight limits.* Indicate the range of maximum takeoff and landing weight approved by means of a table or suitable diagram showing these weights at various altitudes throughout the range for which performance information is contained in the manual. State that airplane weight in excess of maximum landing weight must be disposable fuel. State any other limitations on weight. In addition to the maximum weights and any relative information, a statement to the effect that the airplane must be loaded in accordance with the approved loading schedule should be included. (See paragraph (e) of this section.) The following is a typical example:

(i) Maximum takeoff weight at sea level is 92,000 pounds.

(ii) Maximum landing weight at sea level is 73,000 pounds.

Note: This airplane is to be operated in accordance with the approved loading schedule. (See paragraph (e) of this section.) For maximum permissible weights at various altitudes, see paragraph (d), Performance Information, of this section. In scheduled or irregular passenger operations, operating weights are limited in accordance with Parts 40, 41, or 42 of this subchapter.

(iii) All weight in excess of the maximum permissible landing weight must consist of disposable fuel.

(iv) All weight in excess of 68,000 pounds must consist of fuel for structural reasons.

(v) All fuel weight must be distributed equally on both sides of the airplane. All main tanks must be filled (equally) first, alternate second, and then auxiliaries. Fuel must be used in reverse order from fuel loading except for takeoff, climb and landing—at which time the main tanks should be used.

(2) *Center of gravity limits.* State all authorized c. g. limits and refer to (e) of this section for weight and balance data. All c. g. limits should be given in inches from the datum, which should be identified and in percent of the mean aerodynamic chord, with the landing gear extended in all cases.

(3) *Powerplant.* State all powerplant limitations; i. e., manifold pressure, r. p. m.,

maximum time for use of takeoff power, cylinder head and barrel and oil temperatures, minimum fuel octane number, etc. Give any limitation on r. p. m. due to vibration, tip speed, etc.; also propeller pitch, cowl flap position limitations, etc. The items should be listed as follows:

(i) *Engine:*

- (a) Manufacturer.
- (b) Model.
- (c) Propeller drive gear ratio.
- (d) Fuel; minimum octane.
- (e) Temperatures. Maximum permissible cylinder head and oil inlet.

(f) Power limits. Those given by the engine specification; i. e., excluding the effect of ram on critical altitude.

(g) Any limitations, such as r. p. m. ranges in which operation is prohibited due to engine or propeller vibration.

(ii) *Propellers.*

- (a) Manufacturer.
- (b) Model designation.

(iii) *Instrument markings.* An explanation of the instrument markings should be included. A typical example follows:

(a) *General.* Red radial line—Maximum and minimum limits. Yellow arc—Takeoff and precautionary ranges. Green arc—Normal operating ranges. Red arc—Ranges in which operation is prohibited.

(b) Fuel quantity indicator (When applicable—Reference sec. 4b.736). Red arc—Fuel which cannot be used safely in flight.

(4) *Speed limitations.* The speeds and explanations of their significance given in subdivisions (i) through (vi) of this subparagraph should be included. Section 4b.710 does specify whether airspeed limitations should be expressed in terms of calibrated or indicated airspeed. However, to agree with past practice it is suggested that the airspeed values be expressed in terms of calibrated airspeed. The indicated airspeed values may also be included, but should be properly identified, e. g. by parentheses.

[(i) *Maximum operating limit speed,  $V_{MO}/M_{MO}$ .* In accordance with section 4b.741 (a)(1), the manual should include a statement

that the maximum operating limit speed shall not be deliberately exceeded in any regime of flight (climb, cruise, or descent), except where a higher speed is authorized for flight test or pilot training operations.]

## (ii) [Deleted.]

(iii) *Maneuvering speed.  $V_A$ ,* plus a statement of its significance, of which the following is an example: "Maximum use" of the primary flight controls should be confined to speeds below this value. For this purpose, "Maximum use" is defined as the lesser of the following: Rudder—full throw, or \_\_\_\_\_ pounds force. Elevator—full throw, or \_\_\_\_\_ pounds force. Aileron—full throw, or \_\_\_\_\_ pounds force with each hand.

(iv) *Flaps extended speed.* At least the  $V_{FE}$  speed determined in accordance with section 4b.714 must be given. However, when desired, speeds for various combinations of flap settings and power conditions may be given, the following is an example:

<i>Flap setting</i>	<i>Maximum speed (m. p. h.)</i>	<i>Maximum power</i>
Takeoff		Takeoff
Approach-----	}	Continuous
		Takeoff
Landing-----	}	Idling
		Takeoff

(A note should be added to indicate which of the values is to be marked on the airspeed indicator.)

(v) *Landing gear operating speed.  $V_{LO}$ ,* plus a statement that this is the maximum speed at which the landing gear may be lowered or raised.

(vi) *Landing gear extended speed.  $V_{LE}$ ,* plus a statement that this is the maximum speed with landing gear extended and locked.

[(vii) *Compressibility effects.* Where a speed limitation (e.g.,  $M_{MO}$ ) is based on compressibility effects, the manual should include information concerning warning symptoms, probable behavior of the airplane, and recovery procedures.

[(viii) *Airspeed and Mach indicator markings and placards.* An explanation of any markings, limit hands, placards, etc., provided in complying with section 4b.732, should be included.]

(5) *Demonstrated crosswind.* The statement on this item should indicate the maximum cross component of wind velocity at which it has been demonstrated to be safe to take off or land. If the value established during the tests is considered the maximum up to which it is considered safe to operate the airplane on the ground, including takeoffs and landings, it should be entered under this item; i. e., as a limitation. However, if the value established is not considered limiting it should be included as Performance Information, as outlined in paragraph (d) of this section, instead of a limitation. In the case of flying boats an additional maximum cross component of wind velocity for taxiing may be appropriate material. Crosswind should be based on reported wind velocities measured at 50 feet above the ground.

(6) *Flight load acceleration limits.* Flaps up \_\_\_\_\_ (at takeoff weight). Flaps down \_\_\_\_\_ (at landing weight).

(7) *Type of airplane operation.* A typical example would be as follows:

(i) Transport category.

(ii) Instrument night flying (when required equipment is installed).

(iii) Atmospheric icing conditions—should stipulate “none, trace, light, moderate or heavy.”

(8) *Minimum crew.* Information should be given in this item for all operations specified under subparagraph (7) of this paragraph and any additional conditions if desired or considered pertinent. The number and identity of members of minimum crew necessary to safe operation should be stated.

(9) *Miscellaneous.* This item should include any information not given under the preceding headings that is restrictive and considered necessary for the safe operation of the airplane. Some typical examples are as follows:

(i) The wing and tail anti-icing heaters should not be operated in flight when the outside air temperature is above 50° F.

(ii) Pressurized cabin differential pressure limits, etc.

(iii) A notation should be included to warn flight personnel against jettisoning fuel while the flaps are lowered unless it has been demonstrated that flap position does not ad-

versely affect fuel jettisoning. (See sec. 4b.437 (b).)

(iv) Propeller reversing to be used for taxiing only.

(v) The windshield temperature limits or head adjustment setting should be specified if resistance to bird penetration is dependent upon operation within a particular windshield temperature range.

(c) *Operating procedures—general.* This section of the manual should contain information peculiar to the airplane, concerning normal and emergency procedures, knowledge of which might enhance the safety of operation of the airplane. The manual should state that these procedures are not made mandatory by Part 4b. However, they may be made mandatory by other parts of the regulations such as Parts 40, 41, 42, etc., of this subchapter.

(1) *Normal procedures.* This section should contain information and instructions regarding peculiarities of: Starting and warming engines, taxiing, operation of wing flaps, landing gear, automatic pilot, etc. Outline normal procedures for each, noting any special precautions in the interests of safety. Describe or refer to procedure in any emergency likely to occur in each. Also included in this section should be instructions for the operation of any equipment that is considered new in the aeronautical field or comparatively complicated.

(i) A typical example of the former would be: “Wing flaps should be exercised through three complete cycles prior to all initial takeoffs. This operation accomplishes the automatic bleeding and the equalization of pressure to the eight separate hydraulic flap actuating cylinders.”

(ii) Typical examples of the latter are: “Recommended operating procedures for thermal ice prevention system, recommended operating procedures for reversible pitch propellers, and cabin pressurization.”

(2) *Emergency procedures.*

(i) *Engine failure.* This section should include the procedure to be used in the event of an engine failure, including recommended minimum speeds, trim, operation of remaining engine(s), etc. A typical example would be as follows: “ENGINE FAILURE ON TAKE-OFF. The minimum speed ( $V_1$ ) at which the

airplane can be controlled directionally on the runway with an outboard engine inoperative and its propeller windmilling, and with takeoff power on the remaining engines, is 60 m. p. h. CAS. The minimum speed at which the airplane is controllable in flight with the sudden failure of an outboard engine, with takeoff power on the remaining engines, is 96 m. p. h. CAS. If an engine fails during the ground roll below speed  $V_1$ , cut the throttles on all engines and apply brakes. If ground contact has already been broken, land straight ahead if sufficient runway remains. If not, retract landing gear, maintain full power on live engines, and continue takeoff. Feather the dead engine as outlined in subdivision (ii) of this subparagraph. Use minimum cowl flap setting on live engines to maintain cylinder temperatures within limits. Retrim airplane as necessary. Speed for best climb under these conditions is 115 m.p.h. CAS. See paragraph (d) *Performance information*, of this section for criterion and  $V_1$  speeds used in determining the runway lengths."

(ii) *Propeller feathering*. This section of the manual should outline the procedure to be followed in stopping the rotation of propellers in flight. A typical procedure is outlined below:

(a) Throttle—"CLOSED."

(b) Push feathering switch button.

When propeller blades are fully feathered the button will kick out automatically.

(c) Mixture control—"IDLE CUT-OFF."

(d) Fuel and oil fire wall shut-off switches—"OFF" (closed).

(e) Cowl flaps—"CLOSED."

(f) Fuel booster pump—"OFF."

(g) Tank selector for engine being feathered—"OFF". (Do not shut tank selector "OFF" if crossfeed is being used.)

(h) Ignition for dead engine—"OFF."

(i) Propeller pitch control—"FULL DECREASE RPM."

(iii) *Automatic propeller feathering*.

(iv) *Unusual procedures*. Information on any emergency procedures that are considered unusual or in which a specific sequence of events are required to accomplish the operation

satisfactorily should be specified. Some typical examples are as follows:

(a) All-engine go-around when it is recommended practice to retract the flap prior to retracting the gear resulting from a design condition in which the flap creates more drag than the landing gear.

(b) Fire control procedures.

(c) Emergency cabin depressurization.

(d) Emergency landing gear extension.

(e) Emergency brake operation.

(f) Fuel dumping.

(g) *Electrical*. In addition to other electrical items, the manual should specify the circuits in which overriding breakers, if any, are used and contain instructions concerning operation of both overriding and non-overriding types. The following is a typical example: "All circuit breakers are of the non-overriding type except the fuel booster pumps and propeller feathering circuits. In an emergency, the breakers in these two circuits may be held closed with the possible risk of fire hazard due to short circuits, etc. Discretion should also be used in repeatedly resetting non-overriding breakers due to the fact that resetting may reestablish an arc and increase the fire hazard."

(h) Emergency by day and/or night.

(i) Flare release procedure.

(j) Wheels up landing procedure.

(k) Ditching procedure.

(3) *Other special operating procedures (if any)*.

(4) *Alternate operating procedures*. After gaining a large amount of experience with a particular model airplane, some operators may develop various operating procedures that they consider equivalent or better than some of those originally described in the manual. If an operator wants to incorporate new procedures in the Airplane Flight Manual, the operator should apply to the FAA office in the region where he is located for approval of the alternate procedures in the same manner that he would normally use in the case of a structural change or alteration. The local FAA regional office will coordinate the application with the FAA regional office containing the airplane technical data file if the proposed change in procedure is considered to be of sufficient importance.

(i) *For scheduled air carrier operators only.* For greater flexibility and to avoid duplication of instructions to pilots when operators desire to incorporate Airplane Flight Manual Operating Procedures in their operations manuals or devise their own operating procedures, the FAA will permit the removal of the Operating Procedures Section from the Airplane Flight Manual by scheduled air carrier operators provided the operators include the same or equivalent material in their operations manual and at the same time assume full responsibility of proving the equivalency of any new or altered procedures if called upon to do so by the FAA in connection with airplane accident investigations, etc. When the Operating Procedures Section is removed from the Airplane Flight Manual by an operator, an appropriate notation to this effect should be added to the Airplane Flight Manual of each airplane affected.

In accordance with the foregoing, the following statement should be included under the Operating Procedures Section of the Airplane Flight Manual when the Operating Procedure Section is transferred verbatim from the Airplane Flight Manual to the air carrier operations manual:

"The airplane operating procedures prescribed by section 4b.742 'Operating Procedures' are included in \_\_\_\_\_

(Show reference to appropriate

-----  
 section of the air carrier operations manual)

If an air carrier operator desires to reword or restate the FAA approved operating procedures or establish new or alternate operating procedures without obtaining prior approval of these procedures from the FAA, the following additional statement should be included with the above statement:

"Where the procedures in the air carrier operations manual differ from those contained in the FAA Approved Airplane Flight Manual for this airplane, \_\_\_\_\_

(Name of air carrier operator)

has determined that equivalent safety is provided by such alternate procedures and assumes full responsibility for this determination."

If for any reason the alternate operating procedures become inapplicable or inappropriate

to the operation of the airplanes affected, the original FAA Approved Operating Procedures Section should be reinserted in the Airplane Flight Manual in order that the contents of the manual will revert to the same text as originally approved by the FAA.

(d) *Performance information.* This section should contain all the performance information necessary to implement the operating requirements of Part 40 of this subchapter, and to operate the airplane safely.

(1) *Introductory information.* This should include any general information or any pertinent descriptions of the conditions under which the performance data were determined. The following examples are considered typical and appropriate:

(i) All climb data are for standard atmospheric conditions.

(ii) The minimum effective takeoff runway lengths given in this section are defined as the longer "accelerate-stop distance" and the distance required to takeoff and clear a 50-foot obstacle with one engine becoming inoperative at speed  $V_1$ .

(a) The accelerate-stop distance is the distance required to accelerate the airplane from a standing start to the speed  $V_1$ , and assuming an engine to fail at this point, to stop.

(b) The takeoff distance is defined as the sum of the following: Distance to accelerate to speed  $V_1$  with all engines operating, distance to accelerate from speed  $V_1$  to speed  $V_2$  with one engine inoperative and propeller windmilling in low pitch (it is assumed that gear retraction is initiated at the end of this segment), and the horizontal distance traveled in climbing to a height of 50 feet at speed  $V_2$  with one engine inoperative. (It is assumed that propeller feathering is not commenced prior to the end of this segment.)

(c) Speed  $V_1$  is defined as the critical engine failure speed and is a speed at which the controllability has been demonstrated to be adequate to permit proceeding safely with the takeoff when the critical engine is suddenly made inoperative. The minimum  $V_1$  speed for this airplane is 60 m. p. h. CAS (airspeed calibration should include ground effect), however, as explained below, speeds in excess of this value were used in determining the runway lengths.

(d) Speed  $V_2$  is defined as the minimum takeoff climb speed and is the greater of the following: 1.15 times the power-off-stalling speed with the flaps in the takeoff position (assuming a four-engine airplane). 1.10 times the minimum control speed,  $V_{MC}$ .

(e) The minimum control speed,  $V_{MC}$ , is defined as the minimum speed at which the airplane is controllable in flight with the sudden failure of an outboard engine with takeoff power on the remaining engines.

(f) All runway lengths given in this manual are based upon optimum  $V_1$  speeds; i. e., the speed selected for  $V_1$  is such that the accelerate-stop distance is equal to the distance to clear a fifty foot obstacle with one engine becoming inoperative at this speed. Consequently,  $V_1$  varies with weight, altitude, wind, gradient, temperature, etc. Values for  $V_1$  for the various conditions are given under (2) below.

(g) All takeoff and landing distances are given for dry, concrete runways.

(h) If the maximum cross component of wind velocity in which landings and takeoffs were demonstrated was not considered limiting, it should be included in this section of the manual. A typical example would be as follows: "The maximum crosswind component in which this airplane has been tested is 20 m. p. h. measured at a height of 50 feet above the ground. Consequently, in determining the effective takeoff and landing runway lengths, a crosswind component greater than this value may not be used."

(2) *Performance data.* These data may be given in either graphical or tabular form and should cover the weight range and all airport and terrain altitudes at which the airplane is intended to be operated. The scale of the charts should permit accurate reading within approximately 0.25 of one percent. The following should be included:

(i) *Airspeed calibration.* This should be given for the normal and alternate static sources. Ground effect should be included for  $V_1$  speed range. (A plot of CAS vs. IAS at various flap positions, preferably on one page.)

(ii) *Altimeter calibration.* This should be given for the normal and alternate static source.

(iii) *Stalling speeds.* A table or diagram of calibrated stalling speeds at various weights

at all authorized flap settings, power-off should be given.

(iv) *Gross weight summary.* A summary of permissible operating landing and takeoff gross weights as limited by the climb or structural requirements should be provided.

(v) *Minimum takeoff runway length.* Unless optimum values of  $V_1$  are selected, establishing equal distances to accelerate to speed  $V_1$  and stop or to make a takeoff over a 50-foot obstacle with the critical engine becoming inoperative at speed  $V_1$ , inclusion of both the accelerate-stop distance and runway length required to takeoff and clear a 50-foot obstacle will be necessary. It is recommended that these data be given for a range of temperatures (see sec. 4b.117) and runway gradients sufficient to permit proper dispatching under the rules of Part 40 of this subchapter, etc., in addition to the standard day temperature data.

(vi) *Takeoff information.* Takeoff flight paths through the final climb segment, flight path slope or data supplementary to that obtained in subdivision (v) of this subparagraph that may be used for dispatching purposes should be included. These should be for the same range of temperatures (see sec. 4b.117) and runway gradients as subdivision (v) of this subparagraph.

(vii) *Minimum takeoff climb speed,  $V_2$ .* This speed should be listed for the range of weights, altitudes and conditions covered in subdivisions (v) and (vi) of this subparagraph. The distance to accelerate to these speeds should also be included to provide data necessary for gradient problems involving runways with variable gradients of sufficient magnitude that average gradients cannot be assumed.

(viii) *Critical engine failure speed,  $V_1$ .* This speed or speeds  $V_1$  for the range of weights, altitudes and conditions covered in subdivisions (v) and (vi) of this subparagraph if applicable should be given. The distances to accelerate to these speeds should also be included to provide data necessary for gradient problems involving runways with variable gradients of sufficient magnitude that average gradients cannot be assumed.

(ix) *Minimum runway length required for landing.* With respect to this item, the following data would be considered appropriate:

Landing distance from height of 50 feet. Minimum effective landing runway length—scheduled stops. (See Part 40 of this subchapter.) Minimum effective landing runway length—alternate stops. (See Part 40 of this subchapter.)

(x) *Wind effect in landing and takeoff.*

If it is desired to take advantage of wind in determining landing and takeoff distances all data should be based upon wind velocities reported at a height of 50 feet above the runway; i. e., the runway length would be calculated for one-half of the reported headwind velocity, or one and one-half times the reported tailwind velocity, measured at a height of 50 feet corrected for wind gradient to the height of the center of aerodynamic drag of the airplane. A note clearly stating the above stipulations should be included in the manual.

(xi) *Rates of climb and climbing speeds.*

These rates and speeds should be specified for the desired range of weights and altitudes, together with the corresponding airplane configuration (flap position, gear position, etc.), and should be given for the following when applicable:

- (a) First segment takeoff climb (sec. 4b.120 (a)).
- (b) Second segment takeoff climb (sec. 4b.120 (b)).
- (c) Third segment takeoff climb (sec. 4b.116 (d)).
- (d) Final segment takeoff climb (sec. 4b.116 (e)).
- (e) One-engine inoperative en route climb (sec. 4b.120 (c)).
- (f) All-engine en route climb (sec. 4b.119 (a)).
- (g) Two-engine inoperative en route climb (sec. 4b.121).
- (h) Approach climb (sec. 4b.120 (d)).
- (i) Landing climb (sec. 4b.119 (b)).

(xii) *Engine power curve.* A copy of the FAA approved power chart of BHP vs. MP at RPM and BHP vs. altitude at RPM and at MP should be included.

(xiii) *Performance charts.* Any instructions or examples for use of the performance charts should be included.

(xiv) *Removal of performance data.* The Performance Section of the Airplane Flight

Manual should not be removed from the Airplane Flight Manual. However, any tables, charts, etc., that an air carrier operator prepares which are based on airplane flight manual performance material for convenience in determination of load limitation data need not be carried in the Airplane Flight Manual even though approved by the FAA if the operator does not care to do so.

(e) *Weight and balance data.*

(1) *General.* Inasmuch as it is desired to eliminate the necessity of submitting revisions of the Airplane Flight Manual to the FAA for approval whenever an item of equipment is altered or added, this section of the manual will not be included in the formally "approved" portion of the document. However, a note to the effect that the airplane should be operated in accordance with the approved loading schedule should be included in the Limitations section. (See paragraph (b)(1) of this section.)

(2) *Responsibility for control of weight and balance.* It is the intention of the Federal Aviation Agency to place the responsibility for the control of weight and balance with the manufacturer and operator. The manufacturer will furnish a weight and balance report for each new airplane which may be included in the manual but not in the "approved" portion. The Federal Aviation Agency's representative will not approve each individual report but will make only occasional spot checks to ascertain that the manufacturer's weight control procedure is adequate. The manufacturer will be expected to furnish complete information with the airplane not only regarding its actual weight and balance, but also to include sketches, samples and other data that will assist the operator in checking the balance after alterations.

(3) *Conventional airplanes.* The following material is believed to be complete and adequate for a conventional airplane.

(i) *Weight limits.* A list and explanation (where necessary) of the various weight limits should be given.

(ii) *C. G. limits.* The approved operating c. g. range should be specified.

(iii) *Empty weight and empty weight c. g. location.*

(iv) *Equipment list.* All equipment included in the empty weight should be listed.

(v) *Weight computations.* The computations necessary to determine the empty weight c. g. location, including identification of balance datum should be shown.

(vi) *Loading schedule.*

(vii) *Loading schedule instructions.* Complete instructions in the use of the loading schedule should be provided.

(4) *Unconventional airplanes.* In the case of unconventional airplanes or airplanes with special features, the information specified in subparagraph (3) of this paragraph should be modified or amplified as necessary to cover the case.

(f) *Supplements.* As a general rule, when major alterations are made by an operator (or owner) to an airplane involving appreciable changes to the Airplane Flight Manual it is advisable for the operator to prepare a separate supplement to the original manual under his own name covering the items that are different from the original manual. Then subsequent revisions to the manual by the manufacturer or operator will pertain only to their respective portions of the manual and should eliminate possible confusion.

(g) *Submittal.* Three copies of the above material, less the Weight and Balance Data Section, should be submitted to the appropriate Federal Aviation Agency regional office by the applicant for an original approval. The three copies will be signed by the regional Chief, Engineering and Manufacturing Branch; one copy will be returned to the applicant, one will be forwarded to the Washington office and the other retained by the regional office. A single copy of the title page to be used for the Chief's signature may be substituted for the applicant's copy if desired. In cases where the revisions to the manual are of primary importance to safety in flight, the pertinent Aircraft Specification will contain a description of the change to ensure that all manuals are revised. A revision of this type would usually be the subject of an Airworthiness Directive note. One copy of the Weight and Balance Section should be included in the manual by

the applicant for each airplane at the time of certification.

(16 F. R. 1052, Feb. 6, 1951, effective Feb. 6, 1951; amended 19 F. R. 4446, July 20, 1954, effective Sept. 1, 1954; 23 F. R. 7482, Sept. 26, 1958, effective Oct. 20, 1958; 27 F. R. 2986, Mar. 30, 1962, effective May 3, 1962.)

4b.740-2 *Reverse thrust operating limitations and procedures (FAA policies which apply to sec. 4b.740).* The policies outlined in section 4b.402-1 (b) will apply.

(20 F. R. 2281, Apr. 8, 1956, effective Apr. 30 1956.)

#### 4b.741 *Operating limitations.*

(a) *Airspeed limitations.* The following airspeed limitations shall be included together with sufficient information to permit the presentation of the airspeed limitations to the flight crew in accordance with section 4b.732;

[ (1) The maximum operating limit speed  $V_{MO}/M_{MO}$  (see sec. 4b.711), together with a statement that this speed limit shall not be deliberately exceeded in any regime of flight (climb, cruise, or descent), except where a higher speed is authorized for flight test or pilot training operations. ]

(2) [Deleted.]

(3) When an airspeed limitation is based upon compressibility effects, a statement to this effect, together with information as to any symptoms, the probable behavior of the airplane, and the recommended recovery procedures;

(4) The maneuvering speed (see sec. 4b.210 (b) (2)), together with a statement to the effect that full application of rudder and aileron controls as well as those maneuvers which involve angles of attack near the stall should be confined to speeds below this value;

(5) The flap extended speed (see sec. 4b.714), together with a description of the pertinent flap positions and engine powers;

(6) The landing gear operating speed (see sec. 4b.715), together with a statement to the effect that this is the maximum speed at which it is safe to extend or retract the landing gear;

(7) The landing gear extended speed (see sec. 4b.716), if greater than the landing gear operating speed, together with a statement to the effect that this is the maximum speed at



which the airplane can be flown safely with the landing gear in the extended position.

(b) *Powerplant limitations.* Information shall be included to outline and to explain all powerplant limitations (see sec. 4b.718) and to permit marking the instruments as required by sections 4b.734 through 4b.736.

(c) *Weight and loading distribution.* The airplane weights and center of gravity limits required by sections 4b.101 and 4b.102 shall be included, together with the items of equipment on which the empty weight is based. Where the variety of possible loading conditions warrants, instructions shall be included to facilitate observance of the limitations.

(d) *Flight load acceleration limits.* The positive maneuvering limit load factors for which the airplane structure has been proven shall be described in terms of accelerations, together with a statement to the effect that these accelerations limit the angle of bank in turns and limit the severity of pull-up maneuvers.

(e) *Flight crew.* The number and functions of the minimum flight crew determined in accordance with section 4b.720 shall be described.

(f) *Type of operation.* The type(s) of operation(s) shall be listed for which the airplane and its equipment installations have been approved. (See sec. 4b.721.)

(g) *Maximum operating altitude.* The altitude established in accordance with section 4b.722 shall be included, together with an explanation of the limiting factors.

[(Amendment 4b-12, published 27 F. R. 2986, Mar. 30, 1962, effective May 3, 1962.)]

#### 4b.742 *Operating procedures.*

(a) *Normal.* Information and instructions shall be included regarding peculiarities of starting and warming the engines, taxiing, operation of wing flaps, landing gear, automatic pilot, etc.

(b) *One engine inoperative.* The recommended procedure shall be described to be followed in the event of engine failure, including minimum speeds, trim, operation of remaining engine(s), operation of flaps, etc.

(c) *Propeller feathering.* The recommended procedure shall be described to be

followed in stopping the rotation of propellers in flight.

(d) *Restarting of turbine engines.* The recommended procedures to be followed in restarting turbine engines in flight shall be described. These procedures shall include the effects of altitude.

(e) *Emergency procedures.* Recommended emergency procedures shall be described to be followed in the event of fire, decompression, ditching, etc.

#### 4b.743 *Performance information.*

(a) *Performance data.* A summary of all pertinent performance data shall be given, including the performance data necessary for the application of the operating rules of this subchapter, together with descriptions of the conditions, airspeeds, etc., under which these data were determined.

(b) *Flap controls.* Instructions shall be included describing the use and adjustment of the flap controls necessary to obtain the performance referred to in paragraph (a) of this section.

(c) *Airspeeds.* The indicated airspeeds corresponding with those determined for take-off shall be listed together with the procedures to be followed in the event the critical engine becomes inoperative during takeoff (see sec. 4b.742 (b)).

(d) *Miscellaneous.* An explanation shall be included of any significant or unusual flight or ground handling characteristics.

### Airplane Identification Data

4b.750 *Identification plate.* A fireproof identification plate shall be securely attached to the structure in an accessible location where it will not likely be defaced during normal service. The identification plate shall not be placed in a location where it might be expected to be destroyed or lost in the event of an accident. The identification plate shall contain the identification data required by section 1.50 of this subchapter.

4b.751 *Identification marks.* The nationality and registration marks shall be permanently affixed in accordance with section 1.100 of this subchapter.

## Summary of Appendixes

APPENDIX A contains figures 1 through 9 which pertain to Civil Aeronautics Manual material. The figures pertaining to the Civil Air Regulations are included in that text.

APPENDIX B contains a list of the tests normally required to show compliance with the regulations (see sec. 4b.16-2 (a) (2)). The tests are divided into the following four groups: (1) Performance, (2) Flying qualities, (3) Powerplant tests, and (4) Functional and miscellaneous tests. Each item is referenced to its appropriate regulation. These regulations are given in numerical order in the text along with policy material and testing procedure for demonstrating compliance with the subject requirement.

APPENDIX C is a sample of typical flight test programs that would be necessary to substantiate changes in the airplane configuration, such as change in propeller, engine power, aerodynamic drag, etc. Obviously, a hard and fast rule cannot be set up to handle every case, and the required test program will vary depending upon the conditions surrounding each case as well as a consideration of any marginal conditions existing in the original design (see sec. 4b.16-2 (a) (5)).

APPENDIX D presents a general order of testing that has been found convenient from past experience in flight testing. This is presented only as a general guide (see sec. 4b.16-2 (b)).

APPENDIX E has been prepared to facilitate the development of a flight test schedule, by grouping the individual tests according to weight and center-of-gravity location (see sec. 4b.16-2 (c) (1)).

APPENDIX F contains a list of only those tests requiring special instrumentation and a description of pertinent instrument(s) (see sec. 4b.16-2 (c) (2)).

APPENDIX G contains Special Civil Air Regulations pertinent to Part 4b.

APPENDIX H contains procedures which are acceptable to the FAA for showing compliance with the fatigue evaluation requirements of Civil Air Regulation 4b.270.

APPENDIX I gives environmental test procedures for electrical equipment.

### Abbreviations Used in Appendixes

Alt.—Altitude	M. P. H.—Miles per Hour
Appr.—Approach	O. A. T.—Outside Air Temperatures
App.—Appropriate	Oper.—Operating
C. G.—Center of Gravity	Opt.—Optional
Crit.—Critical	Prop.—Propeller
Eng.—Engine	R/C—Rate of Climb
Ext.—Extended	Req'd.—Required
Feath.—Feathered	Retr.—Retracted
F.T.—Full Throttle	Stab.—Stability
Fwd.—Forward	Stat.—Static
Inop.—Inoperative	Temp.—Temperature
Land.—Landing	Thrott.—Throttle
Long.—Longitudinal	T. O.—Takeoff
Max. Cont.—Maximum Continuous	Wt.—Weight
M. P.—Manifold Pressure	

## Appendix A

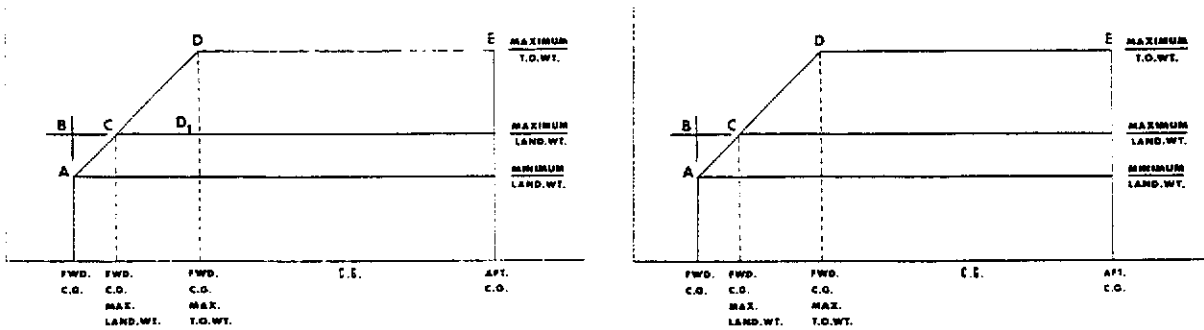

Figure 1.—Weight—c. g. positions.

**Case A.**—This case may be used when it is possible to conduct stalling speed tests at the c. g.-weight combinations in options (1) or (2) below provided the test weights are within the tolerance limits of 4b.100-1 (b) (2) for both maximum takeoff and minimum landing weights. In this case, stalling speeds for all flap positions may be calculated for the performance weight range from the stall test data at these weights.

**OPTION (1)**—For climb requirements based on stalling speed at most forward c. g. position.

- (a) Tests may be conducted at c. g.-weight combination only, that is, point "B".
- (b) In lieu of (a) tests should be conducted at c. g.-weight combination points "A" and "C".

**OPTION (2)**—For climb requirements based on stalling speed varying with c. g. position.

- (a) Tests should be conducted at c. g.-weight combination points "A", "C", and "D", in order to adequately establish the variation of stalling speed with c. g. position.

**Case B.**—This case should be used when the test weights shown in Case A do not fall within the tolerance limits of 4b.100-1 (b) (2) for both maximum takeoff and minimum landing weights. In this case stalling speeds for the retracted, en route, and takeoff flap should be calculated for the entire performance weight range from the stall test data of the highest weight tested, and stalling speeds for the approach flap should be calculated for the entire performance weight range from stall test data at the lower weights tested. Stalling speeds for the landing flap should be calculated for the entire performance weight range from stall test data at both weights. *Note.*—Both weights are necessary in this latter case since the en route climb requirement is based on stall speed for the landing flap setting and appropriate weight.

**OPTION (1)**—For climb requirements based on stalling speed at most forward c. g. position.

- (a) Tests may be conducted at two c. g.-weight combinations, that is, points "B" and "D".
- (b) In lieu of (a) tests should be conducted at c. g.-weight combination points "A", "C", and "D".

**OPTION (2)**—For climb requirements based on stalling speed varying with c. g. position.

- (a) Tests should be conducted at three or more equally spaced c. g.-weight combinations between points "A" and "D" in order to adequately establish the variation of stalling speed with c. g. position.

(22 F. R. 5792, July 20, 1957, effective Aug. 15, 1957.)

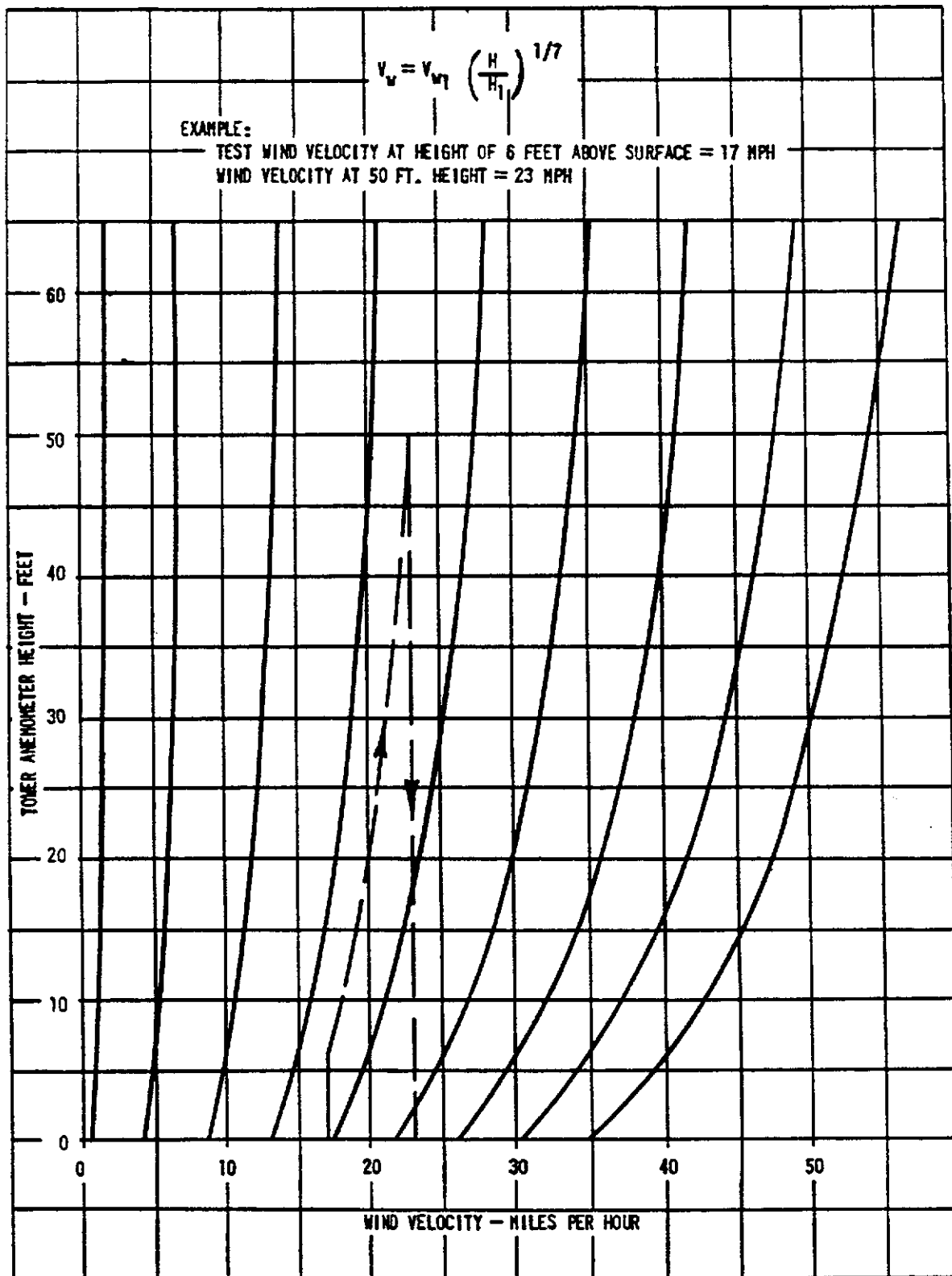

Figure 2. — Wind gradient correction.

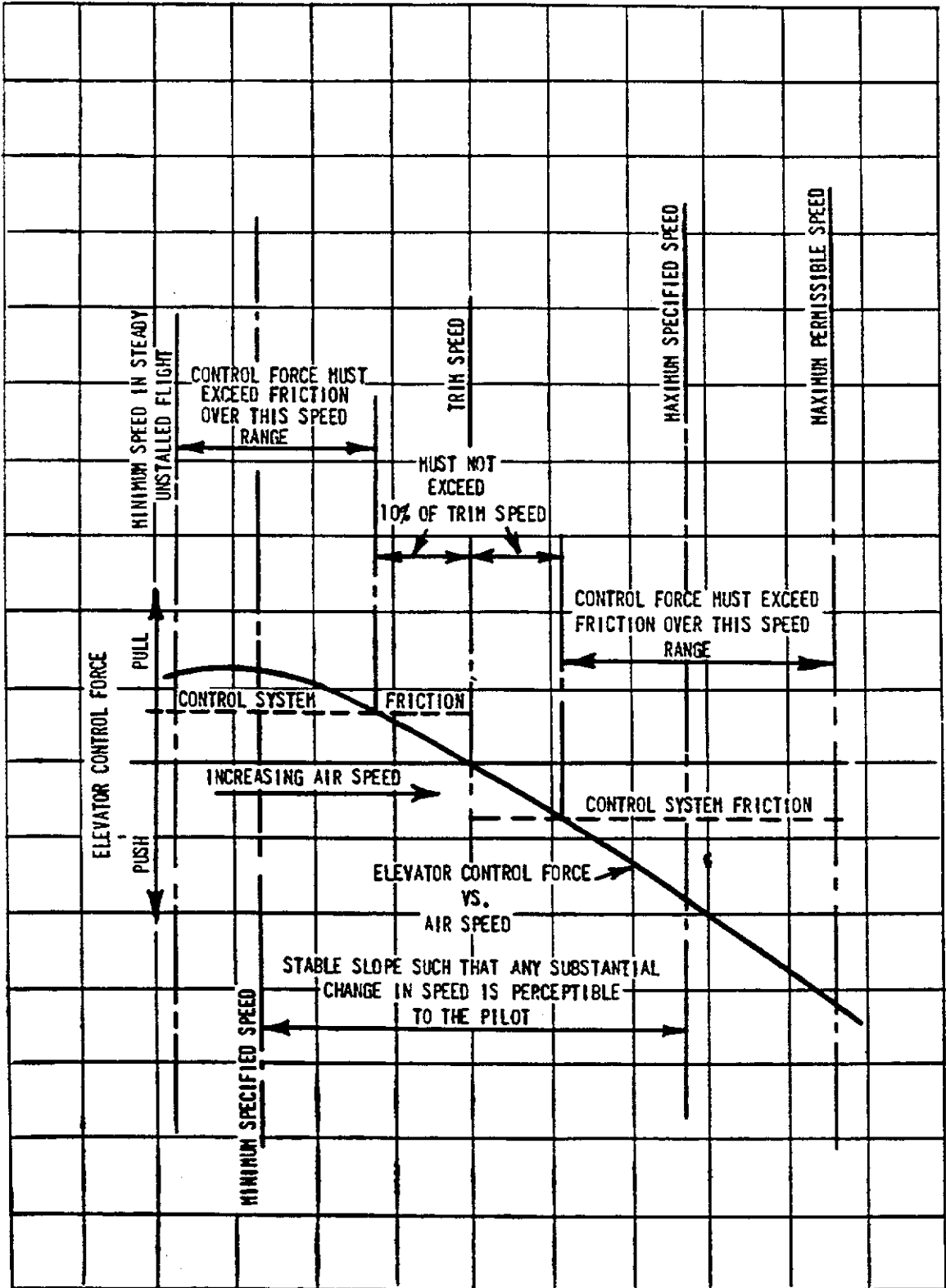

Figure 3.—Static longitudinal stability requirements.

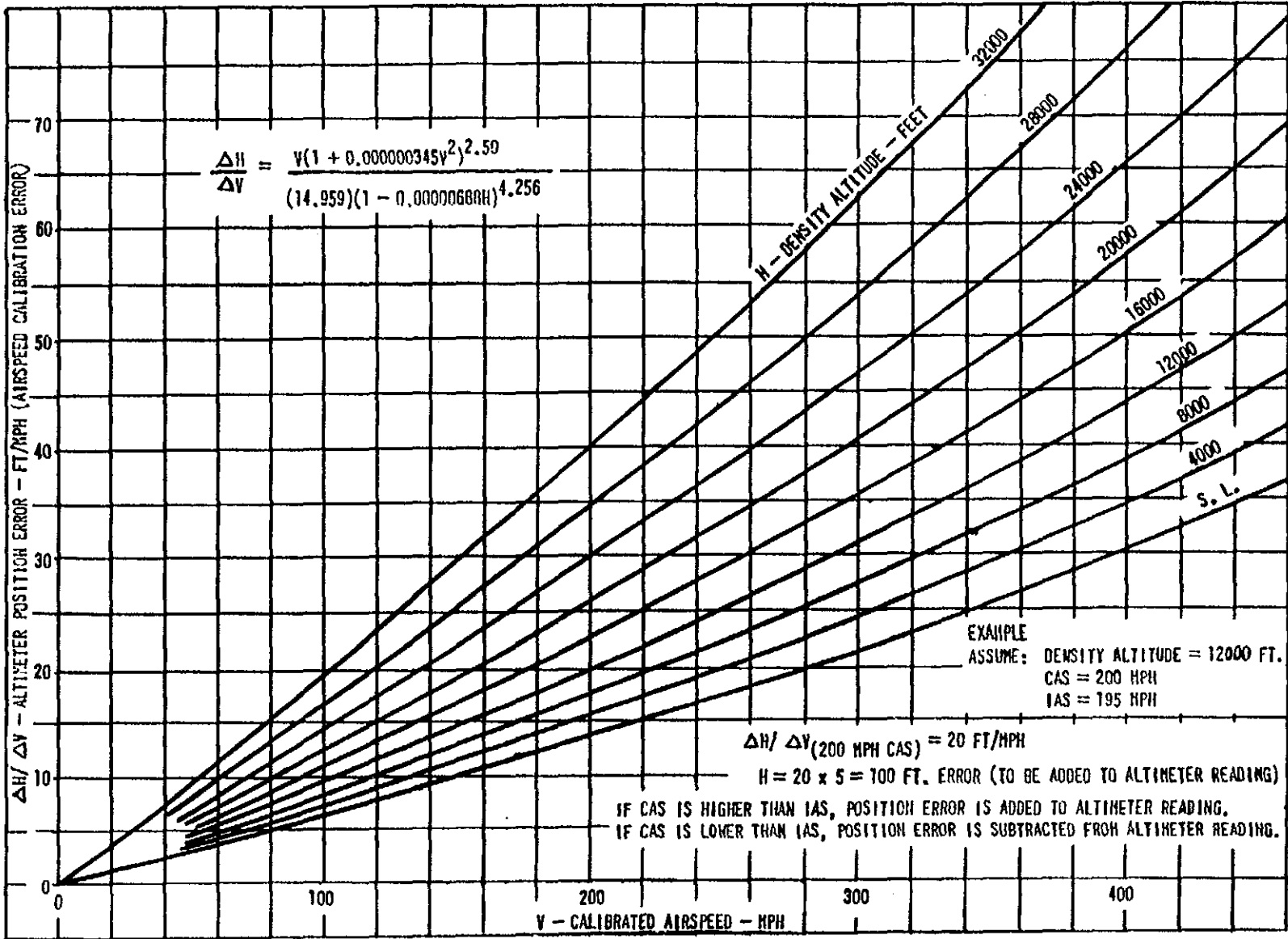

Figure 4.—Altimeter position error.

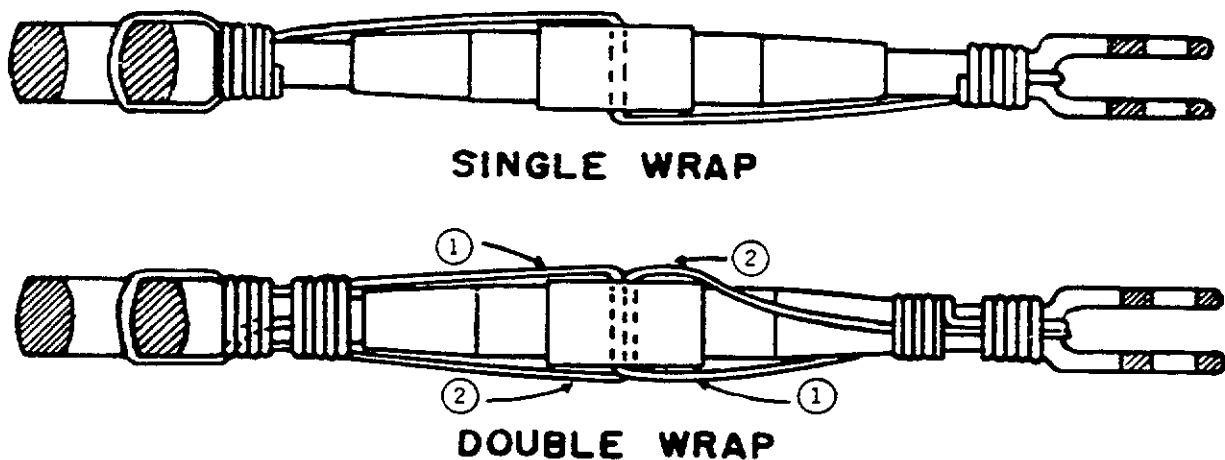

Figure 5.—Turnbuckle safety wiring.

1. Wire 1 is passed through the turnbuckle hole as shown, the two wire ends are passed through the right and left hand ends of the turnbuckle and are then bent back along the barrel of the turnbuckle.
2. Wire 2 is installed and wrapped (these wraps are next to the ends of the turnbuckle).
3. The two loose ends of wire 1 are then wrapped.





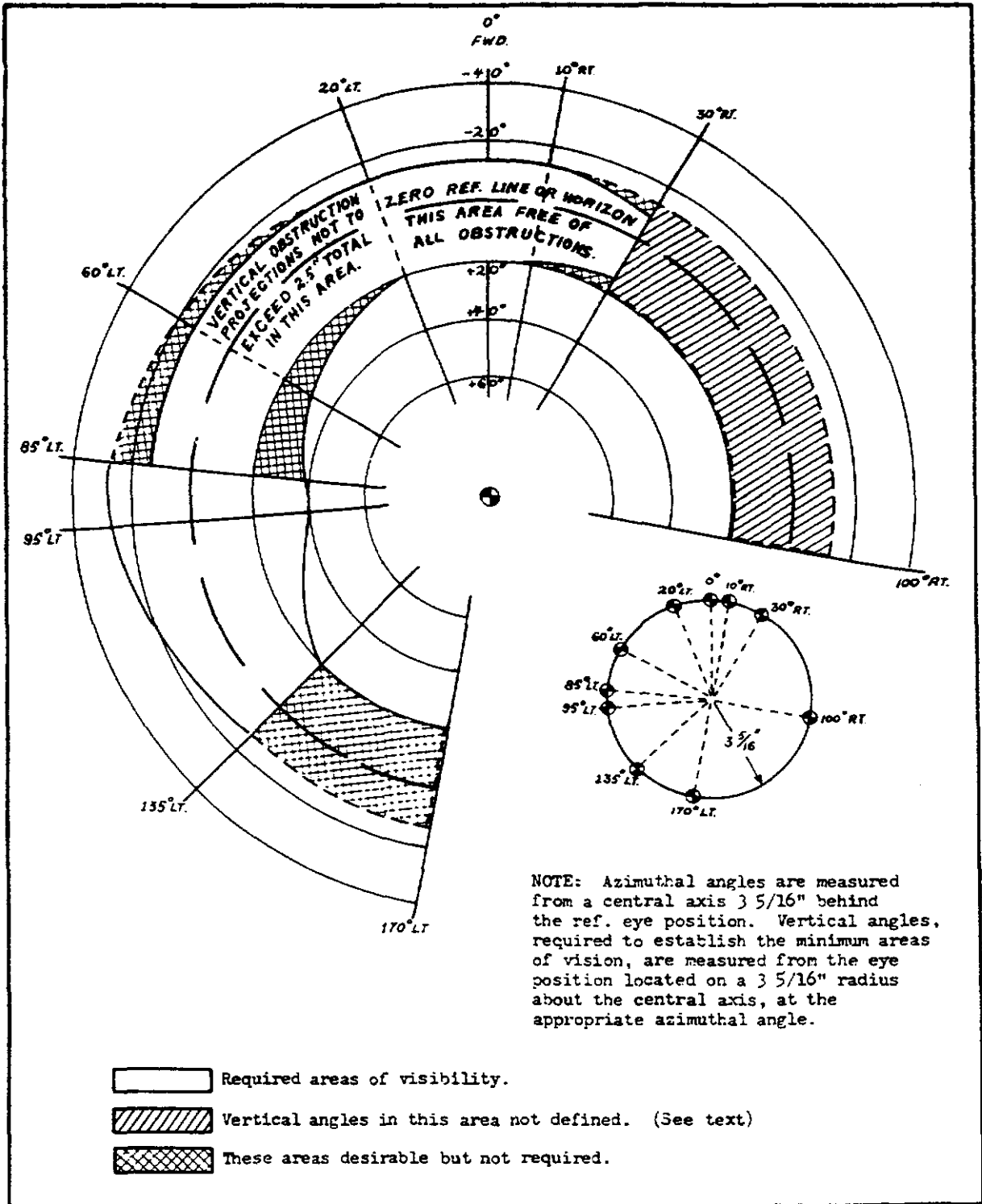

Figure 7.—Clear areas of vision.

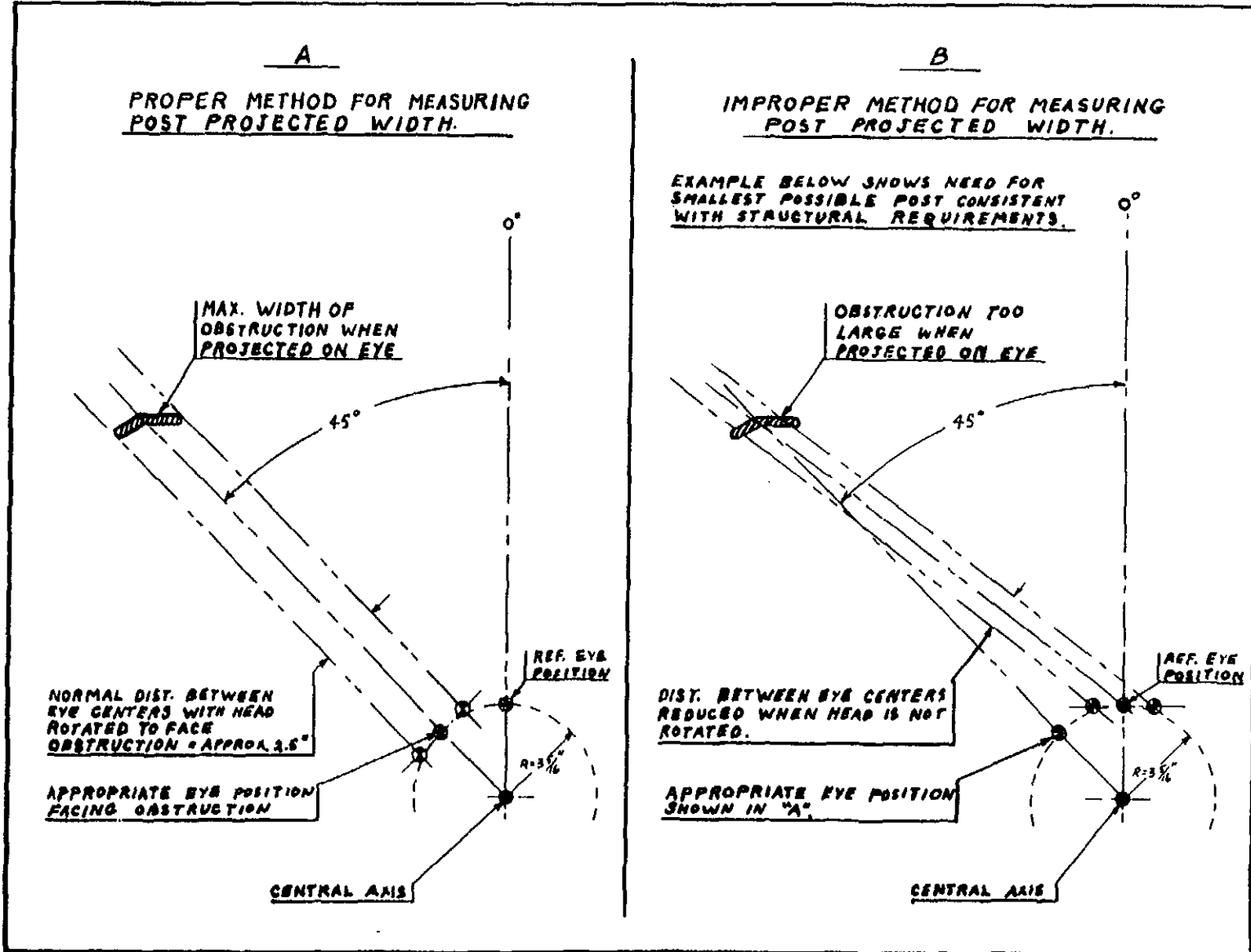

Figure 8.—Obstruction to vision.



## Appendix B Performance Tests

Item	CAR ref. No.	Test description	Wt.	O. G.	Altitude	Flap	Land- ing gear	Engines						Test	Special instrumentation
								Operating			Inoperative				
								Prop.	Power	Cowl flap	Prop.	Thrott.	Cowl flap		
1	§4b.612 (a)	Airspeed calibration	Be- tween max. T. O. and max. land.	Opt.	Opt. greater than one span length	Retr.	Retr.	Opt.	Opt.	Opt.				Airspeed indicating system should be calibrated over speed range from 1.3 $V_{st}$ to $V_{NO}$ or to max. cont. power whichever is lower.	Reference airspeed system or speed course.
		Ground speed calibration	T. O.			T. O.	Ext.	Opt.	Opt.	Opt.	Wind milling in T. O. pitch	Closed	T. O.	Airspeed indicating system should be calibrated during ground run between 0.8 minimum value of $V_1$ to maximum value of $V_1$ .	
2 (a)	§4b.110	Engine calibration T. O. power	Opt.	Opt.	Opt.	T. O.	Retr.	T. O.	T. O.	T. O.				Climb should be conducted at $V_1$ speed with appropriate M. P. until full throttle and then at F. T. through the desired altitude range for engine calibration data.	Instrumentation for measuring humidity.
		(b) Engine calibration max. cont. power	Opt.	Opt.	Opt.	All eng. en route climb	Retr.	Max. cont.	Max. cont.	All eng. en route climb position				Same as above procedure except climb should be conducted at en route climb speed.	
3	§4b.112	Stalling speeds	Max. land. or max. at req'd O. G. position	Most fwd or varying	Opt.	En route T. O. appr. land.	Retr. Retr. Ext.	Opt.	Zero thrust or less	Closed				Stalls should be conducted at each flap setting with not more than sufficient power for zero thrust at a speed not greater than 110% of the stalling speed.	Reference airspeed system or suitable calibrated system, instrument photo-recorder.
4	§4b.116	Accelerate to $V_1$ and stop distance	Max. T. O. and one lower	Most fwd <sup>1</sup>	S. L. to 2,000 ft.	T. O.	Ext.	T. O.	T. O.	T. O.	Wind- milling in T. O. pitch <sup>2</sup>	Closed	T. O.	Airplane should be accelerated to $V_1$ speed, all engines cut and brought to a stop.	Graphically recording vertical and horizontal distance-time instrumentation, wind velocity, direction and humidity meteorological instrumentation.
5	§4b.116 (a)	Accelerate to $V_1$	Max. T. O. and one lower	Most fwd	S. L. to 2,000 ft.	T. O.	Ext.	T. O.	T. O.	T. O.	Wind- milling in T. O. pitch <sup>2</sup>	Closed	T. O.	Airplane should be accelerated to $V_1$ one engine cut and acceleration continued to $V_2$ . (If $V_1$ is less than $V_2$ a demonstration takeoff should be made at max. T. O. weight conditions.)	Same as item 4.
6 (a)	§4b.120 (a)	Climb initial T. O. segment	Max. T. O. and one lower	Opt.	Two opt. altitudes	T. O.	Ext.	T. O. <sup>3</sup>	T. O. <sup>3</sup>	T. O.	Wind- milling in T. O. pitch <sup>2</sup>	Closed	T. O.	See §§ 4b.116-2 (b) (2) and 4b.118-1.	Instrumentation for measuring humidity.

For footnotes, see p. 212.

## Performance Tests—Continued

Item	CAR ref. No.	Test description	Wt.	C. G.	Altitude	Flap	Land- ing gear	Engines						Test	Special instrumentation
								Operating			Inoperative				
								Prop.	Power	Cowl flap	Prop.	Thrott.	Cowl flap		
6 (b)	§ 4b.120 (b)	Climb 2d T. O. segment	Max. T. O. and one lower	Opt.	Two opt. altitudes	T. O.	Retr.	T. O. <sup>1</sup>	T. O. <sup>2</sup>	T. O.	Wind- mulling in T. O. pitch <sup>3</sup>	Closed	T. O.	See §§ 4b.116-2 (b) (3) and 4b.118-1.	Instrumentation for measuring humidity—Con.
(c)	§ 4b.118 (d)	Climb 2d T. O. segment	Max. T. O. and one lower	Opt.	Two opt. altitudes	T. O.	Retr.	T. O. <sup>1</sup>	T. O. <sup>2</sup>	T. O.	Feath.	Closed	Opt.	See §§ 4b.116-2 (b) (4) and 4b.118-1.	
(d)	§ 4b.118 (e)	Climb 4th T. O. segment	Max. T. O. and one lower	Opt.	Two opt. altitudes	T. O.	Retr.	Max. cont.	Max. cont.	T. O.	Feath.	Closed	Opt.	See §§ 4b.116-2 (b) (5) and 4b.118-1.	
(e)	§ 4b.119 (a)	Climb cruising config. all engs.	Max. T. O. and one lower	Opt.	Two opt. altitudes	Opt.	Retr.	Max. cont.	Max. cont.	FAA hot day cooling position				See §§ 4b.118-1 and 4b.119-1 (a).	
(f)	§ 4b.120 (c)	Climb on route one eng. inop.	Max. T. O. and one lower	Opt.	Two opt. altitudes	Opt.	Retr.	Max. cont.	Max. cont.	FAA hot day cooling	Feath.	Closed	Opt.	See §§ 4b.118-1 and 4b.120-2 (c).	
(g)	§ 4b.121	Climb two engs. inop.	Two opt. wts.	Opt.	Two opt. altitudes	Opt.	Retr.	Max. cont.	Max. cont.	FAA hot day cooling	Feath.	Closed	Opt.	See §§ 4b.118-1 and 4b.121-1.	
(h)	§ 4b.120 (d)	Climb approach	Max. land. and one lower	Opt.	Two opt. altitudes	Appr.	Retr.	T. O. <sup>1</sup>	T. O. <sup>2</sup>	Appr.	Feath.	Closed	Opt.	See §§ 4b.118-1 and 4b.120-2 (d).	
(j)	§ 4b.119 (b)	Climb landing	Max. land. and one lower	Opt.	Two opt. altitudes	Land.	Ext.	T. O. <sup>1</sup>	T. O. <sup>2</sup>	Appr.				See §§ 4b.118-1 and 4b.119-1 (b).	
7	§ 4b.122 § 4b.123	Landing distance	Max. land. and one lower	Most fwd.	S. L. to 2,000 ft.	Land.	Ext.	Opt.	Opt.	Appr.				Landings over 50' obstacle should be conducted to establish the landing distance.	Same as item 4.

## NOTES

<sup>1</sup> C. G. should be in the most aft position for demonstration with reverse thrust propeller.  
<sup>2</sup> Tests involving takeoff power may be demonstrated using maximum continuous power if additional tests are run at a lower power to determine effects of slipstream.

<sup>3</sup> Propeller should be in feathered position if automatic feathering device is installed.

# Flying Qualities

CAM 4b

Item	CAR ref. No.	Test description	Wt.	O. G.	Altitude	Flap	Land- ing gear	Engines						Test	Special instrumentation		
								Operating			Inoperative						
								Prop.	Power	Cowl flap	Prop.	Thrott.	Cowl flap				
8 (a)	§ 4b.131 (a)	Long. control recovery to 1.4 V <sub>s1</sub> power on	Max. T. O.	Most aft	Opt.	Retr.	Ext.	Max. cont.	Max. cont.	Opt.	-----	-----	-----	Prompt recovery to 1.4 V <sub>s1</sub> should be demonstrated from any speed between V <sub>s1</sub> and 1.4 V <sub>s1</sub> when airplane is pitched down.			
			Max. land.			Ext.											
	§ 4b.131 (a)	Long. control recovery to 1.4 V <sub>s1</sub> power off	Max. T. O.	Most aft	Opt.	Retr.	Ext.	Opt.	Off	Opt.	-----	-----	-----			Same as test 8 (a).	
			Max. land.			Ext.											
	§ 4b.131 (b) (1)	Long. control sudden changes in flaps power off	Max. land.	Most fwd. and most aft	Opt.	Retr.	Ext.	Opt.	Off	Opt.	-----	-----	-----			One hand controllability should be demonstrated when flaps are extended rapidly without change in trim control.	
	§ 4b.131 (b) (2)	Long. control sudden changes in flaps power off	Max. land.	Most fwd. and most aft	Opt.	Ext.	Ext.	Opt.	Off	Opt.	-----	-----	-----			One hand controllability should be demonstrated when flaps are retracted rapidly without change in trim control.	
	§ 4b.131 (b) (3)	Long. control sudden changes in flaps power on	Max. land.	Most fwd. and most aft	Opt.	Ext.	Ext.	T. O.	T. O.	Opt.	-----	-----	-----			Test 8 (d) should be repeated with T. O. power.	
§ 4b.131 (b) (4)	Long. control sudden changes in power flaps retr.	Max. land.	Most fwd. and most aft	Opt.	Retr.	Ext.	Opt.	Off	Opt.	-----	-----	-----	One hand controllability should be demonstrated when T. O. power is applied quickly without change in trim control.				
§ 4b.131 (b) (5)	Long. control sudden changes flaps ext.	Max. land.	Most fwd. and most aft	Opt.	Ext.	Ext.	Opt.	Off	Opt.	-----	-----	-----	Test 8 (f) should be repeated with flaps extended.				
§ 4b.131 (b) (6)	Long. control variation in air-speed	Max. land.	Most fwd	Opt.	Ext.	Ext.	Opt.	Off	Opt.	-----	-----	-----	One hand controllability should be demonstrated throughout speed range of 1.1 V <sub>s1</sub> to 1.7 V <sub>s1</sub> or to V <sub>max</sub> without change in trim control.				
§ 4b.131 (c)	Long. control flap retraction	Max. land.	Most fwd. and most aft	Opt.	Ext.	Ext.	Opt.	Off	Opt.	-----	-----	-----	It should be possible to prevent altitude loss when flaps are retracted with simultaneous application of M. C. power.				
9 (a)	§ 4b.132 (a)	Directional control sudden changes in heading	Max. land.	Most aft	Opt.	Appr.	Retr.	Opt.	Power for level flight at 1.4 V <sub>s1</sub> but not more than max. cont.	Opt.	Feath.	Closed	Opt.	Satisfactory controllability should be demonstrated when sudden heading changes are executed in either direction with wings level.	Rudder force indicator if force is critical.		

APPENDIX B

Flying Qualities—Continued

Item	CAR ref. No.	Test description	Wt.	C. G.	Altitude	Flap	Land- ing gear	Engines						Test	Special instrumentation
								Operating			Inoperative				
								Prop.	Power	Cowl flap	Prop.	Thrott.	Cowl flap		
9 (b)	§ 4b.132 (b)	Directional control sudden changes in heading	Max. land.	Most fwd.	Opt.	Climb	Retr.	Opt.	Power for level flight at 1.4 V <sub>cr</sub> but not more than max. cont.	Opt.	Feath.	Closed	Opt.	Test 9 (a) should be repeated with 2 crit. engs. inop.	Same as item 9 (a).
(c)	§ 4b.132 (c)	Lateral control 20° banked turns	Max. T. O.	Most aft	Opt.	Climb	Retr. and ext.	Max. cont.	Max. cont.	Opt.	Feath.	Closed	Opt.	20° banked turns with and against inoperative engine should be demonstrated from steady climb at speed of 1.4 V <sub>cr</sub> .	Bank angle indicator.
(d)	§ 4b.132 (d)	Lateral control 20° banked turns	Max. land.	Most fwd.	Opt.	Climb	Retr.	Max. cont.	Power for level flight at 1.4 V <sub>cr</sub> but not more than max. cont.	Opt.	Feath.	Closed	Opt.	Test 9 (c) should be repeated with 2 crit. engs. inop.	Same as item 9 (c).
10	§ 4b.133	Minimum control speed	Max. T. O. or less if necessary	Most aft	Opt. below T. O. power crit.	T. O.	Retr.	T. O.	T. O.	T. O.	Wind- milling or any other logical position	Closed	T. O.	Minimum control speed should be determined when engine is suddenly made inoperative.	Same as item 9 (a). Bank indicator if bank is to be demonstrated.
11	§ 4b.180 § 4b.170 § 4b.171 § 4b.172 § 4b.173 § 4b.180 § 4b.181 § 4b.182	Control- ability, maneuver- ability and stability	App.	Opt. and noted	SEE APPROPRIATE REGULATIONS						Airplane should be demonstrated for: (1) Controllability (2) Attitude during ground roll (3) nose over tendency during takeoff, landing and ground operation (4) Direc- tional stability and control during power-off landings in cross winds and taxiing (5) Water handling characteristics.				
12 (a) (b)	§ 4b.115 § 4b.123 (a)	Control Reverse thrust operation of props.													
13	§ 4b.141	Lateral and direc- tional trim <sup>1</sup>	Max. T. O. and land.	Most fwd and most aft.	Opt.	Retr. and ext.	Retr. and ext.	Opt.	Power for level flight	Opt.				Hands-off lateral and directional trim should be demonstrated from 1.4 V <sub>cr</sub> to V <sub>no</sub> or M <sub>no</sub> whichever is the lesser.	
14 (a)	§ 4b.142 (a)	Long. trim in climb	Max. T. O.	Most fwd.	Opt.	Retr. and T. O.	Retr.	Max. cont.	Max. cont.	Opt.				Hands-off long. trim should be demon- strated at a speed not in excess of 1.4 V <sub>cr</sub> .	
(b)	§ 4b.142 (b)	Long. trim in glide	Max. Land.	Most fwd.	Opt.	Retr. and ext.	Ext.	Wind mill- ing	Off	Opt.				Hands-off long. trim should be demon- strated at a speed not in excess of 1.4 V <sub>cr</sub> .	

For footnotes, see p. 220.

(c)	§ 4b.142 (c)	Long. trim in level	Max. T. O. and land.	Most fwd and most aft.	Opt.	Retr. and ext.	Retr. and ext.	Opt.	Power for level flight	Opt.				Hands-off long. trim should be demonstrated from 1.4 V <sub>s1</sub> to V <sub>NO</sub> or M <sub>NO</sub> whichever is lesser with landing gear and flaps retracted and from 1.4 V <sub>s1</sub> to V <sub>LS</sub> with gear extended.	
16	§ 4b.143	Long., directional and lateral trim	Max. T. O.	Most fwd	Opt.	Retr.	Retr.	Max. cont.	Max. cont.	Opt.	Feath.	Closed	Opt.	Hands-off long., directional and lateral trim should be demonstrated during climb at a speed of 1.4 V <sub>s1</sub> .	
16	§ 4b.144	Trim 2 engs. inop.	See note 2	Most fwd	Opt.	Opt.	Retr.	Max. cont.	Max. cont.	Opt.	Feath.	Closed	Opt.	Hands-off long., lateral and directional trim should be demonstrated in rectilinear flight at airspeed used in § 4b.121.	
17	§ 4b.162	Static long. stability landing power-off	Max. land.	Most fwd and most aft	Opt.	Ext.	Ext.	Wind-milling	Power-off	Opt.				Static long. stability should be demonstrated from 1.1 V <sub>s1</sub> to 1.8 V <sub>s1</sub> or to placard speed with airplane trimmed at 1.4 V <sub>s1</sub> .	Elevator control force indicator, and, if required, elevator deflection indicator.
18	§ 4b.163	Static long. stability approach	Max. land.	Max. aft	Opt.	Appr.	Retr.	Power for level flight at 1.4 V <sub>s1</sub>		Appr.				Same as test 17.	Same as item 17.
19	§ 4b.164	Static long. stability climb	Max. T. O.	Most aft	Opt.	Retr.	Retr.	75% max. cont. for reciprocating engines. For turbine engines, see § 4b.164-1(a).		Opt.				Static long. stability should be demonstrated from 85% to 115% of V <sub>trim</sub> when airplane is trimmed at best R/C speed except that trim speed need not be less than 1.4 V <sub>s1</sub> .	Same as item 17.
20 (a)	§ 4b.165 (a)	Static long. stability cruise	Max. T. O.	Most aft	Opt.	Retr.	Retr.	75% max. cont. See § 4b.165-1(a) (1).		Opt.				Determine required static stability over high and low speed ranges. In latter case, test to minimum speed in unstalled flight.	Same as item 17.
(b)	§ 4b.165 (b)	Static long. stability cruise	Max. T. O.	Most aft	Opt.	Retr.	Ext.	75% max. cont. See § 4b.165-1(b) (1).		Opt.				Same as test 20 (a), except highest speed is V <sub>LS</sub> .	
21	§ 4b.166	Dynamic long. stability	OPTIONAL										Damping of any short period oscillations between stalling speed and max. permissible speed should be demonstrated with controls free and in a fixed position.		
22 (a)	§ 4b.167 (a)	Static directional stability	Max. T. O. Max. land	Most aft	Opt.	Retr. Ext.	Retr. Ext.	See § 4b.167		Opt.				Recovery from skid with rudder free should be demonstrated.	
(b)	§ 4b.167 (b)	Static lateral stability	Max. T. O.	Most aft	Opt.	Retr.	Retr. Ext.			Opt.				Tendency of wing to raise in recovery from turn should be demonstrated.	Rudder force indicator.
(c)	§ 4b.167 (c)	Static directional and lateral stability	Max. T. O. Max. land	Most aft	Opt.	Retr. Ext.	Retr. Ext.			Opt.				Proportionality of aileron and rudder deflections and forces during sideslip should be demonstrated.	
23	§ 4b.168	Dynamic directional and lateral stability	Max. T. O. and land	Most aft	Opt.	Retr. and ext.	Retr. and ext.	Opt. Opt.		Opt.				Damping of any short period oscillations should be demonstrated with controls free and fixed at all speeds.	



## Flying Qualities—Continued

Item	CAR ref. No.	Test description	Wt.	O. G.	Altitude	Flap	Land- ing gear	Engines						Test	Special instrumentation
								Operating			Inoperative				
								Prop.	Power	Cowl flap	Prop.	Thrott.	Cowl flap		
24	§4b.160	Stalls symmetrical power straight flight	Land	Fwd	Opt.	Appr.	Ext.	Opt.	On	Opt.	-----	-----	See §4b.160 (c) (1).	Means for continuous recording of angle-of-attack indicator, accelerometer; swivel static and shielded total pressure heads; altimeter; pitch and bank angle indicator; accelerometer; elevator position and force indicator; aileron and rudder position indicator.	
			Land	Fwd		Land									Ext.
			Land	Aft		Appr.	Ext.		On						
			Land	Aft		Land	Ext.		Off						
			Land	Aft		Appr.	Retr.		On						
			Land	Aft		Land	Ext.		On						
			Land	Aft		Land	Retr.		On						
			T. O.	Aft		Retr.	Ext.		Off						
			T. O.	Aft		T. O.	Retr.		Off						
			T. O.	Aft		T. O.	Ext.		On						
			T. O.	Aft		T. O.	Ext.		On						
(b)		Stalls symmetrical power turns	T. O.	Aft	Opt.	Retr.	Retr.	Opt.	Off				Prompt recovery and regain of control with normal piloting skill should be demonstrated in left and right turns up to 80 degrees of bank.		
			T. O.	Aft		Retr.	Retr.		On						
			T. O.	Aft		Land	Ext.		Off						
			Land	Aft		Land	Ext.		On						
25	§4b.161	Stalls asymmetrical power	Max. T. O.	Aft	Opt.	Retr.	Retr.	75% maximum continuous power	Opt.	Opt.	Closed	Opt.	Safe recovery from stall without excessive loss of altitude should be demonstrated. Operating engines may be throttled back during recovery.	Rudder control force indicator if force is critical.	
26	§4b.173	Controllability T. O. and land. in cross wind	Max. T. O. Max. land	Most aft	Opt.	T. O. Ext.	Ext.	Takeoff and power off	Opt.				Takeoffs and landings in cross winds should be demonstrated.	Wind velocity and direction indicator.	
27	§4b.180	Flutter and vibration	Max. T. O. Max. land	Most aft		Retr. Ext.	Retr. Ext.	Cruise power	Opt.				The airplane should be tested from $V_s$ to $V_D$ or to placard speed, gear up and down, flaps up, T. O. approach and landing.		
28	§4b.324	Wing flap interconnection													

REQUIREMENTS SHOULD BE SET UP FOR INDIVIDUAL CASES

\* Additional lateral and directional trim should be demonstrated in other configurations in conjunction with tests in §4b.160.  
 † Weight at which climb is equal to at least 0.01  $V_s$  at 5,000 feet altitude.

### Powerplant Tests

Item	CAR ref. No.	Test description	Wt.	C. G.	Altitude	Flap	Land- ing gear	Engines						Test	Special instrumentation
								Operating			Inoperative				
								Prop.	Power	Cowl flap	Prop.	Thrott.	Cowl flap		
29 (a)	§ 4b.400	Power- plant operation				Opt.	Opt.							Powerplant and propeller operation should be observed for satisfactory operation during the flight test program.	
(b)	§ 4b.400	Propeller operation				Opt.	Opt.								
30	§ 4b.413 (c)	Fuel Pressure				Opt.	Opt.							Ability to regain full fuel pressure on an engine should be demonstrated when engine runs out of fuel from any tank which engine can be fed and when engine is then switched to any full tank.	
31	§ 4b.417	Fuel system hot weather operation	See test	Opt.	See test	Retr.	Retr.	Max. T. O. and max. cont.						Vapor lock or occurrence of any other malfunctioning should be determined when airplane is operated with fuel 110° F. at climb speed which should not exceed that permitting compliance with climb requirement of § 4b.119(a) to the max. operating alt. selected by applicant. Airplane wt. should correspond to operation with full fuel tanks, minimum crew, and ballast to keep airplane within c. g. limits. (This test may be conducted on ground.)	
32	§ 4b.430 <b>D</b>	Fuel pump <b>E</b>	Opt. <b>L</b>	Opt. <b>E</b>	6000 <b>T</b>	Opt. <b>E</b>	Opt. <b>D</b>	Power to maintain level flight	Opt.					Engine operation with fuel at 110° F. using engine-driven fuel pumps alone. This may be a ground test.	
33	§ 4b.452 § 4b.440 (e) § 4b.465 <b>D</b>	Cooling Climb <b>E</b>	Max. T. O. <b>L</b>	Opt. <b>E</b>	See Test <b>T</b>	Opt. <b>E</b>	Opt. <b>D</b>	Max. Cont.	Max. Cont.	FAA hot day cooling position	Feath.	Closed	Opt.	After temperatures are stabilized in level flight, cooling climb should be started at or below the lower of the two altitudes specified in requirement and continued until 5 minutes after peak climb temperatures have been noted or to max. operating alt.	Calibrated temperature indicators for critical head and base, oil inlet, coolant outlet, etc.
34	§ 4b.453 § 4b.440 (a) § 4b.465 <b>D</b>	Cooling Takeoff <b>E</b>	Max. T. O. <b>L</b>	Opt. <b>E</b>	Lowest practicable <b>T</b>	Opt. <b>E</b>	Opt. <b>D</b>	T. O.	T. O.	FAA hot day cooling	Feath.	Closed	Opt.	After temperatures are stabilized in level flight at 75% max. cont. power (all engines operating) using normal cowl flaps and shutter settings, one engine should be feathered and climb started at lowest practicable altitude and continued for the same time interval as takeoff power is used during the determination of the takeoff flight path, the power then being reduced to max. cont. and the climb continued until at least 5 minutes after occurrence of the peak temperature.	Same as item 33.
35	§ 4b.454	Cooling Seaplane operation	Max. T. O.	Opt.		Opt.		Opt.	Sufficient for test air speed	Opt.				Seaplane should be taxied for 10 mins. at 5 m. p. h. above the step speed after temperatures are stabilized.	
36	§ 4b.461	Carburetor air heat rise	Opt.	Opt.	Opt.	Opt.	Opt.	80% max. cont. power	Opt.					Airplane should be stabilized in flight with full cold carburetor. Carburetor preheat should be applied slowly and maintained until carburetor air temperature has stabilized. Tests should be conducted at two different ambient air temperatures unless one test is conducted at temperature of 30° F.	

APPENDIX B

CAM 4b

## Functional and Miscellaneous Tests

Item	CAR ref. No.	Test description	Wt.	O. G.	Altitude	Flap	Land- ing gear	Engines						Test	Special instrumentation
								Operating			Inoperative				
								Prop.	Power	Cowl flap	Prop.	Thrott.	Cowl flap		
37 (a)	§ 4b.334 § 4b.116 (b)	Land. gear re- tracting mecha- nism op- eration and time to retract.	Opt.	Opt.										Landing gear retraction and extension at $1.6 V_{s1}$ and time to retract at $V_s$ speed should be demonstrated. Structure should be substantiated at $0.67 V_c$ .	
(b)	§ 4b.334 (c)	Emer- gency land. gear mecha- nism op- eration.												Satisfactory gear extension by use of emergency system should be demonstrated.	
38	§ 4b.337	Brakes	Max. land.	Most fwd.										Braking deceleration should be demonstrated to be at least 80% of that obtained in § 4b.322 with loss of any single source of brake operating energy supply.	
39	§ 4b.116 (c) § 4b.401 (c)	Propeller time to feather												The time required for the propeller to change from windmilling position to feather position should be determined at $V_s$ speed. Feathering at max. operating altitude should also be demonstrated.	
40 (a)	§ 4b.437 (a) (1)	Fuel jet- tisoning power-off guide.	Max. T. O.	Opt.	Opt.	Retr. or desired approved posi- tion.	Retr. or ext.	Wind- mill- ing.	Off	Opt.				The time required to jettison fuel from tanks and the path of jettisoned fuel as to whether it impinges on any part of the airplane during or after jettisoning should be determined.	
(b)	§ 4b.437 (a) (2)	Fuel jet- tisoning climb.	Max. T. O.	Opt.	Opt.	Retr. or desired approved posi- tion.	Retr. or ext.	Max. cont.	Max. cont.	Opt.	Feath.	Closed	Closed	Same as test 40 (a) during climb with critical eng. inoperative.	
(c)	§ 4b.437 (a) (3)	Fuel jet- tisoning level flight	Max. T. O.	Opt.	Opt.	Retr. or desired ap- proved posi- tion	Retr. or ext.		Opt.					Same as test 40 (a) during level flight.	
41 (a)	§ 4b.467	Exhaust system carbon monoxide	Opt.	Opt.										Carbon monoxide concentration should be determined in personnel compartments during T. O., climb, level flight, approach or landing flight and during heater and cabin supercharger operation.	Carbon monoxide detec- tion indicator.

APPENDIX B

CAM 4b

### Functional and Miscellaneous Tests—Continued

CAM 4b

Item	CAR ref. No.	Test description	Wt.	O. G.	Altitude	Flap	Land- ing gear	Engines						Test	Special instrumentation
								Operating			Inoperative				
								Prop.	Power	Cowl flap	Prop.	Thrott.	Cowl flap		
41 (b)	§ 4b.407 (a) (6)	Visibility.	Opt.	Opt.	-----	-----	-----	-----	-----	-----	-----	-----	-----	The effect of any exhaust gas discharge on pilot visibility at night should be determined.	-----
42	§ 4b.612 (b)	Altimeter calibration	Be- tween max. land and max. T. O.	Opt.	Opt.	Retr.	Retr.  Ext.	Opt.	Opt.	Opt.	-----	-----	-----	If altimeter and airspeed use the same static vent, theoretical calibration from airspeed calibration should be determined and checked by flights at a precise elevation at various speeds.	Instrumentation for accurately determining airplane elevation.
43	§ 4b.640	Pneu- matic boots	Opt.	Opt.	-----	-----	-----	-----	-----	-----	-----	-----	-----	Operation of pneumatic boots should be checked in flight from just above stall the buffeting speed to 1.6 V, and at power off stall.	-----
44	§ 4b.642	Flare operation	Opt.	Opt.	-----	-----	-----	-----	-----	-----	-----	-----	-----	Flight demonstration should be conducted to determine that flare ejection can be accomplished without danger to the airplane or its occupants.	-----

APPENDIX B

- |   |  |   |
|---|--|---|
| 45 (a) § 4b.337 (b) Brake control forces and operation<br>(b) § 4b.337 (c) Parking brake<br>(c) § 4b.380 (g) Noise level<br>(d) § 4b.351 (a) Pilot compartment vision<br>(e) § 4b.351 (b) Windshield wiper and de-icer operation<br>(f) § 4b.363 Cockpit controls | (g) § 4b.376 Cabin pressurization<br>(h) § 4b.384 Cargo and baggage compartment fire precaution<br>(i) § 4b.404 Propeller pitch and speed limitation<br>(j) § 4b.406 Propeller de-icing fluid<br>(k) § 4b.418 Fuel overflow—interconnected tanks<br>(l) § 4b.426 Fuel overflow and syphoning—fuel tank vents | (m) § 4b.449 Propeller feathering—trapped oil supply<br>(n) § 4b.611 Visibility of instrument installation<br>(o) § 4b.630 Instrument lights<br>(p) § 4b.631 Landing lights |
|---|--|---|

## Appendix C

### Suggested Flight Programs for Approval of Changes in Airplane Configuration

The following assumes that an airplane has been type certificated in the transport category, and that a change is made affecting the operating characteristics of the airplane. Suggested general flight programs are given for common type of changes. This is to be used as a guide only since individual cases may require additional or fewer tests than those listed.

#### 1. Tests Affected by Change in Propeller

<i>Items</i>	<i>Test Description</i>
5	Accelerate to $V_1$ cut one engine and continue acceleration to $V_2$
6(b)	Climb—second T. O. segment
6(e)	Climb—en route—all engines
6(g)	Climb—en route—two engines inoperative
6(h)	Climb—approach
6(i)	Climb—landing
10	Minimum control speed
29(b)	Propeller operation
35	Cooling tests
36	Time to feather propeller
45(i)	Propeller pitch and speed limitations

#### 2. Tests Affected by Change in Power Rating

<i>Items</i>	<i>Test Description</i>
2 (a)	Critical altitude—takeoff power
2 (b)	Critical altitude—max. cont. power
5	Accelerate to $V_1$ cut one engine and continue acceleration to $V_2$
6 (b)	Climb—2d T. O. segment
6 (e)	Climb—en route—all engines
6 (g)	Climbs—two engines inoperative
6 (h)	Climb—approach
6 (i)	Climb—landing
8 (f)	Control—sudden changes in power
9 (c)	Control 20° banked turns
10	Minimum control speed
15	Trim 2 engines inoperative
30	Cooling climb—max. cont.
31	Cooling—takeoff

3. Tests Affected by *Addition of a Major Drag Item* (Such as External Tank)

<i>Items</i>	<i>Test Description</i>
3	Stalling speeds
5	Accelerate to $V_1$ cut engine and continue acceleration to $V_2$
6 (a)	Climb—takeoff first segment
6 (e)	Climb—en route—all engines
6 (g)	Climb—en route—2 engines inoperative
6 (h)	Climb—approach
6 (i)	Climb—landing
8 (h)	Control—variation in airspeed
27	Flutter and vibration

4. Tests Affected by *Change in Engines*

<i>Items</i>	<i>Test Description</i>
2 (a)	Critical altitude—T. O. power
2 (b)	Critical altitude—max. cont. power
5	Accelerate to $V_1$ , cut one engine and continue acceleration to $V_2$
6 (b)	Climb, 2d T. O. segment
6 (e)	Climb—en route—all engines
6 (g)	Climb—two engines inoperative
6 (h)	Climb—approach
6 (i)	Climb—landing
8 (f)	Control—sudden changes in power
9 (c)	Control 20° banked turns
10	Minimum control speed
16	Trim 2 engines inoperative
36	Carburator air heat usa

## Appendix D

### A General Order of Testing

<i>Order</i>	<i>Test Description</i>	<i>Item</i>
1.	Airspeed and altimeter calibrations.....	1, 42
2.	Stall speeds.....	3
	Engine calibration.....	2
3.	Minimum control speed.....	10
4.	Engine cooling.....	35
5.	Ground speed calibration, accelerate and stop, accelerate, landing tests, and reverse thrust propeller control.....	1, 4, 5, 7, 12
6.	Climb tests.....	6 (a) through 6 (i)
7.	Fuel system operation and carburetor air heat rise.....	30, 31, 36
8.	Control tests.....	8 (a) through 8 (i), 9 (a) through 9 (d), 11, 26
9.	Stall characteristics.....	24 (a), 24 (b), 25
10.	Trim characteristics and static longitudinal, directional and lateral stability.....	13, 14 (a) through 14 (c), 15, 16, 17, 18, 19, 20 (a), 20 (b), 21, 22 (a) through 22 (c), 23, 28
11.	Flutter and vibration.....	27
12.	Fuel jettisoning.....	40 (a) through 40 (c)
13.	Exhaust system, flare operation, pneumatic boots, landing gear, brakes, propeller feather- ing, and miscellaneous functional.....	41 (a), 41 (b), 44, 43, 37 (a), 37 (b), 38, 39, 45

## Appendix E

### Transport Category (Part 4b) Flight Tests Grouped According to Weight and C. G. Conditions

#### DEFINITIONS

1. Takeoff weight—The maximum takeoff weight at sea level.
2. Landing weight—The maximum landing weight at sea level.
3. Low weight—A specific weight either lower than maximum takeoff or maximum landing.
4. Optional weight—Any weight that the manufacturer elects to use.
5. Appropriate weight—Appropriate to the airplane configuration; i. e., takeoff or landing.
6. Forward c. g.—The maximum forward center of gravity for which approval is desired. If the manufacturer desires to obtain approval for center of gravity limits varying with weight, he may (1) make the test at the nominal weight at the most forward c. g. regardless of weight, or (2) make the critical tests at both the nominal weight and its forward center of gravity limit and at the weight which gives the most forward center of gravity.
7. Aft c. g.—The maximum aft center of gravity for which approval is desired. See 5.
8. Optional c. g.—Any center of gravity that the manufacturer elects to use.

#### WEIGHTS

The test numbers listed below correspond to the item numbers in Appendix B

1. Takeoff weight
  - a. Forward c. g.—4, 5, 13, 14 (a), 14 (c), 15
  - b. Aft c. g.—8 (a), 8 (b), 9 (c), 10, 13, 14 (c), 19, 20 (a), 20 (b), 22 (a) through 22 (c), 23, 24, 25, 26, 27
  - c. Optional c. g.—6 (a) through 6 (f), 35, 40 (a) through 40 (c)
2. Landing weight
  - a. Forward c. g.—3, 7, 8 (c) through 8 (i), 9 (b), 9 (d), 13, 14 (b), 14 (c), 16, 17, 38
  - b. Aft c. g.—8 (a), 8 (b), 9 (a), 13, 14 (c), 17, 18, 22 (a) through 22 (c), 23, 24, 26
  - c. Optional c. g.—6 (h), 6 (i), 8 (c) through 8 (i)
3. Low weight
  - a. Forward c. g.—4, 5, 7<sup>1</sup>
  - b. Aft c. g.—None
  - c. Optional c. g.—6 (a) through 6 (f), 6 (g) (2 wghts.), 6 (h), 6 (i)
4. Optional weight
  - a. Forward c. g.—None
  - b. Aft c. g.—None
  - c. Optional c. g.—1, 2 (a), 2 (b), 21, 27, 28, 29 (a), 29 (b), 30, 32, 36, 37 (a), 37 (b), 39, 41 (a), 41 (b), 42, 43

<sup>1</sup>Most critical c. g. should be used if demonstrations are to be made using reverse thrust.



# Appendix F

## Instrumentation Summary

### 1. Performance Tests

<i>Item</i>	<i>Test Description</i>	<i>Special Instrumentation</i>
1	Airspeed calibration. Ground speed calibration.	Reference airspeed system. May be conducted in conjunction with instrumentation for item 4.
2	Engine calibration.	Humidity indicator.
3	Stalling speeds.	Reference airspeed system, instrument photo-recorder.
4	Accel. to $V_1$ and stop.	Graphically recording vertical and horizontal distance-time instrumentation, wind velocity and direction meteorological instrumentation, humidity indicator.
5	Accel. to $V_2$ .	Same as for item 4.
6 (a) thru 6 (i)	Climbs.	Humidity indicator.
7	Landings.	Same as for item 4.

### 2. Flying Qualities

<i>Item</i>	<i>Test Description</i>	<i>Special Instrumentation</i>
9 (a) and 9 (b)	Control—sudden changes in heading.	Rudder force indicator.
10 17 thru	Minimum control speed. Static longitudinal	Rudder force indicator. Elevator stick force indicator and, if required, elevator deflector indicator.
22 (a), 22 (b), and 22 (c)	Directional and lateral stability.	Rudder control force indicator.
24	Stalls.	Angle-of-attack indicator, accelerometer; swivel static and shielded total pressure head; altimeter; pitch and bank angle indicator; elevator position and force indicator; aileron and rudder position indicator.
25	Stalls—one engine out.	Rudder control force indicator required only when rudder control forces are critical.
26	Control—takeoff and landing in crosswind.	Wind velocity and direction measurement instrumentation.

## 3. Power Plant Tests

<i>Item</i>	<i>Test Description</i>	<i>Special Instrumentation</i>
35	Cooling tests.	Temperature indicators for critical head, base, oil inlet, coolant temperatures.
36	Carburetor air heat rise.	Temperature indicator for carburetor.

## 4. Functional and Miscellaneous Tests

<i>Item</i>	<i>Test Description</i>	<i>Special Instrumentation</i>
41 (a)	Exhaust system—carbon monoxide.	Carbon monoxide detection indicator.
42	Altimeter calibration.	Instrument for precisely determining airplane elevation.

# Appendix G

---

## Special Civil Air Regulations Which Affect Part 4b

## SPECIAL CIVIL AIR REGULATION NO. SR-389B

Effective: January 30, 1959

Adopted: December 24, 1958

### Emergency Exits for Airplanes Carrying Passengers for Hire

Special Civil Air Regulation No. SR-389A, effective September 13, 1957, superseded Special Civil Air Regulation No. SR-389. All of the provisions of SR-389 were retained in SR-389A. However, the latter special regulation as amended on October 17, 1957, contained an addition to the occupant/exit table which permitted the Viscount 700 series airplanes to carry 53 occupants when 7 exits were provided.

Special Civil Air Regulation No. SR-389, effective October 27, 1952, superseded Special Civil Air Regulation No. SR-387. Except for correcting some minor errors with respect to the number of exits authorized by the Civil Aeronautics Administration, there was no difference between the two special regulations.

Special Civil Air Regulation No. SR-387, effective October 27, 1952, was adopted in order to make applicable to the then operating transport airplanes more stringent rules regarding the number of occupants permitted per exit. SR-387 required, among other things, that all large airplanes (more than 12,500 pounds maximum certificated takeoff weight) comply with either section 4b.362 (a), (b), and (c) of Part 4b of the Civil Air Regulations as amended by Amendment 4b-4 effective December 20, 1951, or with the specific requirements set up in SR-387. Subsequently, the provisions of section 4b.362 (a), (b), and (c) of Part 4b were revised by Amendment 4b-5, effective April 9, 1957.

Special Civil Air Regulation No. SR-389A permits the airplanes listed in the occupant/exit table to carry additional occupants if additional exits are provided, except that in no case shall more than 8 additional occupants be carried for any one additional exit. The preamble to Civil Air Regulations Draft Release No. 58-11 stated that the intent of this provision was that no more than 8 additional occupants could be authorized if the most effective exit for emergency evacuation were provided, which, by reference to the rule proposed in the draft release, is seen to be one comparable to a Type I exit as prescribed in section 4b.362. As herein set forth, it is intended that as many as 8 additional occupants may be authorized with the addition of an exit of reasonably high effectiveness and that a lesser number of occupants would be authorized with the addition of a less effective exit. For the purpose of this regulation, it has been established that the addition of an exit, approximating a Type II or IV exit as prescribed in section 4b.362, would possibly permit the addition of 8 occupants. This relaxation over the rule proposed in Draft Release 58-11 was prompted by comments received to the draft release and the fact that a number of airplanes had already received approval to carry 8 additional occupants with the addition of an exit com-

parable to a Type IV based on the Administrator's interpretation of SR-389A. Justification for the relaxation is based upon the current requirements of section 4b.362(c) wherein it may be seen that for the addition of a Type IV exit on each side, an increase of 30 passengers is permitted. While such a ratio is not advocated for airplanes covered by this special regulation because of other factors considered in establishing these values for section 4b.362, permitting 8 occupants to be added for a Type IV exit represents a more reasonable and realistic view than that proposed in Draft Release 58-11. Therefore, it is expressly provided herein that since the effectiveness of the exit varies with the type, size, and location, 8 additional occupants shall be authorized only when an exit comparable to a Type II or a Type IV exit as prescribed in section 4b.362 is provided.

Special Civil Air Regulation No. SR-389A does not contain provisions regarding the required reduction in occupancy when the number of exits is reduced. In order to cover such cases, it is provided herein that upon removal of any exit the maximum number of occupants shall be reduced by at least 8.

The occupant/exit table has been modified by listing the "L-1049 Series" in lieu of the "L-1049," and the "CV-340 and CV-440" in lieu of the "CV-340."

Interested persons have been afforded an opportunity to participate in the making of this regulation (23 F.R. 3275), and due consideration has been given to all relevant matter presented.

In consideration of the foregoing, the Civil Aeronautics Board hereby makes and promulgates the following Special Civil Air Regulation, effective January 30, 1959.

1. Contrary provisions of the Civil Air Regulations notwithstanding, no large airplane (more than 12,500 pounds maximum certificated take-off weight) while carrying passengers for hire shall be operated with occupants in excess of the number permitted by applying the provisions of section 4b.362 (a), (b), and (c) of Part 4b of the Civil Air Regulations as amended by Amendment 4b-5, effective April 9, 1957, except that airplane types listed in the following table may be operated with the listed maximum number of occupants (including all crew members) and the listed corresponding number of exits (including emergency exits and doors) heretofore approved by the Administrator for emergency egress of passengers.

2. Additional occupants above the values listed in the table may be carried if additional exits are provided, except that in no case shall more than 8 additional occupants be carried for any one additional exit. For the addition of exits comparable to at least a Type II or Type IV exit as prescribed in section 4b.362, a maximum of 8 additional occupants may be authorized and for exits not comparable to at least a Type II or Type IV exit, the Administrator after consideration, among other factors, of the type, size, and location of the exit, may authorize a lesser number of additional occupants.

3. For airplanes which have a ratio (as computed from the table in this special regulation) of maximum number of occupants to number of exits greater than 14:1 and for airplanes which do not have installed at least one full-size door-type exit in the side of the fuselage in the

rearward portion of the cabin, the first additional exit approved by the Administrator for increased occupancy shall be a floor-level exit not less than 24 inches wide by 48 inches high located in the side of the fuselage in the rearward portion of the cabin. In no case shall an occupancy greater than 115 be allowed unless there is such an exit on each side of the fuselage.

4. The maximum number of occupants authorized (listed in the table) shall be reduced where the number of approved exits is less than that shown in the table. The reduction in the maximum number of occupants for each exit eliminated shall be determined by the Administrator taking due account of the effectiveness of the remaining exits for emergency evacuation, except that the maximum number of occupants shall be reduced by at least 8 for each eliminated exit. In no case, when exits are deleted, shall the resulting ratio of occupants to exits be greater than 14:1, and there shall be at least one exit on each side of the fuselage irrespective of the number of occupants.

Airplane type	Maximum number of occupants including all crew members	Corresponding number of exits authorized for passenger use
B-307.....	61	4
B-377.....	96	9
C-46.....	67	4
CV-240.....	53	6
CV-340 and CV-440.....	53	6
DC-3.....	35	4
DC-3 (Super).....	39	5
DC-4.....	86	5
DC-6.....	87	7
DC-6B*.....	112	11
L-18.....	17	3
L-049, L-649, L-749.....	87	7
L-1049 series.....	96	9
M-202.....	53	6
M-404.....	53	7
Viscount 700 series.....	53	7

\*The DC-6A, if converted to a passenger transport configuration, will be governed by the maximum number applicable to the DC-6B.

This regulation supersedes Special Civil Air Regulation No. SR-389A as amended by Amendment No. 1 and shall remain effective until superseded or rescinded by the Board or the Administrator of the Federal Aviation Agency, as appropriate.

AMENDMENT I TO SPECIAL CIVIL AIR REGULATION NO. SR-389B

Effective: September 11, 1959

Adopted: September 11, 1959

Emergency Exits for Airplanes Carrying Passengers for Hire

Special Civil Air Regulation No. SR-389B, adopted by the Civil Aeronautics Board on December 24, 1958, and effective January 30, 1959, specified in part that no large airplane while carrying passengers for hire shall be operated with occupants in excess of the number permitted by applying the provisions of section 4b.362 (a), (b), and (c) of Part 4b of the Civil Air Regulations as amended by Amendment 4b-5 effective April 9, 1957, except for those airplanes listed in the table in SR-389B. Special Civil Air Regulations SR-389A, which preceded SR-389B, contained a similar provision but referred to Amendment 4b-4 effective December 20, 1951. The effect of SR-389B was to apply the current Part 4b exit requirements referenced in SR-389A.

A review of the history of the development of SR-389B indicates that such retroactive application of current Part 4b requirements was included inadvertently and that it would impose an unnecessary burden on the operators of certain airplanes. SR-389B is therefore being amended to eliminate this retroactive provision.

Since this amendment imposes no additional burden on any person, notice and public procedure hereon are unnecessary, and the amendment is made effective immediately.

In consideration of the foregoing, Paragraph 1 of Special Civil Air Regulation No. SR-389B is hereby amended to read as follows, effective September 11, 1959.

1. Contrary provisions of the Civil Air Regulations notwithstanding, no large airplane (more than 12,500 pounds maximum certificated take-off weight) type certificated under Civil Air Regulations effective prior to April 9, 1957, while carrying passengers for hire, shall be operated with occupants in excess of the number permitted by applying the provisions of section 4b.362 (a), (b), and (c) of Part 4b of Civil Air Regulations as amended by Amendment 4b-4 effective December 20, 1951, except that airplane types listed in the following table may be operated with the listed maximum number of occupants (including all crew members) and the listed corresponding number of exits (including emergency exits and doors) heretofore approved by the Administrator for the emergency egress of passengers.

SPECIAL CIVIL AIR REGULATION NO. SR-392C

Effective: Feb. 3, 1962  
Adopted: Jan. 30, 1962  
Published: Feb. 3, 1962  
(27 F.R. 1008)

Facilitation of Experiments With Exterior Lighting Systems

Special Civil Air Regulation No. SR-392B, adopted on February 25, 1957, permits experimentation with exterior lighting systems, which do not comply with the standards prescribed in the Civil Air Regulations, on aircraft with standard airworthiness certificates. Several conditions are imposed to insure that the number of aircraft engaged in the experiments is reasonably limited; that the experimental exterior lights are in fact installed for bonafide experimentation; and that the results of such experimentation become generally available. This special regulation expires on February 25, 1962.

In a notice of proposed rule making contained in Draft Release No. 61-27 and published in the Federal Register, December 23, 1961 (26 F.R. 12294), the Agency gave notice that it has under consideration the termination of SR-392B and requested comments from interested persons concerning this matter. In response to such request, the Agency has received numerous reports, arguments and other evidence. However, the volume of the comments received is such that there is not sufficient time remaining to review and evaluate such comments prior to the termination of SR-392B. Therefore, in order to afford the Agency the opportunity to fully consider all the relevant matter presented and to take whatever additional rule making action that may be indicated, it is necessary to extend the termination date of SR-392B to June 25, 1962.

Since this regulation continues in effect the provisions of the previous regulation and imposes no additional burden upon any person, compliance with the notice and public procedure provisions of the Administrative Procedure Act is unnecessary and good cause exists for making this regulation effective on less than 30 days' notice.

In consideration of the foregoing, the following Special Civil Air Regulation is adopted to become effective on February 3, 1962:

Contrary provisions of the Civil Air Regulations notwithstanding, experimental exterior lighting equipment which does not comply with the relevant specifications contained in the Civil Air Regulations may, subject to the approval of the Administrator, be installed and used on aircraft for the purpose of experimentation intended to improve exterior lighting for a period not to exceed 6 months: *Provided*, That

(1) The Administrator may grant approval for additional periods if he finds that the experiments can be reasonably expected to contribute to improvements in exterior lighting;



(2) Not more than 15 aircraft possessing a U.S. certificate of airworthiness may have installed at any one time experimental exterior lighting equipment of one basic type;

(3) The Administrator shall prescribe such conditions and limitations as may be necessary to insure safety and avoid confusion in air navigation;

(4) The person engaged in the operation of the aircraft shall disclose publicly the deviations of the exterior lighting from the relevant specifications contained in the Civil Air Regulations at times and in a manner prescribed by the Administrator; and

(5) Upon application for approval to conduct experimentation with exterior lighting, the applicant shall advise the Administrator of the specific purpose of the experiments to be conducted; and, at the conclusion of the approved period of experimentation, he shall advise the Administrator of the detailed results thereof.

This regulation supersedes Special Civil Air Regulation No. SR-392B and shall terminate June 25, 1962, unless sooner superseded or rescinded.

## SPECIAL CIVIL AIR REGULATION NO. SR-392D

Effective: June 25, 1962  
Adopted: June 22, 1962  
Published: June 26, 1962  
(27 F.R. 5979)

### Display of Experimental Exterior Lighting Systems Approved for Use on Aircraft

Special Civil Air Regulation No. SR-392B, adopted on February 25, 1957, and superseded by SR-392C on February 3, 1962, permitted experimentation with exterior lighting systems that did not comply with the standards prescribed in the Civil Air Regulations on aircraft with standard airworthiness certificates. Several conditions were imposed to insure that the number of aircraft engaged in the experiments was reasonably limited; that the experimental exterior lights were in fact installed for bona fide experimentation; and that the results of such experimentation became generally available.

In a notice of proposed rule making contained in Draft Release No. 61-27 and published in the Federal Register, December 23, 1961 (26 F.R. 12294), the Agency gave notice that it had under consideration the termination of SR-392B, which was then in effect, and requested comments from interested persons. However, the nature of the comments received was such that there was not sufficient time remaining, before the February 25, 1962, termination date specified in SR-392B, for their proper review and evaluation. To provide the time needed, the Agency adopted SR-392C which superseded SR-392B without revision other than extension of the termination date from February 25, 1962, to June 25, 1962.

On April 3, 1962, the Agency convened a public conference (previously announced by a notice of conference dated February 12, 1962) to give persons interested in SR-392C an opportunity to supplement their written comments with oral presentations, to make additional evidence available, and to participate in direct discussions with government-industry technical people in the aircraft lighting field.

From a study of all comments made on the issue, those who support the need for an extension of SR-392C contend essentially as follows: (1) Experimental lighting systems now operating under SR-392C are more effective than the system prescribed in the Civil Air Regulations; (2) much money and time has been invested in the experiments, which would be wasted if SR-392C were terminated; (3) extension would continue grass-roots cooperation between experienced FAA inspectors and inventors, and stimulate inventive initiatives; (4) unrestrictive field testing would insure reliability of new lighting equipment by exposing it to actual service conditions; (5) a new lighting concept cannot attract financing, or interest manufacturing management, unless its sales potential is established by flight demonstrations to prospective customers; and (6) there is no satisfactory alternative to extension of SR-392C.

After more than 10 years of experimentation under the provisions of SR-392C and predecessor special regulations, the evidence supporting the contention that various experimental lighting systems surpass the standard system now prescribed in the Civil Air Regulations remains inconclusive. For the most part, reports submitted by experimenters contain subjective evaluations

of proposed systems without the use of experimental controls to insure a valid basis for comparison. Tests and studies conducted by the Navy Department and by the Agency's National Aviation Facilities Experimental Center have not corroborated the advantages claimed by private experimenters for their respective systems.

The experiments were no doubt expensive and time-consuming, but the persons who undertook them did so voluntarily and with no assurance of success. In any case, the costs incurred in such experiments do not justify the indefinitely prolonged display of experimental lighting systems, since these systems necessarily introduce some degree of ambiguity and confusion in night operations.

Termination of SR-392C would not prevent further lighting experimentation since such experiments could still be performed under the terms of an experimental airworthiness certificate. There appears to be no reason why cooperation between FAA inspectors and inventors would necessarily diminish if further lighting experiments were conducted only on that basis.

The point that unrestricted field testing insures reliability of experimental lighting equipment is largely irrelevant since the objective of SR-392C was to facilitate experiments with new lighting concepts rather than to achieve component reliability. Component technology is not in question; and, in any case, there is no evidence that unusual problems exist. Further, reliability can be attained to a large extent by laboratory tests in a simulated environment, a practice which has worked satisfactorily in the past.

It may be true that the privileges granted by SR-392C (as opposed to the generally more restrictive terms of experimental airworthiness certificates) make it easier to finance new lighting concepts, but similar privileges are not granted to those who experiment with aircraft in other ways. This preference for one class of experimenters over all other classes has not been justified in terms of safety improvements achieved to date.

Reasonable alternatives to SR-392C are, in fact, open to experimenters. Experiments may be conducted under the terms of an experimental airworthiness certificate; and the Agency's well-equipped experimental facilities, with trained personnel, are now available for cooperative evaluation of new lighting concepts developed by inventors.

For these reasons, the Agency concludes that the arguments offered in support of an extension of SR-392C are not persuasive; and SR-392C will not be continued in effect beyond June 25, 1962. However, the Agency believes that a reasonable transition period of not less than one year should be established. This would permit 6 months for completion of experiments begun before June 25, 1962, the maximum period of experimentation permitted under SR-392C without special permission, and would allow not less than an additional 6 months for airplane modifications that may be necessitated by the termination of experimentation hereunder.

The various experiments which were conducted under the provisions of SR-392C and predecessor special regulations, although inconclusive, have, nevertheless, helped to crystallize the Agency's position on the need for revisions of the currently effective exterior lighting regulations. Therefore, a proposed rule concerning these requirements is under study by the Agency. If rule making action is initiated as a result of this study, it may ultimately affect some of the details of the lighting systems now required to be installed on aircraft. Moreover, if such rule making action is initiated it may not be

completed before December 25, 1962. In such case, a requirement to accomplish the necessary modifications within one year after the termination of SR-392C, i.e., by June 25, 1963, may not provide the operator with a period of 6 months in which to accomplish the modifications, if any, required by the regulation.

In order to permit an adequate transition period for the accomplishment of any necessary modifications, this regulation permits the current experimental lighting systems to be used until June 25, 1963, or 6 months after completion of the proposed rule making action in regard to exterior lighting systems, whichever date is later. If, however, the Agency finds at the conclusion of its studies that rule making action will not be adopted an appropriate notice thereof will be issued and published in the Federal Register. In such case this regulation also permits the experimental lighting systems to be used until June 25, 1963, or 6 months after such notice is published in the Federal Register, whichever date is later.

In consideration of the foregoing, the following Special Civil Air Regulation is adopted to become effective on June 25, 1962:

Contrary provisions of the Civil Air Regulations notwithstanding, experimental exterior lighting systems which do not comply with the Civil Air Regulations, and which were installed for the purposes of experimentation on aircraft with standard airworthiness certificates under the provisions of SR-392B or SR-392C, may be displayed until:

- (1) 6 months after the date of publication in the Federal Register of either
  - (i) revised standards adopted by the Agency for exterior lighting systems, or
  - (ii) a notice that rule making action to revise such standards will not be adopted by the Agency; or
- (2) June 25, 1963, if later than that specified in paragraph (1).

This Special Civil Air Regulation shall remain in effect until superseded or rescinded.

SPECIAL CIVIL AIR REGULATION NO. SR-406C

Effective: July 1, 1956

Adopted: June 28, 1956

Application of Transport Category Requirements to C-46-Type Airplanes

On June 30, 1954, the Civil Aeronautics Board adopted Special Civil Air Regulation No. SR-406, effective July 1, 1954, which provided for the modification and operation of C-46 type airplanes in passenger service. On June 7, 1955, the Board adopted Special Civil Air Regulation No. SR-406A, effective June 7, 1955, which added certain substantive and clarifying amendments to SR-406. On March 30, 1956, the Board adopted Special Civil Air Regulation No. SR-406B, effective April 1, 1956, which extended the date for modification of C-46 airplanes in passenger service from April 1, 1956, to July 1, 1956. The preamble material of these three Special Civil Air Regulations is incorporated herein by reference.

SR-406B provided only temporary relief from those provisions of Special Civil Air Regulation No. SR-406A which prevented the use of C-46 airplanes in passenger operations under Part 42 of the Civil Air Regulations on and after April 1, 1956, unless recertificated in accordance with the regulation. In SR-406B, the Board indicated that subject to persuasive reasons for failing, type certification had to be accomplished before July 1, 1956, and that, within the effective period of the regulation, the Board would determine a later end effective date by which recertification of these airplanes in the transport category must be completed. It was expressly stated that the later end effective date for recertification would depend on a bona fide showing of meeting the type certification requirements.

Since the adoption of Special Civil Air Regulation No. SR-406B, two type certificates have been issued under its provisions and one application for a type certificate has been received although complete data have not been submitted to the Civil Aeronautics Administration as of the date of adoption of this regulation, SR-406C.

In adopting SR-406B, the Board anticipated obtaining a schedule of modification of C-46 airplanes from the applicants for type certification. In its attempt to obtain this information, not only has the Board not received such a schedule, but has been advised that only a comparatively few operators have actual contractual agreements with holders of type certificates to accomplish the required modification.

The Board has previously stated that a final compliance date for modification would depend on a bona fide showing that the aircraft certification requirements will be met in the reasonably near future. However, in the absence of such a showing by more than a few operators, the Board must establish an end compliance date without the benefit of any complete and detailed modification schedules. In the only formal request for an extension of the effective date of these regulations which the Board has received, it is indicated that required modifications are

expected to be completed by January 1, 1957. No other information available to the Board indicates that this is not a reasonable end effective date; therefore, January 1, 1957, is hereby established as the date when recertification is required.

Since October 1, 1955, the Administrator has been authorized to permit the continued operation of C-46 aircraft in passenger service on a showing by operators that "genuine and diligent efforts" have been made to accomplish the required modifications. In the light of the fact that there now exist at least two persons possessing type certificates on the basis of which such modifications may be made, there no longer appears to be any reason for not requiring the showing of a firm contract between the operator and the holder of such a type certificate indicating that the required modifications will be completed prior to January 1, 1957, prior to such operations. Accordingly, this Special Civil Air Regulation contains a requirement that before the Administrator is authorized to continue to permit operation of C-46 airplanes in passenger service, between July 1, 1956, and January 1, 1957, there must be a showing by the operator that he has a firm contract with the holder of a type certificate to complete modifications prior to January 1, 1957, except that the Administrator may authorize during the period July 1, 1956, through July 15, 1956, such operations without a showing of such firm contract where the Administrator has previously permitted such operations based on genuine and diligent efforts to complete the required modifications. In other words, the Administrator may authorize continued operations of C-46 airplanes in passenger service from July 1, 1956, to July 16, 1956, where he has previously given such authority. However, on and after July 16, 1956, the Administrator may authorize such continued operations only upon a showing by the operator that he has a firm contract with the holder of a type certificate to complete modifications prior to January 1, 1957.

As stated hereinbefore, all the preamble material pertinent to the application of transport category requirements to C-46 type airplanes appearing in SR-406, SR-406A, and SR-406B is incorporated herein by reference. However, in order to obviate any possible confusion as to which specific regulations are presently applicable to accomplish the recertification of the C-46 in passenger service, all such regulations are included in this Special Civil Air Regulation.

Since this regulation continues in effect the same rules as are presently applicable to C-46 type airplanes, with the exception of the compliance date listed herein, without diminution in safety standards, and since it would be in the public interest to prescribe rules to become effective on July 1, 1956, to permit the continuation of operation of C-46 type airplanes in passenger service, the Board finds that omission of notice and public procedure is not contrary to public interest and that good cause exists for making this regulation effective on less than 30 days' notice.

In consideration of the foregoing, the Civil Aeronautics Board hereby makes and promulgates the following Special Civil Air Regulation, effective July 1, 1956:

1. Contrary provisions of the Civil Air Regulations notwithstanding (in particular the provisions of section 42.15(b) of Part 42), C-46 airplanes may be used in passenger operations conducted under Part 42 of the Civil Air Regulations. Such airplanes shall be operated in accord-

ance with section 42.15(a) of Part 42 and the provisions of this special regulation.

2. C-46 type airplanes, when used in passenger operations in accordance with paragraph 4 of this regulation, shall not be operated at weights exceeding those which are demonstrated to the Administrator will allow compliance with the performance requirements of Part 4b, except that in determining the maximum take-off weight, such weight shall be limited only to a value at which the airplane has a rate of climb equal to  $0.035 V_{st}^2$  in the take-off configuration at sea level with the landing gear retracted but with the propeller of the inoperative engine feathered rather than windmilling.

3. Provisionally, pending a determination by the Administrator of the weights at which C-46 airplanes will meet the standards prescribed by paragraph 2 of this regulation, the maximum take-off weight of such airplanes, when used in the manner herein referred to, shall not exceed 44,300 pounds: *Provided*, That in the case of C-46 airplanes equipped with Hamilton Standard propellers with blades Model Number 6419A-9 or approved equivalent which have been clipped in accordance with specifications approved by the Administrator, such provisional maximum weight shall be increased by 1,000 pounds until such time as the Administrator shall have determined by suitable tests another value to correspond to the additional efficiency obtainable by the use of such propellers, and thereafter by such other value.

4. The Administrator of Civil Aeronautics may authorize continued operation of C-46 airplanes in passenger service in accordance with paragraphs 2 and 3 of this regulation until January 1, 1957, if he finds that the applicant for such authorization has a bona fide, firm contract with the holder of a type certificate indicating that the required modifications will be completed prior to January 1, 1957, except that the Administrator may authorize during the period July 1, 1956, through July 15, 1956, such continued operation without a showing of such firm contract where the Administrator has previously permitted such operations based on genuine and diligent efforts to complete the required modifications. Such type certificate shall indicate that it meets the transport category requirements of Part 4b of the Civil Air Regulations in effect on July 20, 1950, with the exceptions authorized in SR-406A.

5. On and after July 1, 1956, (except as provided in paragraph 4) C-46 airplanes in passenger service shall comply with the provisions of Part 4b as in effect on July 20, 1950, except as otherwise provided hereinafter:

a. The provisions of sections 4b.0 through 4b.19 of Part 4b, effective May 18, 1954, shall be complied with.

b. The provisions of sections 4b.100 through 4b.190 need not be complied with.

c. The birdproof windshield requirements of section 4b.352 need not be complied with.

d. The provision of sections 4b.480 through 4b.490 effective May 16, 1953, shall be complied with in lieu of sections 4b.480 through 4b.489 effective July 20, 1950, with the exception of subparagraph 4b.484(a)(1) which shall be applicable as effective July 20, 1950, and paragraph 4b.487(e) which has no counterpart in the 1950 regulations.

6. On and after January 1, 1957, C-46 airplanes in passenger service shall be recertificated in the transport category in accordance with paragraph 5 of this regulation, and shall comply with the provisions of sections 4b.100 through 4b.190 with the following exception: In determining the take-off path in accordance with section 4b.116 and the one-engine-inoperative climb in accordance with section 4b.120 (a) and (b), the propeller of the inoperative engine may be assumed to be feathered if there is installed either an approved means for automatically indicating when the particular engine has failed or an approved means for automatically feathering the propeller of the inoperative engine.

7. In applying the provisions of paragraphs 5 and 6 of this regulation, where literal compliance with the requirements of sections 4b.130 through 4b.190 of Subpart B and Subparts C, D, E, and F of Part 4b is extremely difficult to accomplish, and where the Administrator finds that service experience with the C-46 type airplane so justifies, the Administrator may authorize deviations from specific details of these requirements, taking into account the effect of design changes.

8. On or after January 1, 1957, C-46 airplanes in passenger service shall be operated in accordance with the performance operating limitations applicable to transport category airplanes.

9. C-46 airplanes which comply with the provisions of paragraphs 5 and 6 of this regulation may be used in passenger operations conducted under the provisions of Parts 40 and 41 provided they are operated in accordance with paragraph 8.

10. This Special Civil Air Regulation supersedes Special Civil Air Regulation SR-406B.



SPECIAL CIVIL AIR REGULATION NO. SR-407

Effective: September 10, 1954  
Adopted: August 6, 1954

Basis for Approval of Modification of Airplane Types Douglas DC-3 and Lockheed L-18

On October 7, 1953, the Civil Aeronautics Board adopted Special Civil Air Regulation SR-398, effective November 11, 1953, (18 F.R. 6448) which provided a basis for approval of modifications of DC-3 and L-18 airplanes, but limited the scope of that regulation to increases in engine takeoff power limitation up to 1,350 horsepower per engine, to installation of engines of not more than 1,830 cubic inches displacement, and to the establishment of new maximum certificated weights not in excess of 26,900 pounds for the DC-3 and 19,500 pounds for the L-18. This regulation expands the scope of SR-398 to cover approval of additional modifications and maximum certificated weights for DC-3 and L-18 airplanes. In order to have all the regulations applicable to modifications and weight increases of the DC-3 and L-18 appear in one document, this regulation embodies herein the provisions of SR-398 and the additional regulations which are made applicable to these airplanes. SR-398 is thus superseded by this regulation.

The Douglas DC-3 and the Lockheed L-18 airplane types were originally designed and certificated on the basis of airworthiness standards in effect prior to 1940. These were contained in Bulletin 7-A promulgated by the former Bureau of Air Commerce and in the initial Part 04 of the Civil Air Regulations which was basically a recodification of Bulletin 7-A. Subsequently the Civil Aeronautics Board promulgated and kept up to date newer airworthiness requirements contained in Parts 3, 4a, and 4b of the Civil Air Regulations, the latter two parts containing rules for transport category airplanes. The DC-3 and L-18 are the only large airplane types now in general use in the United States which retain the old standards as a basis for their certification.

For a number of years after the initial certification of these two airplane types relatively few important design changes were introduced, and the airplane specifications regarding maximum certificated weights remained practically unchanged. More recently, however, several operators have made significant design changes in DC-3 and L-18 airplanes and it has become apparent that with the continued use of these airplanes, more operators are considering design changes, such as the installation of higher powered engines and increases in maximum certificated weights. Although the basis for certification of these airplanes remains unchanged, the Administrator of Civil Aeronautics in some instances has made changes to the pertinent aircraft specifications by applying certain provisions of Part 4a of the Civil Air Regulations. The Board does not consider Bulletin 7-A and the early versions of Part 04 adequate regulatory bases upon which further modifications to these airplane types can be approved by the Administrator.

The provisions of this Special Civil Air Regulation provide the basis for approval by the Administrator of future modifications of individual DC-3 and L-18 airplanes. The provisions in section 1 of SR-398 permit-

ting the Administrator to waive the requirements of the regulation when it was shown that a particular airplane was in the process of modification at the time that regulation became effective, has been omitted from this regulation because SR-398 has been in effect for sufficient time to eliminate the need for waiver authority by the Administrator.

This regulation continues the general provisions of SR-398 which required that modifications of DC-3 and L-18 airplanes be accomplished in accordance with the provisions of either Part 4a or Part 4b of the Civil Air Regulations applicable to the modification being made, and which were in effect on September 1, 1953, unless the applicant elects to make the modification in accordance with Part 4b as in effect on the date of modification. This regulation requires, also, that in electing to perform a modification under either Part 4a or Part 4b, each specific modification must be accomplished in accordance with all of the provisions of either Part 4a or Part 4b related to the particular modification. It does not permit selection of certain provisions of Part 4a and other provisions of Part 4b. For example, if it were desired to make a modification of the landing gear, it could be made under either Part 4a or Part 4b, but not partially under Part 4a and partially under Part 4b. This also applies when the applicant elects to make a modification in accordance with the provisions of Part 4b in effect on the date of modification in lieu of Part 4a or Part 4b as in effect on September 1, 1953.

In addition to the general provisions for modification, this regulation contains the specific requirements of SR-398 with respect to approval of increases in takeoff power limitation and the installation of new type engines in DC-3 and L-18 airplanes and provides some additional requirements. The intent of these specific requirements is to ensure that such changes will not result in a decrease in safety. This is in general consistent with the policy followed by the Administrator in approving changes made prior to the adoption of SR-398.

In the case of an increase in the takeoff power limitation beyond 1,200 horsepower per engine, but not to exceed 1,350 horsepower per engine, this regulation continues the provisions of SR-398 which required that the increase in power shall not adversely affect the flight characteristics of the airplane. The intent of this provision is to permit increases in takeoff power only if the applicant can show that the use of the increased power does not result in deterioration of the flight characteristics of the airplane when compared to its previous characteristics. It is believed, however, that increases in takeoff power limitation above 1,350 horsepower per engine may result in changes in the engine installation and the airplane's flight characteristics to such an extent that the basis for approval of increases in horsepower provided in SR-398 is no longer appropriate. Since Part 4b represents the most recent design practices, this regulation provides that the takeoff power limitation may be increased beyond 1,350 horsepower if compliance is shown with Part 4b at the increased power with respect to the engine installation provisions, the flight characteristics, and the ground handling requirements.

This regulation contains the provisions of SR-398 which established either Part 4a or Part 4b as the basis for approving the installation of engines not exceeding 1,830 cubic inches displacement which necessitate major modification or redesign, on the condition that there is no de-

crease in engine fire prevention and protection when compared to the prior engine installation. Since the use of engines with more than 1,830 cubic inches displacement will necessitate extensive modification of the entire engine installation, it appears necessary that such an installation be accomplished in accordance with the most recent airworthiness provisions of the regulations. This regulation, therefore, requires that the installation of these larger engines be accomplished in accordance with the requirements of Part 4b of the Civil Air Regulations.

This regulation also continues the provisions of SR-398 which permitted establishment of new maximum certificated weights not to exceed 26,900 pounds for the DC-3 and 19,500 pounds for the L-18. Where such new maximum weights are desired, the airworthiness certificates may be amended and the maximum weights established in accordance with the transport category performance requirements of either Part 4a or Part 4b, subject to the structural limitations of the airplane. With respect to maximum weights in excess of 26,900 pounds for the DC-3 and 19,500 pounds for the L-18, however, it is considered that such increases in weight may seriously affect not only the structural limitations, but also the flight and ground handling characteristics of the airplane. This regulation requires that weights in excess of 26,900 pounds for the DC-3 and 19,500 pounds for the L-18 shall be established in accordance with the performance, structural, flight characteristics, and ground handling requirements of Part 4b.

It should be noted that in certain cases, showing of compliance is required on the basis of Part 4b of the Civil Air Regulations. In some instances, literal compliance with the provisions of Part 4b may be extremely difficult to accomplish and would not contribute materially to the objective sought. In such cases this regulation provides that the Administrator may take into account the experience gained with the DC-3 and L-18 airplanes. Where such experience justifies it, he is authorized to accept in lieu of the literal provisions of Part 4b such measures of compliance as he finds will effectively accomplish the basic objectives.

SR-398 also required, as a basis for approval of new maximum certificated weights, that the applicant provide flight manual material containing information which will permit the application of the transport category performance operating limitations in the operation of the airplane. This Special Civil Air Regulation continues this requirement. In view of the fact that an applicant for new maximum certificated weights has such weights established in accordance with the transport category performance requirements of either Part 4a or Part 4b, this regulation also provides that an airplane having such newly established weights shall be considered a transport category airplane in applying the operating rules of the Civil Air Regulations. As a result, therefore, such airplanes when used in air carrier passenger service must be operated in accordance with the transport category performance operating limitations, but when used in other types of services the transport category performance operating limitations are not applicable as at present. Consideration is being given, however, to the problem of making them applicable to all types of operations conducted in transport category airplanes. If such rules are established, then all DC-3 and L-18 airplanes, having

certificated weights increased in accordance with SR-398 or this regulation, will have to comply with these rules also. In the meantime, it is recommended that operators, whose airplanes are approved for increased weights by reason of SR-398 or by this regulation, make use of this information to aid in assuring safety in their operations.

Interested persons have been afforded an opportunity to participate in the making of this regulation, and due consideration has been given to all relevant matter presented.

In consideration of the foregoing, the Civil Aeronautics Board hereby makes and promulgates the following Special Civil Air Regulation effective September 10, 1954:

1. *Applicability.* Contrary provisions of the Civil Air Regulations regarding certification notwithstanding, this regulation shall provide the basis for approval by the Administrator of modifications of individual Douglas DC-3 and Lockheed L-18 airplanes subsequent to the effective date of this regulation.

2. *General Modifications.* Except as modified in sections 3 and 4 of this regulation, an applicant for approval of modifications to a DC-3 or L-18 airplane which result in changes in design or in changes to approved limitations shall show that the modifications were accomplished in accordance with the rules of either Part 4a or Part 4b in effect on September 1, 1953, which are applicable to the modification being made: *Provided*, That an applicant may elect to accomplish a modification in accordance with the rules of Part 4b in effect on the date of application for the modification in lieu of Part 4a or Part 4b as in effect on September 1, 1953: *And provided further*, That each specific modification must be accomplished in accordance with all of the provisions contained in the elected rules relating to the particular modification.

3. *Specific conditions for approval.* An applicant for any approval of the following specific changes shall comply with section 2 of this regulation as modified by the applicable provisions of this section:

(a) *Increase in takeoff power limitation—1,200 to 1,350 horsepower.* The engine take-off power limitation for the airplane may be increased to more than 1,200 horsepower but not to more than 1,350 horsepower per engine if the increase in power does not adversely affect the flight characteristics of the airplane.

(b) *Increase in takeoff power limitation to more than 1,350 horsepower.* The engine takeoff power limitation for the airplane may be increased to more than 1,350 horsepower per engine if compliance is shown with the flight characteristics and ground handling requirements of Part 4b.

(c) *Installation of engines of not more than 1,830 cubic inches displacement and not having a certificated take-off rating of more than 1,350 horsepower.* Engines of not more than 1,830 cubic inches displacement and not having a certificated takeoff rating of more than 1,350 horsepower which necessitate a major modification or redesign of the engine installation may be installed, if the engine fire prevention and fire protection are equivalent to that on the prior engine installation.

<sup>1</sup> It is not intended to waive compliance with such airworthiness requirements as are included in the operating parts of the Civil Air Regulations for specific types of operation.

(d) *Installation of engines of more than 1,830 cubic inches displacement or having certificated takeoff rating of more than 1,350 horsepower.* Engines of more than 1,830 cubic inches displacement or having certificated takeoff rating of more than 1,350 horsepower may be installed if compliance is shown with the engine installation requirements of Part 4b: *Provided*, That where literal compliance with the engine installation requirements of Part 4b is extremely difficult to accomplish and would not contribute materially to the objective sought, and the Administrator finds that the experience with the DC-3 or L-18 airplanes justifies it, he is authorized to accept such measures of compliance as he finds will effectively accomplish the basic objective.

4. *Establishment of new maximum certificated weights.* An applicant for approval of new maximum certificated weights shall apply for an amendment of the airworthiness certificate of the airplane and shall show that the weights sought have been established, and the appropriate manual material obtained, as provided in this section. (Note: Transport category performance requirements result in the establishment of maximum certificated weights for various altitudes.)

(a) *Weights—25,200 to 26,900 for the DC-3 and 18,500 to 19,500 for the L-18.* New maximum certificated weights of more than 25,200 but not more than 26,900 pounds for DC-3 and more than 18,500 but not more than 19,500 pounds for L-18 airplanes may be established in accordance with the transport category performance requirements of either Part 4a or Part 4b, if the airplane at the new maximum weights can meet the structural requirements of the elected part.

(b) *Weights of more than 26,900 for the DC-3 and 19,500 for the L-18.* New maximum certificated weights of more than 26,900 pounds for DC-3 and 19,500 pounds for L-18 airplanes shall be established in accordance with the structural, performance, flight characteristics, and ground handling requirements of Part 4b: *Provided*, That where literal compliance with the structural requirements of Part 4b is extremely difficult to accomplish and would not contribute materially to the objective sought, and the Administrator finds that the experience with the DC-3 or L-18 airplanes justifies it, he is authorized to accept such measures of compliance as he finds will effectively accomplish the basic objective.

(c) *Airplane flight manual—performance operating information.* An approved airplane flight manual shall be provided for each DC-3 and L-18 airplane which has had new maximum certificated weights established under this section. The airplane flight manual shall contain the applicable performance information prescribed in that part of the regulations under which the new certificated weights were established and such additional information as may be necessary to enable the application of the takeoff, en route, and landing limitations prescribed for transport category airplanes in the operating parts of the Civil Air Regulations.

(d) *Performance operating limitations.* Each airplane for which new maximum certificated weights are established in accordance with paragraphs (a) or (b) of this section shall be considered a transport category airplane for the purpose of complying with the performance operating limitations applicable to the operations in which it is utilized.

**5. Reference.** Unless otherwise provided, all references in this regulation to Part 4a and Part 4b are those parts of the Civil Air Regulations in effect on September 1, 1953.

*Note:* Parts 4a and 4b as amended and in effect on September 1, 1953, were published in the Federal Register at the following citations:

*Part 4a,* 14 F.R. 4072, 14 F.R. 3742, 14 F.R. 6769, 15 F.R. 28, 17 F.R. 11631.

*Part 4b,* 15 F.R. 3543, 15 F.R. 8903, 15 F.R. 9184, 16 F.R. 314, 16 F.R. 11759, 16 F.R. 12220, 17 F.R. 1087, 17 F.R. 11631, 18 F.R. 2213.

This regulation supersedes Special Civil Air Regulation SR-398 and shall remain effective until superseded or rescinded by the Board.

## SPECIAL CIVIL AIR REGULATION NO. SR-411B

Effective: June 30, 1962  
Adopted: June 29, 1962  
Published: July 4, 1962  
(27 F.R. 6321)

### Operation Of Certain Transport Category Airplanes in Cargo Service at Increased Zero Fuel and Landing Weights

The Federal Aviation Agency published as a notice of proposed rule making (27 F.R. 3890) and circulated as Civil Air Regulations Draft Release No. 62-18 dated April 19, 1962, a proposed Special Civil Air Regulation to permit certain transport category airplanes to be operated in cargo service at increased zero fuel and landing weights. The proposed regulation was intended to supersede Special Civil Air Regulation No. SR-411A, which contains a termination date of June 30, 1962.

Trial operations of cargo airplanes (Douglas DC-6A) at increased weights were first authorized in waivers issued by the Civil Aeronautics Board to individual air carriers. The first such waiver was issued on July 21, 1954. The weights involved were the zero fuel weight (i.e., the maximum weight of the airplane with no disposable fuel and oil, which has the effect of limiting the weight of the fuselage contents) and the structural landing weight. The weight increases were limited to not more than 5 percent of the zero fuel weight approved for passenger operations, and their use was made contingent upon certain findings by the Administrator of Civil Aeronautics and upon certain conditions of operation, inspections, and reporting. Authorization of the trial operations was predicated on the premise that such operations could eventually lead to the establishment of a sound basis for differentiating between standards for passenger and cargo air carrier operations. Based upon the trial operations under the waivers, the Board determined that a more extensive background of operating experience was necessary. This led to the promulgation of Special Civil Air Regulation No. SR-411 (20 F.R. 4765) which permitted any number of any type of transport category airplane to be operated by any air carrier at increased weights in cargo service.

From the data submitted by the operators in accordance with SR-411, the Board concluded that the scope of operations under SR-411 had been such that substantiation of the conditions for these operations for inclusion in the regulations on a permanent basis would entail a long-range program. The Board, therefore, extended the trial operations by adopting SR-411A on June 28, 1957 (22 F.R. 4684), with a termination date of June 30, 1962.

SR-411A is applicable to airplanes certificated under the transport category airworthiness requirements effective before March 13, 1956. The applicability was so limited because the Board believed it advisable to gain some experience with the airplanes certificated under the provisions of Part 4b effective on and after March 13, 1956, at the normal transport category weights before permitting such airplanes to operate at increased weights. In arriving at this conclusion, the Board took into consideration the new concept of structural design requirements as well as other related changes in these requirements which were introduced in Part 4b on March 13, 1956.

As the preambles to both SR-411 and SR-411A indicated, the purpose in permitting the trial operation of transport category airplanes in cargo service at the arbitrary increased zero fuel and landing weights was to determine through operating experience whether the conditions governing the trial operations would provide a sound basis for establishing future standards for airplanes in cargo operations at increased weights. During the approximately seven years that these trial operations have been conducted, a substantial amount of data has been amassed concerning the airplanes approved for operation under these Special Civil Air Regulations.

The data submitted and the operating experience gained under SR-411 and SR-411A indicate that the airplanes approved for and operated at the increased weights can continue to be operated at such increased weights under certain conditions without adverse effect upon the safety of such airplanes. The inspection reports submitted by the operators under SR-411 and SR-411A have not indicated any serious structural difficulties resulting from operation at the increased weights. The service history of these airplanes with respect to fatigue cracks and other damage is similar to that for airplanes of the same type operated in passenger service. Furthermore, cargo operators have expressed a need to continue operation of these airplanes at the increased weights in their cargo operations. Therefore, Draft Release 62-18 proposed to extend the provisions of SR-411A indefinitely to the types of airplanes that have been qualified and operated at such weights. However, the proposal did not specify the particular models of the various types approved for increased weights under SR-411 and SR-411A. Furthermore, it has subsequently been determined that the L-1649A airplane as modified under supplemental type certificate SA 4-1402 has been approved for operation and has been operated under the provisions of SR-411A. While the application for the type certificate for this airplane was filed in 1955, the manufacturer elected to comply with the later requirements of Part 4b rather than those in effect at the time of his application for type certificate. Subsequently, a supplemental type certificate was issued covering a modification to this airplane based on a demonstration of compliance with the requirements in effect on the date of the application for the type certificate for the airplane. Since this modified airplane was certificated in accordance with the provisions of Part 4b, effective prior to March 13, 1956, it is included in the airplanes permitted to be operated under the terms of this special regulation.

One of the comments received in response to Draft Release 62-18 expressed opposition to the proposed indefinite extension of SR-411A on the grounds that there should be one set of safety standards for the design and operation of all transport category airplanes without regard as to whether the airplane is used for the carriage of cargo or passengers. In this respect, it should be noted that the airplanes covered under this regulation are the airplanes which have been operated for the carriage of cargo at the increased weights without any adverse effect on safety, and that the special inspections conducted by the operators have not indicated any serious structural problems with respect to these airplanes operated at the increased weights as compared with airplanes operated in passenger operations. Furthermore, this regulation requires operators to continue these special inspections. Consequently, the Agency does not believe that it would be justified in arbitrarily terminating the authorization to operate such airplanes at the increased weights.



On the other hand, the majority of the comments received in response to Draft Release 62-18 concurred in the proposed regulation and at the same time recommended that various airplanes other than those covered in the proposal be permitted to operate in cargo service at the arbitrary increased weights. Numerous and detailed arguments have been presented in support of these recommendations for broadening the scope of the proposal. However, these recommendations require consideration of matters which go beyond the scope of the proposed regulation, and there is not sufficient time remaining prior to the expiration of SR-411A for the necessary evaluation of such matters. Therefore, the regulation is being adopted substantially as proposed and further study will be given to such recommendations insofar as they might indicate a need for additional rule making action on this matter.

In view of the foregoing, the special regulation set forth hereinafter permits only those airplane types and models which were approved for trial operations under SR-411 and SR-411A to be used in the carriage of cargo with the arbitrary increased weights.

This regulation relaxes the provisions of SR-411A to the extent that it also applies to foreign air carriers operating the specified airplanes. The provisions of SR-411A were made applicable only to United States air carriers because the conditions for the trial operations required close cooperation between the manufacturer, operator, and the Civil Aeronautics Administration during the initial technical evaluation and in the inspection and reporting procedures. However, since this regulation permits the continued use of increased weights only for those type airplanes previously approved for operation under SR-411A, for which the necessary data and procedures are already available, the increased weights can now be made applicable to any foreign air carrier using airplanes of the specified types in the carriage of cargo only.

This regulation continues the requirement contained in SR-411A that airplanes used by air carriers at the increased weights be operated in accordance with the passenger-carrying transport category operating limitations of Part 40, 41, or 42, as the case may be. In addition, foreign air carriers are permitted to operate airplanes under the authority of this regulation if the country of registry of the airplanes requires such airplanes to be operated in accordance with the performance operating limitations applicable to United States air carriers or the equivalent thereof. The requirement that air carriers must operate their airplanes under the provisions of the regulation in accordance with the passenger-carrying performance operating limitations prescribed in Part 40, 41, or 42 is considered necessary in the interest of safety. Therefore, in order to insure an equivalent level of safety for operations by foreign air carriers, it is considered appropriate to permit such carriers to operate airplanes under the authority of this regulation only on the condition that the country of registry of the airplanes requires that such airplanes be operated in accordance with the same or equivalent performance operating limitations.

This regulation also continues the requirement for special inspections, including the special inspections required prior to returning an airplane from cargo to passenger service. However, in view of the volume of data now available for the eligible airplane types, it no longer requires special reports and records be kept with respect to operations at increased weights. Based on experience gained under SR-411 and SR-411A, it is believed that intermittent cargo-passenger operations can now be permitted provided the special inspection is made each time the airplane is returned to passenger service.

This regulation contains a proviso, similar to that which appears in SR-411A, requiring a determination that any increase in the zero fuel and landing weights for the specified airplanes does not seriously affect the strength, fatigue, flutter, deformation, or vibration characteristics of such airplanes. While not proposed in Draft Release 62-18, the Agency is now of the opinion that even though such a determination has already been made for the increased weights presently authorized for the specified airplanes, such a requirement should be continued in effect to cover possible modifications to these airplanes as well as further increases in the approved weights. Since this provision merely continues in effect a provision currently applicable to the specified airplanes and imposes no additional burden on any person, notice and public procedure thereon are unnecessary for its adoption as part of this regulation.

Interested persons have been afforded an opportunity to participate in the making of this regulation, and due consideration has been given to all relevant matter presented. Since this regulation extends many of the provisions of a currently effective regulation which expires on June 30, 1962, imposes no additional burden on any person, and a delay in its effectiveness would impose a hardship on the cargo operators, good cause exists for making it effective on less than 30 days' notice.

In consideration of the foregoing, the following Special Civil Air Regulation is adopted to become effective on June 30, 1962:

Notwithstanding the applicable structural provisions of the Civil Air Regulations, any air carrier or foreign air carrier may operate, for the carriage of cargo only, the transport category airplanes specified in paragraph (1) of this regulation, at increased zero fuel and landing weights, under the conditions specified in paragraphs (2) through (6) of this regulation.

(1) Transport category airplanes certificated under the provisions of Part 4b, effective prior to March 13, 1956, as follows:

(a) DC-6A, DC-6B, DC-7B, DC-7C; and

(b) L-1049B, C, D, E, F, G, H, L-1649A when modified in accordance with supplemental type certificate SA 4-1402.

(2) The zero fuel weight (maximum weight of the airplane with no disposable fuel and oil) and the structural landing weight may be increased beyond the maximum approved in full compliance with the applicable Civil Air Regulations: *Provided*, That any increase in the zero fuel weight shall not exceed 5 percent and that the increase in the structural landing weight shall not exceed the amount, in pounds, of the increase in zero fuel weight: *And provided further*, That the Administrator finds that the increase in either such weight is not likely to reduce seriously the structural strength, that the probability of sudden fatigue failure is not noticeably increased, and that the flutter, deformation, and vibration characteristics do not fall below those required by the applicable Civil Air Regulations. All other weight limitations established in accordance with the Civil Air Regulations applicable to the type airplane shall apply.

(3) Each airplane shall be inspected in accordance with the special inspection procedures for operations at increased weights established and issued by the manufacturer of the particular type airplane and approved by the Administrator.

(4) Each airplane operated by an air carrier under this regulation shall be operated in accordance with the passenger-carrying transport category performance operating limitations prescribed in Part 40, 41, or 42. Operation of

airplanes by a foreign air carrier is not permitted under the authority of this regulation unless the country of registry requires the airplanes to be operated in accordance with such performance operating limitations or the equivalent thereof.

(5) The Airplane Flight Manual for each airplane operated under the provisions of this regulation shall be appropriately revised to include the operating limitations and information required for operation with the increased weights.

(6) An airplane operated at increased weights under the provisions of this regulation shall be inspected in accordance with the special inspection procedures for return to passenger service established and issued by the airplane manufacturer and approved by the Administrator, before it is used in passenger service, except as provided for the carriage of persons under Special Civil Air Regulation No. SR-432A.

This regulation supersedes Special Civil Air Regulation No. SR-411A.

SPECIAL CIVIL AIR REGULATION NO. SR-422

Effective: August 27, 1957  
Adopted: July 23, 1957

Turbine-Powered Transport Category Airplanes of Current Design

Part 4b of the Civil Air Regulations contains rules governing the design of transport category airplanes. For a number of years, this part has established airworthiness requirements for this category of airplanes by prescribing detailed provisions to be met for the issuance of a type certificate. However, the advent of turbine-powered airplanes (jets, turboprops, etc.) has brought about operations at considerably higher speeds and altitudes than those involving reciprocating engine airplanes. These higher speeds and altitudes as well as certain inherent characteristics of turbine engines have introduced numerous new technical and design problems and have necessitated re-evaluation and amendment of many provisions in Part 4b.

In recent years the Board has amended Part 4b by introducing numerous technical provisions more specifically applicable to turbine-powered airplanes. These were included in amendments pertaining to structural, flight characteristic, powerplant installation, and other provisions. It is believed that Part 4b as now written is applicable to turbine-powered airplanes with but one exception; namely, airplane performance. In the future, further amendments to this part, other than those relating to performance, will be comparatively minor in nature mainly reflecting the latest experience in the certification and operation of these airplanes.

The performance requirements presently in Part 4b were first promulgated almost twelve years ago. They are now considered by the Board to be in a form not suitable for direct application to turbine-powered airplanes.

The administrator of Civil Aeronautics is in receipt of a large number of applications for type certification of turbine-powered airplanes. However, the so-called "non-retroactive" clause of section 4b.11(a) of Part 4b does not make applicable to a particular airplane type any amendment which is adopted after an application is filed by the manufacturer for type certification of that airplane. Thus, most of these airplanes are not now required to meet some of the latest effective provisions of Part 4b unless the Board prescribes otherwise. With so many applications for type certificates pending, it is essential that the Board establish adequate requirements which will effectively apply to the type certification of turbine-powered transport category airplanes. This Special Civil Air Regulation is being promulgated for that purpose.

This Special Civil Air Regulation is being made effective with respect to all turbine-powered transport category airplanes not yet certificated. In essence, it prescribes a revised set of performance requirements for turbine-powered airplanes and incorporates such of the recent amend-

ments to Part 4b as the Administrator finds necessary to insure that the level of safety of turbine-powered airplanes is equivalent to that generally intended by Part 4b.

The performance requirements contained herein include not only the performance requirements necessary for the certification of an airplane, but also the complementary performance operating limitations as applicable under Parts 40, 41, and 42 of the Civil Air Regulations. In promulgating this new performance code, the Board intends that the resulting level of safety will be generally similar to the level of safety established by the performance code as expressed by the provisions now contained in Parts 4b and 40 (or 41 or 42 as appropriate) for reciprocating engine airplanes. To attain this, many of the performance provisions have been modified for better applicability to turbine-powered airplanes, some in the direction of liberalization, others in the direction of improvement in the required performance.

A significant change being made is the introduction of full temperature accountability in all stages of performance, except the landing distances required. The introduction of full temperature accountability will insure that the airplane's performance is satisfactory irrespective of the existing atmospheric temperature. The performance requirements heretofore applicable did not give sufficient assurance in this respect.

The reason for omitting the direct application of temperature accountability in the requirement for landing distances is that this stage of performance always has been treated in a highly empirical fashion whereby temperature effects are taken into account indirectly together with the effects of other operational factors. Long range studies on rationalization of airplane performance so far have not yielded a satisfactory solution to the landing stage of performance. The Board hopes, however, that continued studies will result in a solution of this problem in the near future.

The introduction of full temperature accountability has necessitated a complete re-evaluation of the minimum climb requirements. Since the prescribed climb must now be met at all temperatures rather than to be associated with standard temperature, the specific values of climb have been altered. In each instance, the change has been in the downward direction because, although the previous values were related to standard temperature, a satisfactory resultant climb performance was attained at temperatures substantially above standard. While values of minimum climb performance specified in the new code will tend to increase the maximum certificated weights of the airplane for the lower range of temperatures, they will limit these weights for the upper range of temperatures, giving adequate assurance of satisfactory climb performance at all temperatures.

In considering the various stages of flight where minimum values of climb have been heretofore established, the Board finds that in two of the stages (all-engines-operating en route and one-engine-inoperative en route) the establishment of minimum values of climb is unnecessary because, in the case of the all-engines-operating stage, it has been found not to be critical and the case of the one-engine-inoperative stage is now more effectively covered by the en route performance operating limitations.

Considering that the minimum climbs being prescribed affect mainly the maximum certificated weights of the airplane but not the maximum operating weights, the Board, in adopting the new performance code, places considerable emphasis on the ability of the airplane to clear obstacles on take-off and during flight. To this end, criteria for the take-off path, the en route flight paths, and the transition from take-off to the en route stage of flight have been prescribed to reflect realistic operating procedures. Temperature is fully accounted for in establishing all flight paths and an expanding clearance between the take-off path and the terrain or obstacles is required until the en route stage of flight is reached.

In order to insure that the objectives of the prescribed performance are in fact realized in actual operations, the manufacturer is required to establish procedures to be followed in the operation of the airplane in the various conditions specified in the regulation. These procedures, each designed for a specific airplane, will permit the operator to utilize the full performance capabilities of the airplane more readily than if the regulations prescribed all-inclusive procedures. The use of these procedures in determining compliance with the requirements governing take-off, en route, and landing stages, will also add considerable flexibility to the regulation.

The new performance requirements established more clearly than heretofore which of the performance limitations are conditions on the airworthiness certificate of the airplane. In addition to the maximum certificated take-off and landing weights, there are included limitations on the take-off distances and on the use of the airplane within the ranges of operational variables, such as altitude, temperature, and wind. Since these limitations are in the airworthiness certificate, they are applicable to all type operations conducted with the airplane.

The new performance code contains values for minimum climb expressed as gradients of climb, in percent, rather than as rates of climb, in feet per minute, as has been the case heretofore. The Board believes that the gradient of climb is more direct in expressing the performance margins of the airplane. Use of the gradient eliminates the influence of the stalling speed on the required climb. Heretofore, higher rates of climb were required for airplanes with higher stalling speeds. The only differentiation in the new code with respect to the required climb is between two and four-engine airplanes. This type of differentiation is of long standing in the regulations, being applicable to the one-engine-inoperative stage of flight. It is now being expanded to the take-off and approach stages.

The new performance requirements contained herein are based on the best information presently available to the Board. It is realized, however, that due to the present limited operating experience with turbine-powered transport airplanes, improvement in the requirements can be expected as a result of the direct application of the code to specific designs of new airplanes. There are certain areas in the new requirements where additional refinement of details might be advisable. This is so particularly in the case of the requirements pertaining to the landing stage of flight. It is anticipated that, after further study of the regulation and especially after its application in the design, certification, and operation of forthcoming turbine-powered airplanes, the desirability of changes

may become more apparent. It is the intent of the Board to consider without delay such changes as might be found necessary. Only after the provisions of this Special Civil Air Regulation are reasonably verified by practical application will the Board consider incorporating them on a more permanent basis into Parts 4b, 40, 41, and 42 of the Civil Air Regulations.

This Special Civil Air Regulation is not intended to compromise the authority of the Administrator under section 4b.10 to impose such special conditions as he finds necessary in any particular case to avoid unsafe design features and otherwise to insure equivalent safety.

Interested persons have been afforded an opportunity to participate in the making of this regulation (21 F.R. 6091), and due consideration has been given to all relevant matter presented.

In consideration of the foregoing, the Civil Aeronautics Board hereby makes and promulgates the following Special Civil Air Regulation, effective August 27, 1957.

Contrary provisions of the Civil Air Regulations notwithstanding, all turbine-powered transport category airplanes for which a type certificate is issued after the effective date of this Special Civil Air Regulation shall comply with the following:

1. The provisions of Part 4b of the Civil Air Regulations, effective on the date of application for type certificate; and such of the provisions of all subsequent amendments to Part 4b, in effect prior to the effective date of this special regulation, as the Administrator finds necessary to insure that the level of safety of turbine-powered airplanes is equivalent to that generally intended by Part 4b.

2. In lieu of sections 4b.110 through 4b.125, and 4b.743 of Part 4b of the Civil Air Regulations, the following shall be applicable:

#### PERFORMANCE

##### 4T.110 *General.*

(a) The performance of the airplane shall be determined and scheduled in accordance with, and shall meet the minima prescribed by, the provisions of sections 4T.110 through 4T.123. The performance limitations, information, and other data shall be given in accordance with section 4T.743.

(b) Unless otherwise specifically prescribed, the performance shall correspond with ambient atmospheric conditions and still air. Humidity shall be accounted for as specified in paragraph (c) of this section.

(c) The performance as affected by engine power and/or thrust shall be based on a relative humidity of 80 percent at and below standard temperatures and on 34 percent at and above standard temperatures plus 50° F. Between these two temperatures the relative humidity shall vary linearly.

(d) The performance shall correspond with the propulsive thrust available under the particular ambient atmospheric conditions, the particular flight conditions, and the relative humidity specified in paragraph (c) of this section. The available propulsive thrust shall correspond with engine power and/or thrust not exceeding the approved power and/or thrust less the installational losses and less the power and/or

equivalent thrust absorbed by the accessories and services appropriate to the particular ambient atmospheric conditions and the particular flight condition.

**4T.111 Airplane configuration, speed, power, and/or thrust; general.**

(a) The airplane configuration (setting of wing and cowl flaps, air brakes, landing gear, propeller, etc.), denoted respectively as the take-off, en route, approach, and landing configurations, shall be selected by the applicant except as otherwise prescribed.

(b) It shall be acceptable to make the airplane configurations variable with weight, altitude, and temperature, to an extent found by the Administrator to be compatible with operating procedures required in accordance with paragraph (c) of this section.

(c) In determining the accelerate-stop distances, take-off flight paths, take-off distances, and landing distances, changes in the airplane's configuration and speed, and in the power and/or thrust shall be in accordance with procedures established by the applicant for the operation of the airplane in service, except as otherwise prescribed. The procedures shall comply with the provisions of subparagraphs (1) through (3) of this paragraph.

(1) The Administrator shall find that the procedures can be consistently executed in service by crews of average skill.

(2) The procedures shall not involve methods or the use of devices which have not been proven to be safe and reliable.

(3) Allowance shall be made for such time delays in the execution of the procedures as may be reasonably expected to occur during service.

**4T.112 Stalling speeds.**

the minimum steady flight speed at which the airplane is controllable, in

(a) The speed  $V_{s_0}$  shall denote the calibrated stalling speed, or knots, with:

(1) Zero thrust at the stalling speed, or engines idling and throttles closed if it is shown that the resultant thrust has no appreciable effect on the stalling speed;

(2) If applicable, propeller pitch controls in the position necessary for compliance with subparagraph (1) of this paragraph;

(3) The airplane in the landing configuration;

(4) The center of gravity in the most unfavorable position within the allowable landing range;

(5) The weight of the airplane equal to the weight in connection with which  $V_s$  is being used to determine compliance with a particular requirement.

(b) The speed  $V_{s_1}$  shall denote the calibrated stalling speed, or the minimum steady flight speed at which the airplane is controllable, in knots, with:

(1) Zero thrust at the stalling speed, or engines idling and throttles closed if it is shown that the resultant thrust has no appreciable effect on the stalling speed;

(2) If applicable, propeller pitch controls in the position necessary for compliance with subparagraph (1) of this paragraph; the air-



plane in all other respects (flaps, landing gear, etc.) in the particular configuration corresponding with that in connection with which  $V_{s1}$  is being used;

(3) The weight of the airplane equal to the weight in connection with which  $V_{s1}$  is being used to determine compliance with a particular requirement.

(c) The stall speeds defined in this section shall be the minimum speeds obtained in flight tests conducted in accordance with the procedure of subparagraphs (1) and (2) of this paragraph.

(1) With the airplane trimmed for straight flight at a speed of  $1.4 V_s$  and from a speed sufficiently above the stalling speed to insure steady conditions, the elevator control shall be applied at a rate such that the airplane speed reduction does not exceed one knot per second.

(2) During the test prescribed in subparagraph (1) of this paragraph, the flight characteristics provisions of section 4b.160 of Part 4b of the Civil Air Regulations shall be complied with.

**4T.113 Take-off; general.**

(a) The take-off data in sections 4T.114 through 4T.117 shall be determined under the conditions of subparagraphs (1) and (2) of this paragraph.

(1) At all weights, altitudes, and ambient temperatures within the operational limits established by the applicant for the airplane.

(2) In the configuration for take-off (see sec. 4T.111).

(b) Take-off data shall be based on a smooth, dry, hard-surfaced runway, and shall be determined in such a manner that reproduction of the performance does not require exceptional skill or alertness on the part of the pilot. In the case of seaplanes or float planes, the take-off surface shall be smooth water, while for skiplanes it shall be smooth dry snow. In addition, the take-off data shall be corrected in accordance with subparagraphs (1) and (2) of this paragraph for wind and for runway gradients within the operational limits established by the applicant for the airplane.

(1) Not more than 50 percent of nominal wind components along the take-off path opposite to the direction of take-off, and not less than 150 percent of nominal wind components along the take-off path in the direction of take-off.

(2) Effective runway gradients.

**4T.114 Take-off speeds.**

(a) The critical-engine-failure speed  $V_1$ , in terms of calibrated air speed, shall be selected by the applicant, but shall not be less than the minimum speed at which controllability by primary aerodynamic controls alone is demonstrated during the take-off run to be adequate to permit proceeding safely with the take-off using average piloting skill, when the critical engine is suddenly made inoperative.

(b) The minimum take-off safety speed  $V_2$ , in terms of calibrated air speed, shall be selected by the applicant so as to permit the gradient of climb required in section 4T.120 (a) and (b), but it shall not be less than:

(1)  $1.2 V_{s1}$  for two-engine propeller-driven airplanes and for airplanes without propellers which have no provisions for obtaining a significant reduction in the one-engine-inoperative power-on stalling speed.

(2) 1.15  $V_s$ , for propeller-driven airplanes having more than two engines and for airplanes without propellers which have provisions for obtaining a significant reduction in the one-engine-inoperative power-on stalling speed;

(3) 1.10 times the minimum control speed  $V_{MC}$ , established in accordance with section 4b.133 of Part 4b of the Civil Air Regulations.

(c) If engine failure is assumed to occur at or after the attainment of  $V_2$ , the demonstration in which the take-off run is continued to include the take-off climb, as provided in paragraph (a) of this section, shall not be required.

**4T.115 Accelerate-stop distance.**

(a) The accelerate-stop distance shall be the sum of the following:

(1) The distance required to accelerate the airplane from a standing start to the speed  $V_1$ ;

(2) Assuming the critical engine to fail at the speed  $V_1$ , the distance required to bring the airplane to a full stop from the point corresponding with the speed  $V_1$ .

(b) In addition to, or in lieu of, wheel brakes, the use of other braking means shall be acceptable in determining the accelerate-stop distance, provided that such braking means shall have been proven to be safe and reliable, that the manner of their employment is such that consistent results can be expected in service, and that exceptional skill is not required to control the airplane.

(c) The landing gear shall remain extended throughout the accelerate-stop distance.

**4T.116 Take-off path.** The take-off path shall be considered to extend from the standing start to a point in the take-off where a height of 1,000 feet above the take-off surface is reached or to a point in the take-off where the transition from the take-off to the en route configuration is completed and a speed is reached at which compliance with section 4T.120(c) is shown, whichever point is at a higher altitude. The conditions of paragraphs (a) through (i) of this section shall apply in determining the take-off path.

(a) The take-off path shall be based upon procedures prescribed in accordance with section 4T.111(c).

(b) The airplane shall be accelerated on or near the ground to the speed  $V_2$  during which time the critical engine shall be made inoperative at speed  $V_1$  and shall remain inoperative during the remainder of the take-off.

(c) Landing gear retraction shall not be initiated prior to reaching the speed  $V_2$ .

(d) The slope of the airborne portion of the take-off path shall be positive at all points.

(e) After the  $V_2$  speed is reached, the speed throughout the take-off path shall not be less than  $V_2$  and shall be constant from the point where the landing gear is completely retracted until a height of 400 feet above the take-off surface is reached.

(f) Except for gear retraction and propeller feathering, the airplane configuration shall not be changed before reaching a height of 400 feet above the take-off surface.

(g) At all points along the take-off path starting at the point where the airplane first reaches a height of 400 feet above the take-off surface, the available gradient of climb shall not be less than 1.4 percent for two-engine airplanes and 1.8 percent for four-engine airplanes.

(h) The take-off path shall be determined either by a continuous demonstration take-off, or alternatively, by synthesizing from segments the complete take-off path.

(i) If the take-off path is determined by the segmental method, the provisions of subparagraphs (1) through (4) of this paragraph shall be specifically applicable.

(1) The segments of a segmental take-off path shall be clearly defined and shall be related to the distinct changes in the configuration of the airplane, in power and/or thrust, and in speed.

(2) The weight of the airplane, the configuration, and the power and/or thrust shall be constant throughout each segment and shall correspond with the most critical condition prevailing in the particular segment.

(3) The segmental flight path shall be based on the airplane's performance without ground effect.

(4) Segmental take-off path data shall be checked by continuous demonstrated take-offs to insure that the segmental path is conservative relative to the continuous path.

**4T.117 Take-off distance.** The take-off distance shall be the horizontal distance along the take-off path from the start of the take-off to the point where the airplane attains a height of 35 feet above the take-off surface as determined in accordance with 4T.116.

**4T.118 Climb; general.** Compliance shall be shown with the climb requirements of sections 4T.119 and 4T.120 at all weights, altitudes, and ambient temperatures, within the operational limits established by the applicant for the airplane. The airplane's center of gravity shall be in the most unfavorable position corresponding with the applicable configuration.

**4T.119 All-engine-operating landing climb.** In the landing configuration, the steady gradient of climb shall not be less than 4.0 per cent, with:

(a) All engines operating at the available take-off power and/or thrust;

(b) A climb speed not in excess of  $1.4 V_{so}$ .

**4T.120 One-engine-inoperative climb.**

(a) **Take-off; landing gear extended.** In the take-off configuration at the point of the flight path where the airplane's speed first reaches  $V_2$ , in accordance with section 4T.116 but without ground effect, the steady gradient of climb shall be positive with:

(1) The critical engine inoperative, the remaining engine(s) operating at the available take-off power and/or thrust existing in accordance with section 4T.116 at the time the airplane's landing gear is fully retracted;

(2) The weight equal to the airplane's weight existing in accordance with section 4T.116 at the time retraction of the airplane's landing gear is initiated;

(3) The speed equal to the speed  $V_2$ .

(b) *Take-off; landing gear retracted.* In the take-off configuration at the point of the flight path where the airplane's landing gear is fully retracted, in accordance with section 4T.116 but without ground effect, the steady gradient of climb shall not be less than 2.5 percent for two-engine airplanes and not less than 3.0 percent for four-engine airplanes, with:

(1) The critical engine inoperative, the remaining engine(s) operating at the take-off power and/or thrust available at a height of 400 feet above the take-off surface and existing in accordance with section 4T.116;

(2) The weight equal to the airplane's weight existing in accordance with section 4T.116 at the time the airplane's landing gear is fully retracted;

(3) The speed equal to the speed  $V_2$ .

(c) *Final take-off.* In the en route configuration, the steady gradient of climb shall not be less than 1.4 percent for two-engine airplanes and not less than 1.8 percent for four-engine airplanes, at the end of the take-off path as determined by section 4T.116, with:

(1) The critical engine inoperative, the remaining engine(s) operating at the available maximum continuous power and/or thrust;

(2) The weight equal to the airplane's weight existing in accordance with section 4T.116 at the time retraction of the airplane's flaps is initiated;

(3) The speed equal to not less than  $1.25 V_{s1}$ .

(d) *Approach.* In the approach configuration such that  $V_1$  does not exceed  $1.10 V_{s0}$ , the steady gradient of climb shall not be less than 2.2 percent for two-engine airplanes and not less than 2.8 percent for four-engine airplanes, with:

(1) The critical engine inoperative, the remaining engine(s) operating at the available take-off power and/or thrust;

(2) The weight equal to the maximum landing weight;

(3) A climb speed in excess of  $1.5 V_{s1}$ ;

4T.121 *En route flight paths.* With the airplane in the en route configuration, the flight paths prescribed in paragraphs (a) and (b) of this section shall be determined at all weights, altitudes, and ambient temperatures within the limits established by the applicant for the airplane.

(a) *One engine inoperative.* The one-engine-inoperative net flight path data shall be determined in such a manner that they represent the airplane's actual climb performance diminished by a gradient of climb equal to 1.4 percent for two-engine airplanes and 1.8 percent for four-engine airplanes. It shall be acceptable to include in these data the variation of the airplane's weight along the flight path to take into account the progressive consumption of fuel and oil by the operating engine(s).

(b) *Two engines inoperative.* For airplanes with four engines, the two-engine-inoperative net flight path data shall be determined in such a manner that they represent the airplane's actual climb performance diminished by a gradient of climb equal to 0.6 percent. It shall be acceptable to include in these data the variation of the airplane's weight

along the flight path to take into account the progressive consumption of fuel and oil by the operating engines.

(c) *Conditions.* In determining the flight paths prescribed in paragraphs (a) and (b) of this section, the conditions of subparagraphs (1) through (4) of this paragraph shall apply.

(1) The airplane's center of gravity shall be in the most unfavorable position.

(2) The critical engine(s) shall be inoperative, the remaining engine(s) operating at the available maximum continuous power and/or thrust.

(3) Means for controlling the engine cooling air supply shall be in the position which provides adequate cooling in the hot-day condition.

(4) The speed shall be selected by the applicant.

4T.122 *Landing distance.* The landing distance shall be the horizontal distance required to land and to come to a complete stop (to a speed of approximately 3 knots in the case of seaplanes or float planes) from a point at a height of 50 feet above the landing surface. Landing distances shall be determined for standard temperatures at all weights, altitudes, and winds within the operational limits established by the applicant for the airplane. The conditions of paragraphs (a) through (f) of this section shall apply.

(a) The airplane shall be in the landing configuration. During the landing, changes in the airplane's configuration, in power and/or thrust, and in speed shall be in accordance with procedures established by the applicant for the operation of the airplane in service. The procedures shall comply with the provisions of section 4T.111(c).

(b) The landing shall be preceded by a steady gliding approach down to the 50-foot height with a calibrated air speed of not less than  $1.3 V_{so}$ .

(c) The landing distance shall be based on a smooth, dry, hard-surfaced runway, and shall be determined in such a manner that reproduction does not require exceptional skill or alertness on the part of the pilot. In the case of seaplanes or float planes, the landing surface shall be smooth water, while for skiplanes it shall be smooth dry snow. During landing, the airplane shall not exhibit excessive vertical acceleration, a tendency to bounce, nose over, ground loop, porpoise, or water loop.

(d) The landing distance shall be corrected for not more than 50 percent of nominal wind components along the landing path opposite to the direction of landing and not less than 150 percent of nominal wind components along the landing path in the direction of landing.

(e) During landing, the operating pressures on the wheel braking system shall not be in excess of those approved by the manufacturer of the brakes, and the wheel brakes shall not be used in such a manner as to produce excessive wear of brakes and tires.

(f) If the Administrator finds that a device on the airplane other than wheel brakes has a noticeable effect on the landing distance and if the device depends upon the operation of the engine and the effect of such a device is not compensated for by other devices in the event of engine failure, the landing distance shall be determined by assuming the critical engine to be inoperative.

**4T.123 Limitations and information.**

(a) *Limitations.* The performance limitations on the operation of the airplane shall be established in accordance with subparagraphs (1) through (4) of this paragraph. (See also sec. 4T.743.)

(1) *Take-off weights.* The maximum take-off weights shall be established at which compliance is shown with the generally applicable provisions of this regulation and with section 4T.120 (a), (b), and (c) for altitudes and ambient temperatures within the operational limits of the airplane (see subparagraph (4) of this paragraph).

(2) *Landing weights.* The maximum landing weights shall be established at which compliance is shown with the generally applicable provisions of this regulation and with sections 4T.119 and 4T.120(d) for altitudes and ambient temperatures within the operational limits of the airplane (see subparagraph (4) of this paragraph).

(3) *Take-off and accelerate-stop distances.* The minimum distances required for takeoff shall be established at which compliance is shown with the generally applicable provisions of this regulation and with sections 4T.115 and 4T.117 for weights, altitudes, temperatures, wind components, and runway gradients, within the operational limits of the airplane (see subparagraph (4) of this paragraph).

(4) *Operational limits.* The operational limits of the airplane shall be established by the applicant for all variable factors required in showing compliance with this regulation (weight, altitude, temperature, etc.). (See secs. 4T.113(a) (1) and (b), 4T.118, 4T.121, and 4T.122.)

(b) *Information.* The performance information on the operation of the airplane shall be scheduled in compliance with the generally applicable provisions of this regulation and with sections 4T.116, 4T.121, and 4T.122 for weights, altitudes, temperatures, wind components, and runway gradients, as these may be applicable, within the operational limits of the airplane (see subparagraph (a)(4) of this section). In addition, the performance information specified in subparagraphs (1) through (3) of this paragraph shall be determined by extrapolation and scheduled for the ranges of weights between the maximum landing and maximum take-off weights established in accordance with subparagraphs (a)(1) and (a)(2) of this section. (See also sec. 4T.743.)

- (1) Climb in the landing configuration (see sec. 4T.119);
- (2) Climb in the approach configuration (see sec. 4T.120(d));
- (3) Landing distance (see sec. 4T.122).

**AIRPLANE FLIGHT MANUAL****4T.743 Performance limitations, information, and other data.**

(a) *Limitations.* The airplanes' performance limitations shall be given in accordance with section 4T.123(a).

(b) *Information.* The performance information prescribed in section 4T.123(b) for the application of the operating rules of this regulation shall be given together with descriptions of the conditions, air speeds, etc., under which the data were determined.

(c) *Procedures.* For all stages of flight, procedures shall be given with respect to airplane configurations, power and/or thrust settings, and indicated air speeds, to the extent such procedures are related

to the limitations and information set forth in accordance with paragraphs (a) and (b) of this section.

(d) *Miscellaneous.* An explanation shall be given of significant or unusual flight or ground handling characteristics of the airplane.

3. In lieu of sections 40.70 through 40.78, 41.27 through 41.36(d), and 42.70 through 42.83, of Parts 40, 41, and 42 of the Civil Air Regulations, respectively, the following shall be applicable:

### OPERATING RULES

#### 40T.80 *Transport category airplane operating limitations.*

(a) In operating any passenger-carrying transport category airplane certificated in accordance with the performance requirements of this regulation, the provisions of sections 40T.80 through 40T.84 shall be complied with, unless deviations therefrom are specifically authorized by the Administrator on the ground that the special circumstances of a particular case make a literal observance of the requirements unnecessary for safety.

(b) The performance data in the Airplane Flight Manual shall be applied in determining compliance with the provisions of sections 40T.81 through 40T.84. Where conditions differ from those for which specific tests were made compliance shall be determined by approved interpolation or computation of the effects of changes in the specific variables if such interpolations or computations give results substantially equalling in accuracy the results of a direct test.

#### 40T.81 *Airplane's certificate limitations.*

(a) No airplane shall be taken off at a weight which exceeds the take-off weight specified in the Airplane Flight Manual for the elevation of the airport and for the ambient temperature existing at the time of the take-off. (See secs. 4T.123(a)(1) and 4T.743(a).)

(b) No airplane shall be taken off at a weight such that, allowing for normal consumption of fuel and oil in flight to the airport of destination, the weight on arrival will exceed the landing weight specified in the Airplane Flight Manual for the elevation of the airport of destination and for the ambient temperature anticipated there at the time of landing. (See secs. 4T.123(a)(2) and 4T.743(a).)

(c) No airplane shall be taken off at a weight which exceeds the weight shown in the Airplane Flight Manual to correspond with the minimum distance required for take-off on the runway to be used. The take-off distance shall correspond with the elevation of the airport, the effective runway gradient, and the ambient temperature and wind component existing at the time of take-off. (See secs. 4T.123(a)(3) and 4T.743(a).)

(d) No airplane shall be operated outside the operational limits specified in the Airplane Flight Manual. (See secs. 4T.123(a)(4) and 4T.743(a).)

40T.82 *Take-off obstacle clearance limitations.* No airplane shall be taken off at a weight in excess of that shown in the Airplane Flight Manual to correspond with a take-off path which clears all obstacles either by at least a height equal to  $(35 + 0.01D)$  feet vertically, where D is the distance out along the intended flight path from the end of the runway in feet, or by at least 200 feet horizontally within the airport boundaries and by at

least 300 feet horizontally after passing beyond the boundaries. In determining the allowable deviation of the flight path in order to avoid obstacles by at least the distances prescribed, it shall be assumed that the airplane is not banked before reaching a height of 50 feet as shown by the take-off path data in the Airplane Flight Manual, and that a maximum bank thereafter does not exceed 15 degrees. The take-off path considered shall be for the elevation of the airport, the effective runway gradient, and for the ambient temperature and wind component existing at the time of take-off. (See secs. 4T.123(b) and 4T.743(b).)

**40T. 83 En route limitations.**

(a) *One engine inoperative.* No airplane shall be taken off at a weight in excess of that which, according to the one-engine-inoperative en route net flight path data shown in the Airplane Flight Manual, will permit compliance with either subparagraph (1) or subparagraph (2) of this paragraph at all points along the route. The net flight path used shall be for the ambient temperatures anticipated along the route. (See secs. 4T.123(b) and 4T.743(b).)

(1) The slope of the net flight path shall be positive at an altitude of at least 1,000 feet above all terrain and obstructions along the route within 5 miles on either side of the intended track.

(2) The net flight path shall be such as to permit the airplane to continue flight from the cruising altitude to an alternate airport where a landing can be made in accordance with the provisions of section 40T.84 (b), the net flight path clearing vertically by at least 2,000 feet all terrain and obstructions along the route within 5 miles on either side of the intended track. The provisions of subdivisions (i) through (vii) of this paragraph shall apply.

(i) The engine shall be assumed to fail at the most critical point along the route.

(ii) The airplanes shall be assumed to pass over the critical obstruction following engine failure at a point no closer to the critical obstruction than the nearest approved radio navigational fix, except that the Administrator may authorize a procedure established on a different basis where adequate operational safeguards are found to exist.

(iii) The net flight path shall have a positive slope at 1,000 feet above the airport used as the alternate.

(iv) An approved method shall be used to account for winds which would otherwise adversely affect the flight path.

(v) Fuel jettisoning shall be permitted if the Administrator finds that the operator has an adequate training program, proper instructions are given to the flight crew, and all other precautions are taken to insure a safe procedure.

(vi) The alternate airport shall be specified in the dispatch release and shall meet the prescribed weather minima.

(vii) The consumption of fuel and oil after the engine becomes inoperative shall be that which is accounted for in the net flight path data shown in the Airplane Flight Manual.

(b) *Two engines inoperative.* No airplane shall be flown along an intended route except in compliance with either subparagraph (1) or subparagraph (2) of this paragraph.

(1) No place along the intended track shall be more than 90



minutes away from an airport at which a landing can be made in accordance with the provisions of section 40T.84(b), assuming all engines to be operating at cruising power.

(2) No airplane shall be taken off at a weight in excess of that which, according to the two-engine-inoperative en route net flight path data shown in the Airplane Flight Manual, will permit the airplane to continue flight from the point where two engines are assumed to fail simultaneously to an airport where a landing can be made in accordance with the provisions of section 40T.84(b), the net flight path having a positive slope at an altitude of at least 1,000 feet above all terrain and obstructions along the route within 5 miles on either side of the intended track or at an altitude of 5,000 feet, whichever is higher. The net flight path considered shall be for the ambient temperatures anticipated along the route. The provisions of subdivision (i) through (iii) of this subparagraph shall apply. (See secs. 4T.123(b) and 4T.743(b).)

(i) The two engines shall be assumed to fail at the most critical point along the route.

(ii) If fuel jettisoning is provided, the airplane's weight at the point where the two engines are assumed to fail shall be considered to be not less than that which would include sufficient fuel to proceed to the airport and to arrive there at an altitude of at least 1,000 feet directly over the landing area.

(iii) The consumption of fuel and oil after the engines become inoperative shall be that which is accounted for in the net flight path data shown in the Airplane Flight Manual.

**40T.84 Landing limitations.**

(a) *Airport of destination.* No airplane shall be taken off at a weight in excess of that which, in accordance with the landing distances shown in the Airplane Flight Manual for the elevation of the airport of intended destination and for the wind conditions anticipated there at the time of landing, would permit the airplane to be brought to rest at the airport of intended destination within 60 percent of the effective length of the runway from a point 50 feet directly above the intersection of the obstruction clearance plane and the runway. The weight of the airplane shall be assumed to be reduced by the weight of the fuel and oil expected to be consumed in flight to the airport of intended destination. Compliance shall be shown with the conditions of subparagraphs (1) and (2) of this paragraph. (See secs. 4T.123(b) and 4T.743(b).)

(1) It shall be assumed that the airplane is landed on the most favorable runway and direction in still air.

(2) It shall be assumed that the airplane is landed on the most suitable runway considering the probable wind velocity and direction and taking due account of the ground handling characteristics of the airplane and of other conditions (i.e., landing aids, terrain, etc.). If full compliance with the provisions of this subparagraph is not shown, the airplane may be taken off if an alternate airport is designated which permits compliance with paragraph (b) of this section.

(b) *Alternate airport.* No airport shall be designated as an alternate airport in a dispatch release unless the airplane at the weight anticipated at the time of arrival at such airport can comply with the provisions of paragraph (a) of this section, provided that the airplane can be brought to rest within 70 percent of the effective length of the runway.

SPECIAL CIVIL AIR REGULATION NO. SR-422A

Adopted: July 2, 1958  
Effective: July 2, 1958

Turbine-Powered Transport Category Airplanes of Current Design

On July 23, 1957, the Board adopted Special Civil Air Regulation No. SR-422 which sets forth airworthiness requirements applicable to the type certification and operation of turbine-powered transport category airplanes for which a type certificate is issued after August 27, 1957. Included in that regulation was a new set of performance requirements, with respect to which the Board indicated that consideration would be given to any changes found necessary as a result of further study and experience. The preamble to SR-422 contains the relevant considerations leading to its promulgation and is considered to provide the basic background for this regulation.

Since the adoption of SR-422, considerable study has been devoted to the new performance requirements by all interested parties. As a result of these studies and of further experience gained in the design, certification, and operation of turbine-powered airplanes, certain issues with respect to SR-422 require re-evaluation. This regulation reflects the resolution of most of the outstanding issues in the light of the best information presently available to the Board.

The following provisions of this regulation differ from, or are additional to, the provisions of SR-422: Introductory paragraph; item 1; sections 4T.111(c); 4T.112; 4T.114 (b), (b)(1), (b)(4), and (c); introductory paragraph of 4T.116; 4T.116 (b), (c), (e), and (g); 4T.117; 4T.117a; 4T.119; 4T.120 (a), (a)(1), (b), (b)(1), (c), (c)(2), (c)(3), (d), and (d)(3); 4T.121 (a) and (b); introductory paragraph of 4T.122; 4T.122 (b), (f), and (g); 4T.123 (a)(1), (a)(2), (a)(3), and (b); 4T.743(c); 40T.81 (b) and (c); 40T.82; 40T.83 (a)(2)(iii), (b)(2), and (b)(2)(ii); item 4; and item 5. Of these provisions, the following differ from those proposed in Civil Air Regulations Draft Release No. 58-6: sections 4T.111(c); 4T.112(a)(4); 4T.114 (b)(4), (c), (c)(2), (c)(3), and (c)(4); 4T.116 (c) and (e); 4T.117 (b)(1) and (b)(2); 4T.119(a); 4T.120(a); 40T.81(c) and 43T.11(c).

With respect to the applicability of this regulation, experience with certification under SR-422 indicates that a lead time of about two months between the date of adoption of the regulation and the date of issuance of the type certificate should provide a reasonable period of time within which to show compliance with this regulation. In view of this, and in the interest of having uniform regulations applicable to most of the turbine-powered airplanes, it is considered advisable to have this regulation apply to all such airplanes for which a type certificate is issued after September 30, 1958. Turbine-powered transport category airplanes for which a type certificate is issued on or prior to September 30, 1958, may comply with the provisions of this regulation in lieu of SR-422. If

this option is exercised, it is intended that compliance be shown with all the provisions of this regulation and it is not intended to permit a showing of compliance with portions of this regulation and portions of SR-422.

The provisions of this regulation involve the following technical issues:

A substantive change is made by introducing an all-engines-operating take-off in establishing the take-off distance. Presently, the take-off distance is based only on a one-engine-out take-off. To insure that an adequate margin of safety will exist for day-in and day-out operations, the minimum take-off distance is being related to both the one-engine-inoperative distance now prescribed and to the distance with all engines operating, with a factor of 1.15 being applied to the latter.

There are also included important changes with respect to the speeds applicable to the take-off path. The provisions of SR-422 prescribe that the airplane shall be accelerated on or near the ground to the speed  $V_2$ . This provision has been subject to varying interpretations having a marked difference in effect on the resultant level of performance. The issue in this matter is whether or not the airplane should be permitted to lift off the runway at some speed below  $V_2$ . Because of the increased acceleration of turbine-powered airplanes, the tendency to overshoot the lift-off speed will be greater than on piston-engine airplanes and this tendency increases with the reduction in weight of the airplane. To restrict lift-off to the minimum take-off safety speed  $V_2$  would unduly extend the take-off distance in cases where such overshooting of speed occurs. Such a restriction would be unnecessarily conservative and would not reflect realistic take-off procedures. For these reasons this regulation permits the airplane to lift off the ground at a speed lower than the  $V_2$  speed, but prescribes certain limiting conditions. The lift-off speed is related to a rotational speed  $V_R$  which must not be less than 95 percent of the minimum  $V_2$  speed and must be 10 percent greater than a speed at which no hazardous characteristics are displayed by the airplane, such as a relatively high drag condition or a ground stall. The  $V_2$  speed has been re-defined to take into account the increment in speed arising from overshoot tendencies. Under the new definition, the minimum  $V_2$  speed corresponds with the minimum take-off safety speed as now defined in SR-422. With respect to the take-off path, the  $V_2$  speed is required to be attained prior to reaching a height of 35 feet above the take-off surface and thus is related to the selection of the rotational speed. Further, there is a revision which requires  $V_2$  to be maintained as close as practicable at a constant value from the 35-foot point to a height of 400 feet above the take-off surface. This speed is the speed at which the prescribed minimum take-off gradients must be met.

There is introduced in this regulation the concept of unbalanced take-off field lengths. SR-422 does not preclude unbalancing of field lengths, provided that the unbalancing is within the length of the runway. Other countries have employed unbalancing with respect to so-called "stopways" and "clearways." It appears that United States operators ultimately will find it advantageous to resort to the use of unbalancing, but probably not to the same extent as practiced in other countries. On the premise that only clearways will be utilized, the amendments have been formulated accordingly. Clearways, as defined herein, are areas not suitable

for stopping the airplane in the event of an aborted take-off, but adequate to provide additional take-off distance for climb-out. To safeguard operations utilizing clearways, there is introduced the concept of a take-off run which operationally relates to the determination of the minimum runway length required. The take-off run is defined as the greater of the horizontal distances along the take-off path to a given point with one engine inoperative or with all engines operating, with a margin of 15 percent being added to the latter. The take-off run is measured from the beginning of take-off to a point equidistant between the point where the airplane lifts off and the point where a height of 35 feet is reached. The required runway length must not be less than the take-off run nor less than the accelerate stop distance.

According to the definition given, a clearway is subjected to the control of the airport authorities. It is not intended, however, that there be ownership by the airport authorities of the area in which the clearway lies. The objective for requiring control by the airport authorities is to insure that no flight will be initiated using a clearway unless it is determined with certainty that no movable obstacle will exist within the clearway when the airplane flies over.

It is anticipated that the introduction of clearways will offer further possibilities of increasing the utility of existing airport facilities in this country. When such areas can be integrated into existing facilities, economical benefits will accrue to the community and the operators. In addition, since clearways are presently available at some of the airports in other countries, United States operators will have the opportunity of taking advantage of such facilities.

There are included changes with respect to the prescribed minimum altitude of 1,000 feet relative to the take-off path and to the one-engine-inoperative and two-engine-inoperative requirements applicable to the vicinity of the airport. Heretofore, the Civil Air Regulations have incorporated the reference altitude of 1,000 feet in respect of performance criteria over the airport. Obscure as is the significance of this altitude operationally, the altitude of 1,500 feet has worldwide precedent of being used as the altitude above the airport at which, generally, IFR approaches are initiated and go-around procedures executed. For this reason, the changes made extend the take-off path to a minimum altitude of 1,500 feet and make this altitude applicable to the prescribed performance criteria above the airport for the one- and two-engine-inoperative en route requirements. It is not anticipated that these changes will create any problems with respect to the en route stages of flight; however, it is realized that a further extension of the take-off path might add to the problem of obtaining accurate data on obstacles relatively distant from the airport. The Board finds that the extension of the flight path to 1,500 feet is warranted in light of the operational significance of this altitude and because the extended flight paths will provide more fully for adequate terrain clearance at the end of the take-off path.

There is included a change with respect to the take-off path whereby the take-off flight path is established as starting from a 35-foot height at the end of the take-off distance and a net take-off flight is prescribed for operational use. This latter change is for consistency with the specification of net flight paths for the en route stages of flight and to simplify

determination of obstacle clearances operationally. The net flight path is specified to be the actual flight path diminished by a gradient of 1.0 percent. It is intended that the net flight path be obtained from the gross flight path by simple geometric means.

The change in the altitude from 1,000 to 1,500 feet previously mentioned, as well as a re-evaluation in other respects of some of the climb gradients in SR-422, justify certain changes. The gradients of 1.4 and 1.8 applicable to the take-off path and the final take-off climb are being reduced to 1.2 and 1.7 for two-engine and four-engine airplanes, respectively. In addition, the gradients of 1.4 and 1.8 in the one-engine-inoperative en route case are being reduced to 1.1 and 1.6, respectively.

Changes are made with respect to the one-engine-inoperative take-off climb by interrelating more realistically the prescribed airplane configuration, weight, and power. These changes, in effect, permit meeting the prescribed gradients of climb at slightly higher airplane weights than would be possible under the presently effective provisions.

There is included a change to the provisions applicable to the one-engine-inoperative take-off climb with landing gear extended which increases the prescribed minimum gradient from substantially zero to 0.5 percent for four-engine airplanes. This change is made to attain consistency in the difference between gradients applicable to twins and fours.

Changes are incorporated in connection with the two-engine-inoperative en route requirement. Representations have been made that the gradient of 0.6 percent now prescribed is unduly conservative. On the other hand, it has been pointed out that the fuel requirements for this case are not realistically covered. Both of these contentions warrant consideration and changes are included which reduce the margin gradient from 0.6 to 0.5 percent, reduce the prescribed altitude from 5,000 to 2,000 feet, and require scheduling the flight so that there is sufficient fuel on board to reach the airport and subsequently to fly for 15 minutes at cruise power or thrust.

Changes are also made relative to the approach and landing stages of flight. There is a new provision which requires the establishment of procedures for the execution of missed approaches and balked landings. A question has been raised as to whether the speed limitation of  $1.5 V_L$  applicable to the approach condition is realistically related to the normal day-in and day-out landing procedures. To insure that it will be so related, it is required that the speed used for demonstrating the approach climb be established consistent with the landing procedures, but that it not exceed  $1.5 V_L$ . In addition, the approach gradient of 2.8 percent prescribed for four-engine airplanes is being reduced to 2.7 percent to obtain consistency in the differences between gradients applicable to twins and fours.

A change is made to the "all-engines-operating landing climb" provisions which now require a 4.0 percent gradient of climb in the landing configuration. On the premise that requiring the landing configuration during the climb after a balk is unduly conservative, consideration was given to a proposal to permit showing of compliance with the 4.0 percent gradient of climb in the configuration which would exist 5 seconds after the initiation of the climb. Further study of this proposal indicated that such a rule would tend to introduce complications in design and lead to

less favorable operating procedures which ultimately would not contribute to safety. One of the most important factors in connection with this configuration is the response of the engines to throttle movement. Therefore, there is a provision which requires that the power used in showing compliance with the climb gradient be that power or thrust attained 8 seconds after initiation of movement of the power controls to the take-off position from the minimum flight idle position. In addition, for consistency with the procedures used for determining the landing distance, the speed limitation of  $1.4 V_L$  is reduced to  $1.3 V_L$ . Concern has been indicated to the effect that any reduction in the prescribed gradient of 4.0 percent might not insure in all cases the ability of the airplane to continue a safe climb after a balk. To provide a further safeguard, the take-off weight-altitude-temperature limitations (WAT limitations stemming from the application of the one-engine-inoperative take-off climb requirements) are being made applicable to the maximum landing weight at the airport of landing. In the past, the landing weight limitations were applicable to the airport of destination but not to the weather alternates. This regulation makes both the take-off weight and landing weight limitations equally applicable to the airport of destination and the weather alternates. In view of the aforementioned changes, a reduction of the required climb gradient from 4.0 to 3.2 percent is justified and included in this regulation.

In addition to the substantive changes which have been discussed, there are three significant changes of a clarifying nature. The first deals with the determination of the landing distance as affected by devices or means other than wheel brakes. There is included a provision similar to the one applicable to the accelerate-stop distance for application to the landing distance. This provision permits the use of means other than wheel brakes in the determination of the landing distance. Additionally, there is a change to the provision which requires in some cases the determination of the landing distance with one engine inoperative. It is believed that the new requirement expresses the intent more clearly. One of the more obvious applications of this provision is in respect of turbo-propeller airplanes. Such airplanes usually are landed with the propellers in a relatively high drag position. If one of the engines becomes inoperative, its propeller would be expected to be in a relatively low drag position with the consequence of a longer landing distance than with all engines operating. In such a case it is required that the landing distance be determined with one engine inoperative unless use could be made by the crew of other means (e.g., reverse thrust not otherwise considered in determining the landing distance) which would reduce the landing distance at least to that determined for all-engine operation.

The second clarification being included deals with the provision setting forth the procedures which must be included in the Airplane Flight Manual. This provision in SR-422 does not make clear what procedures are involved and whether the procedures are considered to be limitations on the operation of the airplane. The clarification in language specifies that the procedures which are included with the performance limitations shall be considered only as guidance material.

The third clarification concerns the applicability of the performance limitations prescribed in SR-422. These consist of the "certificate limita-

tions" and the "operating limitations." The former relate to maximum take-off and landing weights, minimum take-off distances, accelerate-stop distances, and the operational limits imposed upon the airplane. These limitations, being part of the conditions of the type and airworthiness certificates, must be complied with at all times irrespective of the type of operation being conducted (e.g., air carrier, private, cargo). The "operating limitations," distinct from the "certificate limitations," are only applicable when required by the operating parts of the regulations (Parts 40, 41, and 42 require compliance for passenger operations). Although it appeared that previous Board pronouncements regarding this general principle as well as the explanation contained in the preamble to SR-422 would make the issue quite clear, it has come to the Board's attention that there is still some misunderstanding of this matter. Apparently this misunderstanding stems from the fact that SR-422 prescribes operating rules for air carrier operations which contain both the "certificate limitations" and the "operating limitations" while no prescription is given to non-air-carrier operations; thus giving an impression that not even the "certificate limitations" are applicable to non-air-carriers. The inclusion of "certificate limitations" for air carrier operations with the "operating limitations" was meant only to provide the operators with the convenience of having together the complete prescription of the applicable performance limitations, notwithstanding that such an inclusion, in fact, duplicates the general requirement of compliance with the "certificate limitations" contained in the Airplane Flight Manual. In view of the possible misunderstanding which might exist from the aforementioned inclusion, there are included in this regulation the same "certificate limitations" for application to all operations under the provisions of Part 43 of the Civil Air Regulations.

In addition, other changes of a minor nature are included herein, the most significant of which is the generalization of the stall speed  $V_s$ , eliminating reference to  $V_{s_0}$  and  $V_{s_1}$ .

Of the changes to SR-422 made in this regulation, there are a number which might require further consideration as studies continue and as additional experience is gained with the application of these new rules. Several of these involve new concepts with which U.S. operators have had little or no experience. These entail the requirements relative to unbalanced field lengths with respect to clearways, to the rotational speed, and to the all-engine take-off distance. Strong representation has been made to the Board to the effect that the numerical factors applicable to the aforementioned rules are too high and should be reduced pending further experience. The Board considers that it would not be in the public interest to reduce any of these factors until such time as further experience indicates that they are in fact overly conservative. Realizing, however, that these issues are of considerable importance in prescribing a practicable level of performance, the Board stands ready to reconsider the relevant provisions of this regulation at such time as substantiating information is received.

There are areas other than those previously mentioned where additional refinement of details may be advisable. This is so particularly in the case of the requirements pertaining to the landing stage of flight, to the take-off lateral clearances, and to the two-engine-inoperative en route

gradient margin. It is anticipated that, after further study of the regulation and especially after its application in the design, certification, and operation of forthcoming turbine-powered airplanes, the desirability of changes may become more apparent. It is the intent of the Board to consider without delay such changes as might be found necessary. Only after the provisions of this Special Civil Air Regulation are reasonably verified by practical application will the Board consider incorporating them on a more permanent basis into Parts 4b, 40, 41, 42, and 43 of the Civil Air Regulations.

This Special Civil Air Regulation is not intended to compromise the authority of the Administrator under section 4b.10 to impose such special conditions as he finds necessary in any particular case to avoid unsafe design features and otherwise to insure equivalent safety.

Interested persons have been afforded an opportunity to participate in the making of this regulation (23 F.R. 2139), and due consideration has been given to all relevant matter presented.

In consideration of the foregoing, the Civil Aeronautics Board hereby makes and promulgates the following Special Civil Air Regulation, effective July 2, 1958:

Contrary provisions of the Civil Air Regulations notwithstanding, all turbine-powered transport category airplanes for which a type certificate is issued after August 27, 1957, shall comply with Special Civil Air Regulation No. SR-422 or, alternatively, with the following provisions, except that those airplanes for which a type certificate is issued after September 30, 1958, shall comply with the following provisions:

1. The provisions of Part 4b of the Civil Air Regulations, effective on the date of application for type certificate; and such of the provisions of all subsequent amendments to Part 4b, in effect prior to August 27, 1957, as the Administrator finds necessary to insure that the level of safety of turbine-powered airplanes is equivalent to that generally intended by Part 4b.

2. In lieu of sections 4b.110 through 4b.125, and 4b.743 of Part 4b of the Civil Air Regulations, the following shall be applicable:

#### PERFORMANCE

##### 4T.110 *General.*

(a) The performance of the airplane shall be determined and scheduled in accordance with, and shall meet the minima prescribed by, the provisions of sections 4T.110 through 4T.123. The performance limitations, information, and other data shall be given in accordance with section 4T.743.

(b) Unless otherwise specifically prescribed, the performance shall correspond with ambient atmospheric conditions and still air. Humidity shall be accounted for as specified in paragraph (c) of this section.

(c) The performance as affected by engine power and/or thrust shall be based on a relative humidity of 80 percent at and below standard temperatures and on 34 percent at and above standard temperatures plus 50° F. Between these two temperatures the relative humidity shall vary linearly.



(d) The performance shall correspond with the propulsive thrust available under the particular ambient atmospheric conditions, the particular flight condition, and the relative humidity specified in paragraph (c) of this section. The available propulsive thrust shall correspond with engine power and or thrust not exceeding the approved power and or thrust less the installational losses and less the power and or equivalent thrust absorbed by the accessories and services appropriate to the particular ambient atmospheric conditions and the particular flight condition.

**4T.111 *Airplane configuration, speed, power, and or thrust; general.***

(a) The airplane configuration (setting of wing and cowl flaps, air brakes, landing gear, propeller, etc.), denoted respectively as the take-off, en route, approach, and landing configurations, shall be selected by the applicant except as otherwise prescribed.

(b) It shall be acceptable to make the airplane configurations variable with weight, altitude, and temperature, to an extent found by the Administrator to be compatible with operating procedures required in accordance with paragraph (c) of this section.

(c) In determining the accelerate-stop distances, take-off flight paths, take-off distances, and landing distances, changes in the airplane's configuration and speed, and in the power and or thrust shall be in accordance with procedures established by the applicant for the operation of the airplane in service, except as otherwise prescribed. In addition, procedures shall be established for the execution of balked landings and missed approaches associated with the conditions prescribed in sections 4T.119 and 4T.120(d), respectively. All procedures shall comply with the provisions of subparagraphs (1) through (3) of this paragraph.

(1) The Administrator shall find that the procedures can be consistently executed in service by crews of average skill.

(2) The procedures shall not involve methods or the use of devices which have not been proven to be safe and reliable.

(3) Allowance shall be made for such time delays in the execution of the procedures as may be reasonably expected to occur during service.

**4T.112 *Stalling speeds.***

(a) The speed  $V_s$  shall denote the calibrated stalling speed, or the minimum steady flight speed at which the airplane is controllable, in knots, with:

(1) Zero thrust at the stalling speed, or engines idling and throttles closed if it is shown that the resultant thrust has no appreciable effect on the stalling speed:

(2) If applicable, propeller pitch controls in the position necessary for compliance with subparagraph (1) of this paragraph: the airplane in all other respects (flaps, landing gear, etc.) in the particular configuration corresponding with that in connection with which  $V_s$  is being used:

(3) The weight of the airplane equal to the weight in connection with which  $V_s$  is being used to determine compliance with a particular requirement:

(4) The center of gravity in the most unfavorable position within the allowable range.

(b) The stall speed defined in this section shall be the minimum speed obtained in flight tests conducted in accordance with the procedure of subparagraphs (1) and (2) of this paragraph.

(1) With the airplane trimmed for straight flight at a speed of  $1.4 V_s$  and from a speed sufficiently above the stalling speed to insure steady conditions, the elevator control shall be applied at a rate such that the airplane speed reduction does not exceed one knot per second.

(2) During the test prescribed in subparagraph (1) of this paragraph, the flight characteristics provisions of section 4b.160 of Part 4b of the Civil Air Regulations shall be complied with.

**4T.113 Take-off; general.**

(a) The take-off data in sections 4T.114 through 4T.117 shall be determined under the conditions of subparagraphs (1) and (2) of this paragraph.

(1) At all weights, altitudes, and ambient temperatures within the operational limits established by the applicant for the airplane.

(2) In the configuration for take-off (see sec. 4T.111).

(b) Take-off data shall be based on a smooth, dry, hard-surfaced runway and shall be determined in such a manner that reproduction of the performance does not require exceptional skill or alertness on the part of the pilot. In the case of seaplanes or float planes, the take-off surface shall be smooth water, while for skiplane it shall be smooth dry snow. In addition, the take-off data shall be corrected in accordance with subparagraphs (1) and (2) of this paragraph for wind and for runway gradients within the operational limits established by the applicant for the airplane.

(1) Not more than 50 percent of nominal wind components along the take-off path opposite to the direction of take-off, and not less than 150 percent of nominal wind components along the take-off path in the direction of take-off.

(2) Effective runway gradients.

**4T.114 Take-off speeds.**

(a) The critical-engine-failure speed  $V_1$ , in terms of calibrated air speed, shall be selected by the applicant, but shall not be less than the minimum speed at which controllability by primary aerodynamic controls alone is demonstrated during the take-off run to be adequate to permit proceeding safely with the take-off using average piloting skill, when the critical engine is suddenly made inoperative.

(b) The take-off safety speed  $V_2$ , in terms of calibrated air speed, shall be selected by the applicant so as to permit the gradient of climb required in section 4T.120 (a) and (b), but it shall not be less than:

(1)  $1.2 V_s$  for two-engine propeller-driven airplanes and for airplanes without propellers which have no provisions for obtaining a significant reduction in the one-engine-inoperative power-on stalling speed;

(2)  $1.15 V_s$  for propeller-driven airplanes having more than two engines and for airplanes without propellers which have provisions for obtaining a significant reduction in the one-engine-inoperative power-on stalling speed;

(3) 1.10 times the minimum control speed  $V_{MC}$ , established in accordance with section 4b.133 of Part 4b of the Civil Air Regulations;

(4) The rotation speed  $V_R$  plus the increment in speed attained in compliance with section 4T.116(e).

(c) The minimum rotation speed  $V_R$ , in terms of calibrated air speed, shall be selected by the applicant, except that it shall not be less than:

(1) The speed  $V_1$ ;

(2) A speed equal to 95 percent of the highest speed obtained in compliance with subparagraph (1) or (2), whichever is applicable, and with subparagraph (3) of paragraph (b) of this section;

(3) A speed which permits the attainment of the Speed  $V_2$  prior to reaching a height of 35 feet above the take-off surface as determined in accordance with section 4T.116(e);

(4) A speed equal to 110 percent of the minimum speed above which the airplane, with all engines operating, can be made to lift off the ground and to continue the take-off without displaying any hazardous characteristics.

**4T.115 Accelerate-stop distance.**

(a) The accelerate-stop distance shall be the sum of the following:

(1) The distance required to accelerate the airplane from a standing start to the speed  $V_1$ ;

(2) Assuming the critical engine to fail at the speed  $V_1$ , the distance required to bring the airplane to a full stop from the point corresponding with the speed  $V_1$ .

(b) In addition to, or in lieu of, wheel brakes, the use of other braking means shall be acceptable in determining the accelerate-stop distance, provided that such braking means shall have been proven to be safe and reliable, that the manner of their employment is such that consistent results can be expected in service, and that exceptional skill is not required to control the airplane.

(c) The landing gear shall remain extended throughout the accelerate-stop distance.

**4T.116 Take-off path.** The take-off path shall be considered to extend from the standing start to a point in the take-off where a height of 1,500 feet above the take-off surface is reached or to a point in the take-off where the transition from the take-off to the en route configuration is completed and a speed is reached at which compliance with section 4T.120(c) is shown, whichever point is at a higher altitude. The conditions of paragraphs (a) through (i) of this section shall apply in determining the take-off path.

(a) The take-off path shall be based upon procedures prescribed in accordance with section 4T.111(c).

(b) The airplane shall be accelerated on the ground to the speed  $V_1$  at which point the critical engine shall be made inoperative and shall remain inoperative during the remainder of the take-off. Subsequent to attaining speed  $V_1$ , the airplane shall be accelerated to speed  $V_2$  during which time it shall be permissible to initiate raising the nose gear off the ground at a speed not less than the rotation speed  $V_R$ .

(c) Landing gear retraction shall not be initiated until the airplane becomes airborne.

(d) The slope of the airborne portion of the take-off path shall be positive at all points.

(e) The airplane shall attain the speed  $V_2$  prior to reaching a height of 35 feet above the take-off surface and shall continue at a speed as close as practical to, but not less than,  $V_2$  until a height of 400 feet above the take-off surface is reached.

(f) Except for gear retraction and propeller feathering, the airplane configuration shall not be changed before reaching a height of 400 feet above the take-off surface.

(g) At all points along the take-off path starting at the point where the airplane first reaches a height of 400 feet above the take-off surface, the available gradient of climb shall not be less than 1.2 percent for two-engine airplanes and 1.7 percent for four-engine airplanes.

(h) The take-off path shall be determined either by a continuous demonstrated take-off, or alternatively, by synthesizing from segments the complete take-off path.

(i) If the take-off path is determined by the segmental method, the provisions of subparagraphs (1) through (4) of this paragraph shall be specifically applicable.

(1) The segments of a segmental take-off path shall be clearly defined and shall be related to the distinct changes in the configuration of the airplane, in power and/or thrust, and in speed.

(2) The weight of the airplane, the configuration, and the power and/or thrust shall be constant throughout each segment and shall correspond with the most critical condition prevailing in the particular segment.

(3) The segmental flight path shall be based on the airplane's performance without ground effect.

(4) Segmental take-off path data shall be checked by continuous demonstrated take-offs to insure that the segmental path is conservative relative to the continuous path.

**4T.117 Take-off distance and take-off run.**

(a) *Take-off distance.* The take-off distance shall be the greater of the distances established in accordance with subparagraphs (1) and (2) of this paragraph.

(1) The horizontal distance along the take-off path from the start of the take-off to the point where the airplane attains a height of 35 feet above the take-off surface, as determined in accordance with section 4T.116.

(2) A distance equal to 115 percent of the horizontal distance along the take-off path, with all engines operating, from the start of the take-off to the point where the airplane attains a height of 35 feet above the take-off surface, as determined by a procedure consistent with that established in accordance with section 4T.116.

(b) *Take-off run.* If the take-off distance is intended to include a clearway (see item 5 of this regulation), the take-off run shall be determined and shall be the greater of the distances established in accordance with subparagraphs (1) and (2) of this paragraph.

(1) The horizontal distance along the take-off path from the start of the take-off to a point equidistant between the point where the airplane first becomes airborne and the point where it attains a height of 35 feet above the take-off surface, as determined in accordance with section 4T.116.

(2) A distance equal to 115 percent of the horizontal distance along the take-off path, with all engines operating, from the start of the take-off to a point equidistant between the point where the airplane first becomes airborne and the point where it attains a height of 35 feet above the take-off surface, as determined by a procedure consistent with that established in accordance with section 4T.116.

**4T.117a Take-off flight path.**

(a) The take-off flight path shall be considered to begin at a height of 35 feet above the take-off surface at the end of the take-off distance as determined in accordance with section 4T.117(a).

(b) The net take-off flight path data shall be determined in such a manner that they represent the airplane's actual take-off flight paths, determined in accordance with paragraph (a) of this section, diminished by a gradient of climb equal to 1.0 percent.

**4T.118 Climb; general.** Compliance shall be shown with the climb requirements of sections 4T.119 and 4T.120 at all weights, altitudes, and ambient temperatures, within the operational limits established by the applicant for the airplane. The airplane's center of gravity shall be in the most unfavorable position corresponding with the applicable configuration.

**4T.119 All-engine-operating landing climb.** In the landing configuration the steady gradient of climb shall not be less than 3.2 percent, with:

(a) All engines operating at the power and/or thrust which is available 8 seconds after initiation of movement of the power and/or thrust controls from the minimum flight idle to the take-off position;

(b) A climb speed not in excess of  $1.3 V_x$ .

**4T.120 One-engine-inoperative climb.**

(a) *Take-off; landing gear extended.* In the take-off configuration existing at the point of the flight path where the airplane first becomes airborne, in accordance with section 4T.116 but without ground effect, the steady gradient of climb shall be positive for two-engine airplanes and shall not be less than 0.5 percent for four-engine airplanes, with:

(1) The critical engine inoperative, the remaining engine(s) operating at the available take-off power and/or thrust existing in accordance with section 4T.116 at the time retraction of the airplane's landing gear is initiated, unless subsequently a more critical power operating condition exists along the flight path prior to the point where the landing gear is fully retracted;

(2) The weight equal to the airplane's weight existing in accordance with section 4T.116 at the time retraction of the airplane's landing gear is initiated;

(3) The speed equal to the speed  $V_2$ .

(b) *Take-off; landing gear retracted.* In the take-off configuration existing at the point of the flight path where the airplane's landing gear is fully retracted, in accordance with section 4T.116 but without ground effect, the steady gradient of climb shall not be less than 2.5 percent for two-engine airplanes and not less than 3.0 percent for four-engine airplanes, with:

(1) The critical engine inoperative, the remaining engine(s) operating at the available take-off power and/or thrust existing in accordance with section 4T.116 at the time the landing gear is fully retracted, unless subsequently a more critical power operating condition exists along the flight path prior to the point where a height of 400 feet above the take-off surface is reached;

(2) The weight equal to the airplane's weight existing in accordance with section 4T.116 at the time the airplane's landing gear is fully retracted;

(3) The speed equal to the speed  $V_2$ .

(c) *Final take-off.* In the en route configuration, the steady gradient of climb shall not be less than 1.2 percent for two-engine airplanes and not less than 1.7 percent for four-engine airplanes, at the end of the take-off path as determined by section 4T.116, with:

(1) The critical engine inoperative, the remaining engine(s) operating at the available maximum continuous power and/or thrust;

(2) The weight equal to the airplane's weight existing in accordance with section 4T.116 at the end of the take-off path;

(3) The speed equal to not less than  $1.25 V_x$ .

(d) *Approach.* In the approach configuration such that the corresponding  $V_x$  for this configuration does not exceed 110 percent of the  $V_x$  corresponding with the related landing configuration, the steady gradient of climb shall not be less than 2.2 percent for two-engine airplanes and not less than 2.7 percent for four-engine airplanes with:

(1) The critical engine inoperative, the remaining engine(s) operating at the available take-off power and/or thrust;

(2) The weight equal to the maximum landing weight;

(3) A climb speed established by the applicant in connection with normal landing procedures, except that it shall not exceed  $1.5 V_x$  (see sec. 4T.111(c)).

**4T.121 En route flight paths.** With the airplane in the en route configuration, the flight paths prescribed in paragraphs (a) and (b) of this section shall be determined at all weights, altitudes, and ambient temperatures within the limits established by the applicant for the airplane.

(a) *One engine inoperative.* The one-engine-inoperative net flight path data shall be determined in such a manner that they represent the airplane's actual climb performance diminished by a gradient of climb equal to 1.1 percent for two-engine airplanes and 1.6 percent for four-engine airplanes. It shall be acceptable to include in these data the varia-

tion of the airplane's weight along the flight path to take into account the progressive consumption of fuel and oil by the operating engine(s).

(b) *Two engines inoperative.* For airplanes with four engines, the two-engine-inoperative net flight path data shall be determined in such a manner that they represent the airplane's actual climb performance diminished by a gradient of climb equal to 0.5 percent. It shall be acceptable to include in these data the variation of the airplane's weight along the flight path to take into account the progressive consumption of fuel and oil by the operating engines.

(c) *Conditions.* In determining the flight paths prescribed in paragraphs (a) and (b) of this section, the conditions of subparagraphs (1) through (4) of this paragraph shall apply.

(1) The airplane's center of gravity shall be in the most unfavorable position.

(2) The critical engine(s) shall be inoperative, the remaining engine(s) operating at the available maximum continuous power and/or thrust.

(3) Means for controlling the engine cooling air supply shall be in the position which provides adequate cooling in the hot-day condition.

(4) The speed shall be selected by the applicant.

**4T.122 Landing distance.** The landing distance shall be the horizontal distance required to land and to come to a complete stop (to a speed of approximately 3 knots in the case of seaplanes or float planes) from a point at a height of 50 feet above the landing surface. Landing distances shall be determined for standard temperatures at all weights, altitudes, and winds within the operational limits established by the applicant for the airplane. The conditions of paragraphs (a) through (g) of this section shall apply.

(a) The airplane shall be in the landing configuration. During the landing, changes in the airplane's configuration, in power and/or thrust, and in speed shall be in accordance with procedures established by the applicant for the operation of the airplane in service. The procedures shall comply with the provisions of section 4T.111(c).

(b) The landing shall be preceded by a steady gliding approach down to the 50-foot height with a calibrated air speed of not less than  $1.3 V_s$ .

(c) The landing distance shall be based on a smooth, dry, hard-surfaced runway, and shall be determined in such a manner that reproduction does not require exceptional skill or alertness on the part of the pilot. In the case of seaplanes or float planes, the landing surface shall be smooth water, while for skiplanes it shall be smooth dry snow. During landing, the airplane shall not exhibit excessive vertical acceleration, a tendency to bounce, nose over, ground loop, porpoise, or water loop.

(d) The landing distance shall be corrected for not more than 50 percent of nominal wind components along the landing path opposite to the direction of landing and not less than 150 percent of nominal wind components along the landing path in the direction of landing.

(e) During landing, the operating pressures on the wheel brak-

ing system shall not be in excess of those approved by the manufacturer of the brakes, and the wheel brakes shall not be used in such a manner as to produce excessive wear of brakes and tires.

(f) In addition to, or in lieu of, wheel brakes, the use of other braking means shall be acceptable in determining the landing distance, provided such braking means shall have been proven to be safe and reliable, that the manner of their employment is such that consistent results can be expected in service, and that exceptional skill is not required to control the airplane.

(g) If the characteristics of a device (e.g., the propellers) dependent upon the operation of any of the engines noticeably increase the landing distance when the landing is made with the engine inoperative, the landing distance shall be determined with the critical engine inoperative unless the Administrator finds that the use of compensating means will result in a landing distance not greater than that attained with all engines operating.

**4T.123 Limitations and information.**

(a) *Limitations.* The performance limitations on the operation of the airplane shall be established in accordance with subparagraphs (1) through (4) of this paragraph. (See also sec. 4T.743.)

(1) *Take-off weights.* The maximum take-off weights shall be established at which compliance is shown with the generally applicable provisions of this regulation and with the take-off climb provisions prescribed in section 4T.120 (a), (b), and (c) for altitudes and ambient temperatures within the operational limits of the airplane (see subparagraph (4) of this paragraph).

(2) *Landing weights.* The maximum landing weights shall be established at which compliance is shown with the generally applicable provisions of this regulation and with the landing and take-off climb provisions prescribed in sections 4T.119 and 4T.120 for altitudes and ambient temperatures within the operational limits of the airplane (see subparagraph (4) of this paragraph).

(3) *Accelerate-stop distance, take-off distance, and take-off run.* The minimum distances required for take-off shall be established at which compliance is shown with the generally applicable provisions of this regulation and with sections 4T.115 and 4T.117(a), and with 4T.117(b) if the take-off distance is intended to include a clearway, for weights, altitudes, temperatures, wind components, and runway gradients, within the operational limits of the airplane (see subparagraph (4) of this paragraph).

(4) *Operational limits.* The operational limits of the airplane shall be established by the applicant for all variable factors required in showing compliance with this regulation (weight, altitude, temperature, etc.). (See secs. 4T.113 (a)(1) and (b), 4T.118, 4T.121, and 4T.122.)

(b) *Information.* The performance information on the operation of the airplane shall be scheduled in compliance with the generally applicable provisions of this regulation and with sections 4T.117a(b), 4T.121, and 4T.122 for weights, altitudes, temperatures, wind components, and runway gradients, as these may be applicable, within the operational limits of the airplane (see subparagraph (a)(4) of this section). In addition, the



performance information specified in subparagraphs (1) through (3) of this paragraph shall be determined by extrapolation and scheduled for the ranges of weights between the maximum landing and maximum take-off weights established in accordance with subparagraphs (a)(1) and (a)(2) of this section. (See also sec. 4T.743.)

- (1) Climb in the landing configuration (see sec. 4T.119);
- (2) Climb in the approach configuration (see sec. 4T.120(d));
- (3) Landing distance (see sec. 4T.122).

### AIRPLANE FLIGHT MANUAL

**4T.743** *Performance limitations, information, and other data.*

(a) *Limitations.* The airplane's performance limitations shall be given in accordance with section 4T.123(a).

(b) *Information.* The performance information prescribed in section 4T.123(b) for the application of the operating rules of this regulation shall be given together with descriptions of the conditions, air speeds, etc., under which the data were determined.

(c) *Procedures.* Procedures established in accordance with section 4T.111(c) shall be given to the extent such procedures are related to the limitations and information set forth in accordance with paragraphs (a) and (b) of this section. Such procedures, in the form of guidance material, shall be included with the relevant limitations or information, as applicable.

(d) *Miscellaneous.* An explanation shall be given of significant or unusual flight or ground handling characteristics of the airplane.

3. In lieu of sections 40.70 through 40.78, 41.27 through 41.36(d), and 42.70 through 42.83, of Parts 40, 41, and 42 of the Civil Air Regulations, respectively, the following shall be applicable:

### OPERATING RULES

**40T.80** *Transport category airplane operating limitations.*

(a) In operating any passenger-carrying transport category airplane certificated in accordance with the performance requirements of this regulation, the provisions of sections 40T.80 through 40T.84 shall be complied with, unless deviations therefrom are specifically authorized by the Administrator on the ground that the special circumstances of a particular case make a literal observance of the requirements unnecessary for safety.

(b) The performance data in the Airplane Flight Manual shall be applied in determining compliance with the provisions of sections 40T.81 through 40T.84. Where conditions differ from those for which specific tests were made, compliance shall be determined by approved interpolation or computation of the effects of changes in the specific variables if such interpolations or computations give results substantially equalling in accuracy the results of a direct test.

**40T.81** *Airplane's certificate limitations.*

(a) No airplane shall be taken off at a weight which exceeds the take-off weight specified in the Airplane Flight Manual for the elevation of the airport and for the ambient temperature existing at the time of the take-off. (See secs. 4T.123(a)(1) and 4T.743(a).)

(b) No airplane shall be taken off at a weight such that, allowing for normal consumption of fuel and oil in flight to the airport of destination and to the alternate airports, the weight on arrival will exceed the landing weight specified in the Airplane Flight Manual for the elevation of each of the airports involved and for the ambient temperatures anticipated at the time of landing. (See secs. 4T.123(a)(2) and 4T.743(a).)

(c) No airplane shall be taken off at a weight which exceeds the weight shown in the Airplane Flight Manual to correspond with the minimum distances required for take-off. These distances shall correspond with the elevation of the airport, the runway to be used, the effective runway gradient, and the ambient temperature and wind component existing at the time of take-off. (See secs. 4T.123(a)(3) and 4T.743(a).) If the take-off distance includes a clearway as defined in Item 5 of this regulation, the take-off distance shall not include a clearway distance greater than one-half of the take-off run.

(d) No airplane shall be operated outside the operational limits specified in the Airplane Flight Manual. (See secs. 4T.123(a)(4) and 4T.743(a).)

**40T.82 Take-off obstacle clearance limitations.** No airplane shall be taken off at a weight in excess of that shown in the Airplane Flight Manual to correspond with a net take-off flight path which clears all obstacles either by at least a height of 35 feet vertically or by at least 200 feet horizontally within the airport boundaries and by at least 300 feet horizontally after passing beyond the boundaries. In determining the allowable deviation of the flight path in order to avoid obstacles by at least the distances prescribed, it shall be assumed that the airplane is not banked before reaching a height of 50 feet as shown by the take-off path data in the Airplane Flight Manual, and that a maximum bank thereafter does not exceed 15 degrees. The take-off path considered shall be for the elevation of the airport, the effective runway gradient, and for the ambient temperature and wind component existing at the time of take-off. (See secs. 4T.123(b) and 4T.743(b).)

**40T.83 En route limitations.**

(a) **One engine inoperative.** No airplane shall be taken off at a weight in excess of that which, according to the one-engine-inoperative en route net flight path data shown in the Airplane Flight Manual, will permit compliance with either subparagraph (1) or subparagraph (2) of this paragraph at all points along the route. The net flight path used shall be for the ambient temperatures anticipated along the route. (See secs. 4T.123(b) and 4T.743(b).)

(1) The slope of the net flight path shall be positive at an altitude of at least 1,000 feet above all terrain and obstructions along the route within 5 miles on either side of the intended track.

(2) The net flight path shall be such as to permit the airplane to continue flight from the cruising altitude to an alternate airport where a landing can be made in accordance with the provisions of section 40T.84(b), the net flight path clearing vertically by at least 2,000 feet all terrain and obstructions along the route within 5 miles on either side of the intended track. The provisions of subdivisions (i) through (vii) of this subparagraph shall apply.

(i) The engine shall be assumed to fail at the most critical point along the route.

(ii) The airplane shall be assumed to pass over the critical obstruction following engine failure at a point no closer to the critical obstruction than the nearest approved radio navigational fix, except that the Administrator may authorize a procedure established on a different basis where adequate operational safeguards are found to exist.

(iii) The net flight path shall have a positive slope at 1,500 feet above the airport used as the alternate.

(iv) An approved method shall be used to account for winds which would otherwise adversely affect the flight path.

(v) Fuel jettisoning shall be permitted if the Administrator finds that the operator has an adequate training program, proper instructions are given to the flight crew, and all other precautions are taken to insure a safe procedure.

(vi) The alternate airport shall be specified in the dispatch release and shall meet the prescribed weather minima.

(vii) The consumption of fuel and oil after the engine becomes inoperative shall be that which is accounted for in the net flight path data shown in the Airplane Flight Manual.

(b) *Two engines inoperative.* No airplane shall be flown along an intended route except in compliance with either subparagraph (1) or subparagraph (2) of this paragraph.

(1) No place along the intended track shall be more than 90 minutes away from an airport at which a landing can be made in accordance with the provisions of section 40T.84(b), assuming all engines to be operating at cruising power.

(2) No airplane shall be taken off at a weight in excess of that which, according to the two-engine-inoperative en route net flight path data shown in the Airplane Flight Manual, will permit the airplane to continue flight from the point where two engines are assumed to fail simultaneously to an airport where a landing can be made in accordance with the provisions of section 40T.84(b), the net flight path having a positive slope at an altitude of at least 1,000 feet above all terrain and obstructions along the route within 5 miles on either side of the intended track or at an altitude of 2,000 feet, whichever is higher. The net flight path considered shall be for the ambient temperatures anticipated along the route. The provisions of subdivisions (i) through (iii) of this subparagraph shall apply. (See secs. 4T.123(b) and 4T.743(b).)

(i) The two engines shall be assumed to fail at the most critical point along the route.

(ii) The airplane's weight at the point where the two engines are assumed to fail shall be considered to be not less than that which would include sufficient fuel to proceed to the airport and to arrive there at an altitude of at least 1,500 feet directly over the landing area and thereafter to fly for 15 minutes at cruise power and/or thrust.

(iii) The consumption of fuel and oil after the engines become inoperative shall be that which is accounted for in the net flight path data shown in the Airplane Flight Manual.

40T.84 *Landing limitations.*

(a) *Airport of destination.* No airplane shall be taken off at a weight in excess of that which, in accordance with the landing distances shown in the Airplane Flight Manual for the elevation of the airport of intended destination and for the wind conditions anticipated there at the time of landing, would permit the airplane to be brought to rest at the airport of intended destination within 60 percent of the effective length of the runway from a point 50 feet directly above the intersection of the obstruction clearance plane and the runway. The weight of the airplane shall be assumed to be reduced by the weight of the fuel and oil expected to be consumed in flight to the airport of intended destination. Compliance shall be shown with the conditions of subparagraphs (1) and (2) of this paragraph. (See secs. 4T.123(b) and 4T.743(b).)

(1) It shall be assumed that the airplane is landed on the most favorable runway and direction in still air.

(2) It shall be assumed that the airplane is landed on the most suitable runway considering the probable wind velocity and direction and taking due account of the ground handling characteristics of the airplane and of other conditions (i.e., landing aids, terrain, etc.). If full compliance with the provisions of this subparagraph is not shown, the airplane may be taken off if an alternate airport is designated which permits compliance with paragraph (b) of this section.

(b) *Alternate airport.* No airport shall be designated as an alternate airport in a dispatch release unless the airplane at the weight anticipated at the time of arrival at such airport can comply with the provisions of paragraph (a) of this section, provided that the airplane can be brought to rest within 70 percent of the effective length of the runway.

4. In lieu of section 43.11 of Part 43 of the Civil Air Regulations, the following shall be applicable:

43T.11 *Transport category airplane weight limitations.* The performance data in the Airplane Flight Manual shall be applied in determining compliance with the following provisions:

(a) No airplane shall be taken off at a weight which exceeds the take-off weight specified in the Airplane Flight Manual for the elevation of the airport and for the ambient temperature existing at the time of the take-off. (See secs. 4T.123(a)(1) and 4T.743(a).)

(b) No airplane shall be taken off at a weight such that, allowing for normal consumption of fuel and oil in flight to the airport of destination and to the alternate airports, the weight on arrival will exceed the landing weight specified in the Airplane Flight Manual for the elevation of each of the airports involved and for the ambient temperatures anticipated at the time of landing. (See secs. 4T.123(a)(2) and 4T.743(a).)

(c) No airplane shall be taken off at a weight which exceeds the weight shown in the Airplane Flight Manual to correspond with the minimum distances required for take-off. These distances shall correspond with the elevation of the airport, the runway to be used, the effective runway gradient, and the ambient temperature and wind component existing at the time of take-off. (See secs. 4T.123(a)(3) and 4T.743(a).) If the take-off distance includes a clearway as defined in Item 5 of this regulation, the take-off distance shall not include a clearway distance greater than one-half of the take-off run.

(d) No airplane shall be operated outside the operational limits specified in the Airplane Flight Manual. (See secs. 4T.123(a)(4) and 4T.743(a).)

5. The following definitions shall apply:

*Clearway.* A clearway is an area beyond the airport runway not less than 300 feet on either side of the extended center line of the runway, at an elevation no higher than the elevation at the end of the runway, clear of all fixed obstacles, and under the control of the airport authorities.

## SPECIAL CIVIL AIR REGULATION NO. SR-422B

(As amended by Amendment No. 1, issued Dec. 10, 1962, effective Jan. 15, 1963, published in 27 F.R. 12399, Dec. 14, 1962, and Amendment No. 2, issued Dec. 20, 1962, effective Dec. 20, 1962, published in 27 F.R. 12926, Dec. 29, 1962.)

Effective: July 9, 1959  
Issued: July 9, 1959

Published: July 14, 1959  
(24 F.R. 5629)

Corrected: July 14, 1959  
(24 F.R. 5688)

### Turbine-Powered Transport Category Airplane of Current Design

Special Civil Air Regulation No. SR-422, effective August 27, 1957, prescribes requirements applicable to the type certification and operation of turbine-powered transport category airplanes for which a type certificate is issued after August 27, 1957. Special Civil Air Regulation No. SR-422A, effective July 2, 1958, included substantive changes to SR-422 and was made applicable to all turbine-powered transport category airplanes for which a type certificate is issued after September 30, 1958.

This Special Civil Air Regulation makes further changes to the airworthiness rules for turbine-powered transport category airplanes to be applicable to all such airplanes for which a type certificate is issued after August 29, 1959. These changes were proposed in Draft Release No. 58-1C (24 F.R. 128) by the Civil Aeronautics Board in connection with the 1958 Annual Airworthiness Review. The amendments herein have been adopted after careful consideration of all the discussion and comment received thereon.

Substantive and minor changes have been made to the provisions of SR-422A. For ease in identification they are listed as follows:

(a) Substantive changes: introductory paragraphs; 4T.114 (b), (c), (d), (e), and (f); 4T.115(d); 4T.117a(b); 4T.120 (a)(3), (b), and (d); 40T.81(c); 43T.11(c); and item 5 (a) and (b).

(b) Minor changes; item 2; 4T.112 (title), (b)(1), (c), (d), and (e); 4T.113(b); 4T.116(i)(4); 4T.117(b) (1) and (2); 4T.120(a); 4T.121; 4T.122(d); 4T.123(a); 40T.82; and 40T.83.

Pertinent background information to this regulation is contained in the preambles to SR-422 and SR-422A. Following is a discussion of important issues relevant to the changed provisions contained herein.

One of the most important changes being introduced concerns the rotation speed  $V_R$  of the airplane during takeoff (4T.114). Experience gained in the certification of airplanes under the provisions of SR-422 and SR-422A indicates that relating  $V_R$  to the stall speed is not essential and might unduly penalize airplanes with superior flying qualities. It has been found that the primary limitations on  $V_R$  should be in terms of a margin between the actual lift-off speeds  $V_{LOF}$  and the minimum unstick speed  $V_{MU}$  at which the airplane can proceed safely with the takeoff. The provisions contained herein require that  $V_R$  speeds be established to be

applicable to takeoffs with one engine inoperative as well as with all engines operating. The  $V_{MU}$  speeds can be established from free air data provided that the data are verified by ground takeoff tests. Certain safeguards are included in conjunction with the establishment of  $V_R$  speeds to ensure that takeoffs in service can be made with consistent safety.

A change is being introduced to the provision in 4T.117a(b) concerning the manner in which the net takeoff flight path is obtained. In accordance with this provision as contained in SR-422A, the net takeoff flight path would have a negative slope throughout the acceleration segment. Since this segment usually represents level flight easily controlled by reference to the normal flight instruments, a significant reduction in the flight path's gradient would not be expected. For these reasons, the provision is being changed to permit an equivalent reduction in acceleration in lieu of a reduction in gradient.

Section 4T.117a(b) is being amended additionally by changing the value of gradient margin in the net flight path for two-engine airplanes from 1.0 percent to 0.8 percent. The value for four-engine airplanes remains 1.0 percent. Differentiation in gradient values in the net flight path between two and four-engine airplanes is consistent with the differentiation in the climb gradients for the takeoff, enroute, and approach stages of flight. Statistical analysis substantiates the specific reduction of the net flight path gradient to a value of 0.8 percent. Correlatively, a re-evaluation of the climb gradients for twin-engine airplanes in the second segment takeoff and in the approach climb indicates that the respective values should be 2.4 percent and 2.1 percent and these changes are being made in 4T.120 (b) and (d).

A change is introduced in the conditions prescribed for meeting the climb gradient in the first segment takeoff climb (4T.120(a)), by changing the speed  $V_2$  to the speed  $V_{LOF}$ . The intent of this requirement is to use the speed at which the airplane lifts off the ground. In SR-422 this speed was considered to be  $V_2$ ; however, in SR-422A and in this regulation the speed  $V_2$  is a higher speed which is reached at the end of the takeoff distance and no longer reflects the conditions pertinent to the first segment climb. In making this change consistent with relevant changes in SR-422A and in this regulation, no consideration has been given to the appropriateness of the minimum climb gradient values prescribed for the first segment climb. These are subject to alteration if results of further studies so indicate.

There is being introduced in this regulation the concept of "stopways," the definition of which is contained in item 5(b). Stopways have been used outside the United States in meeting the accelerate-stop distances in case of aborted takeoffs. They are considered to result in more practical operations. In order to ensure that they can be used without detrimental effects on safety, a provision is being included in 4T.115(d) requiring taking into account the surface characteristics of the stopways to be used in scheduling the accelerate-stop distances in the Airplane Flight Manual.

In conjunction with the introduction of stopways, there are changes being made in the definition of a "clearway" (item 5(a)). One of the changes is to specify that a clearway begins at the end of the runway whether or not a stopway is being used. Of the other changes, the most

significant one expresses the clearway in terms of a clearway plane and permits this plane to have an upward slope of 1.25 percent. In effect, this change will allow, in some cases, use of clearways which would not be allowed under the definition in SR-422A because of relatively small obstacles or slightly sloping terrain. (See also 40T.81(c) and 43T.11(c).)

There are also included in this regulation a number of minor, editorial, or clarifying changes.

Draft Release No. 58-1C included a proposal for expanding lateral obstacle clearances in the takeoff flight path. Studies indicate that some expanding lateral clearances are necessary for safety in operations with all turbine-powered airplanes. It appears, therefore, that an appropriate rule should be made applicable not only to airplanes certificated in accordance with this regulation, but also to those certificated in accordance with SR-422 and SR-422A. Accordingly, no change is being made in this regulation to the lateral obstacle clearance provisions, instead, a Notice of Proposed Rule Making is now being prepared to amend SR-422, SR-422A, and this regulation, to require expanding lateral obstacle clearances for all airplanes certificated thereunder.

This Special Civil Air Regulation is not intended to compromise the authority of the Administrator under section 4b.10 to impose such special conditions as are found necessary in any particular case to avoid unsafe design features and otherwise to ensure equivalent safety.

Interested persons have been afforded an opportunity to participate in the making of this regulation (24 F.R. 128), and due consideration has been given to all relevant matter presented.

This regulation does not require compliance until after August 29, 1959; however, since applicants for a type certificate for turbine-powered transport category airplanes may elect to show compliance with this regulation before that date, it is being made effective immediately.

In consideration of the foregoing, the following Special Civil Air Regulation is hereby promulgated to become effective immediately:

**[Contrary provisions of the Civil Air Regulations notwithstanding, all turbine-powered transport category airplanes for which a type certificate is issued after August 29, 1959, shall comply with all of the following requirements, except that, turbopropeller-powered airplanes previously type certificated with the same number of reciprocating engines need only comply with the performance requirements of paragraph 2.]** Applicants for a type certificate for a turbine-powered transport category airplane may elect and are authorized to meet the requirements of this Special Civil Air Regulation prior to August 29, 1959, in which case however, all of the following provisions must be complied with.

1. The provisions of Part 4b of the Civil Air Regulations, effective on the date of application for type certificate; and such of the provisions of all subsequent amendments to Part 4b, in effect prior to August 27, 1957, as the Administrator finds necessary to ensure that the level of safety of turbine-powered airplanes is equivalent to that generally intended by Part 4b.

2. In lieu of sections 4b.110 through 4b.125, 4b.183, and 4b.743 of Part 4b of the Civil Air Regulations, the following shall be applicable:



**PERFORMANCE****4T.110 General.**

(a) The performance of the airplane shall be determined and scheduled in accordance with, and shall meet the minima prescribed by, the provision of sections 4T.110 through 4T.123. The performance limitations, information, and other data shall be given in accordance with section 4T.743.

(b) Unless otherwise specifically prescribed, the performance shall correspond with ambient atmospheric conditions and still air. Humidity shall be accounted for as specified in paragraph (c) of this section.

(c) The performance as affected by engine power and/or thrust shall be based on a relative humidity of 80 percent at and below standard temperatures and on 34 percent at and above standard temperatures plus 50° F. Between these two temperatures the relative humidity shall vary linearly.

(d) The performance shall correspond with the propulsive thrust available under the particular ambient atmospheric conditions, the particular flight condition, and the relative humidity specified in paragraph (c) of this section. The available propulsive thrust shall correspond with engine power and/or thrust not exceeding the approved power and/or thrust less the installational losses and less the power and/or equivalent thrust absorbed by the accessories and services appropriate to the particular ambient atmospheric conditions and the particular flight condition.

**4T.111 Airplane configuration, speed, power, and/or thrust; general.**

(a) The airplane configuration (setting of wing and cowl flaps, air brakes, landing gear, propeller, etc.), denoted respectively as the take-off, en route, approach, and landing configurations, shall be selected by the applicant except as otherwise prescribed.

(b) It shall be acceptable to make the airplane configurations variable with weight, altitude, and temperature, to an extent found by the Administrator to be compatible with operating procedures required in accordance with paragraph (c) of this section.

(c) In determining the accelerate-stop distances, takeoff flight paths, takeoff distances, and landing distances, changes in the airplane's configuration and speed, and in the power and thrust shall be in accordance with procedures established by the applicant for the operation of the airplane in service, except as otherwise prescribed. In addition, procedures shall be established for the execution of balked landings and missed approaches associated with the conditions prescribed in sections 4T.119 and 4T.120(d), respectively. All procedures shall comply with the provisions of subparagraphs (1) through (3) of this paragraph.

(1) The Administrator shall find that the procedures can be consistently executed in service by crews of average skill.

(2) The procedures shall not involve methods or the use of devices which have not been proven to be safe and reliable.

(3) Allowance shall be made for such time delays in the execution of the procedures as may be reasonably expected to occur during service.

**4T.112 Stalling and minimum control speeds.**

(a) The speed  $V_s$  shall denote the calibrated stalling speed, or the minimum steady flight speed at which the airplane is controllable, in knots, with:

(1) Zero thrust at the stalling speed, or engines idling and throttles closed if it is shown that the resultant thrust has no appreciable effect on the stalling speed;

(2) If applicable, propeller pitch controls in the position necessary for compliance with subparagraph (1) of this paragraph; the airplane in all other respects (flaps, landing gear, etc.) in the particular configuration corresponding with that in connection with which  $V_s$  is being used;

(3) The weight of the airplane equal to the weight in connection with which  $V_s$  is being used to determine compliance with a particular requirement;

(4) The center of gravity in the most unfavorable position within the allowable range.

(b) The stall speed defined in this section shall be the minimum speed obtained in flight tests conducted in accordance with the procedure of subparagraphs (1) and (2) of this paragraph.

(1) With the airplane trimmed for straight flight at a speed chosen by the applicant, but not less than  $1.2 V_s$ , nor greater than  $1.4 V_s$ , and from a speed sufficiently above the stalling speed to ensure steady conditions, the elevator control shall be applied at a rate such that the airplane speed reduction does not exceed 1 knot per second.

(2) During the test prescribed in subparagraph (1) of this paragraph, the flight characteristics provisions of section 4b.160 of Part 4b of the Civil Air Regulations shall be complied with.

(c) The minimum control speed  $V_{MC}$ , in terms of calibrated air speed, shall be determined under the conditions specified in this paragraph so that, when the critical engine is suddenly made inoperative at that speed, it is possible to recover control of the airplane with the engine still inoperative and to maintain it in straight flight at that speed, either with zero yaw or, at the option of the applicant, with an angle of bank not in excess of 5 degrees.  $V_{MC}$  shall not exceed  $1.2 V_s$  with:

(1) Engines operating at the maximum available takeoff thrust and/or power;

(2) Maximum sea level takeoff weight or such lesser weight as might be necessary to demonstrate  $V_{MC}$ .

(3) The airplane in the most critical takeoff configuration existing along the flight path after the airplane becomes airborne, except that the landing gear is retracted;

(4) The airplane trimmed for takeoff;

(5) The airplane airborne and the ground effect negligible;

(6) The center of gravity in the most unfavorable position;

(d) In demonstrating the minimum speed specified in paragraph (c) of this section, the rudder force required to maintain control shall not exceed 180 pounds and it shall not be necessary to reduce the power and/or thrust of the operative engine(s).

(e) During recovery from the maneuver specified in paragraph (c) of this section, the airplane shall not assume any dangerous attitude, nor shall it require exceptional skill, strength, or alertness on the part of the pilot to prevent a change of heading in excess of 20 degrees before recovery is complete.

**4T.113 Takeoff; general.**

(a) The takeoff data in sections 4T.114 through 4T.117 shall be determined under the conditions of subparagraphs (1) and (2) of this paragraph.

(1) At all weights, altitudes, and ambient temperatures, within the operational limits established by the applicant for the airplane.

(2) In the configuration for takeoff (see sec. 4T.111).

(b) Takeoff data shall be based on a smooth, dry, hard-surfaced runway and shall be determined in such a manner that reproduction of the performance does not require exceptional skill or alertness on the part of the pilot. In the case of seaplanes or float planes, the takeoff surface shall be smooth water, while for skiplane it shall be smooth, dry snow. In addition, the takeoff data shall include operational correction factors in accordance with subparagraphs (1) and (2) of this paragraph for wind and for runway gradients, within the operational limits established by the applicant for the airplane.

(1) Not more than 50 percent of nominal wind components along the takeoff path opposite to the direction of takeoff, and not less than 150 percent of nominal wind components along the takeoff path in the direction of takeoff.

(2) Effective runway gradients.

**4T.114 Takeoff speeds.**

(a) The critical-engine-failure speed  $V_1$  in terms of calibrated air speed, shall be selected by the applicant, but shall not be less than the minimum speed at which controllability by primary aerodynamic controls alone is demonstrated during the takeoff run to be adequate to permit proceeding safely with the takeoff using average piloting skill, when the critical engine is suddenly made inoperative.

(b) The minimum takeoff safety speed  $V_{2min}$ , in terms of calibrated air speed, shall not be less than:

(1)  $1.2 V_s$  for two-engine [and three-engine] propeller-driven airplanes and for airplanes without propellers which have no provisions for obtaining a significant reduction in the one-engine-inoperative power-on stalling speed;

(2)  $1.15 V_s$  for propeller-driven airplanes having more than [three] engines and for airplanes without propellers which have provisions for obtaining a significant reduction in the one-engine-inoperative power-on stalling speed;

(3) 1.10 times the minimum control speed  $V_{MC}$ .

(c) The takeoff safety speed  $V_2$ , in terms of calibrated air speed, shall be selected by the applicant so as to permit the gradient of climb required in section 4T.120(b), but it shall not be less than:

(1) The speed  $V_{2\ min}$ ,

(2) The rotation speed  $V_R$  (see paragraph (e) of this section) plus the increment in speed attained prior to reaching a height of 35 feet above the takeoff surface in compliance with section 4T.116(e).

(d) The minimum unstick speed  $V_{MU}$ , in terms of calibrated air speed, shall be the speed at and above which the airplane can be made to lift off the ground and to continue the takeoff without displaying any hazardous characteristics.  $V_{MU}$  speeds shall be selected by the applicant for the all-engines-operating and the one-engine-inoperative conditions. It shall be acceptable to establish the  $V_{MU}$  speeds from free air data: *Provided*, That these data are verified by ground takeoff tests.

NOTE: In certain cases, ground takeoff tests might involve some takeoffs at the  $V_{MU}$  speeds.

(e) The rotation speed  $V_R$ , in terms of calibrated air speed, shall be selected by the applicant in compliance with the conditions of subparagraphs (1) through (4) of this paragraph.

(1) The  $V_R$  speed shall not be less than:

(i) The speed  $V_1$ ;

(ii) A speed equal to 105 percent of  $V_{MC}$ ;

(iii) A speed which permits the attainment of the speed  $V_2$  prior to reaching a height of 35 feet above the takeoff surface as determined in accordance with section 4T.116(e);

(iv) A speed which, if the airplane is rotated at its maximum practicable rate, will result in a lift-off speed  $V_{LOF}$  (see paragraph (f) of this section) not less than 110 percent of  $V_{MU}$  in the all-engines-operating condition nor less than 105 percent of  $V_{MC}$  in the one-engine-inoperative condition.

(2) For any given set of conditions (weight, configuration, temperature, etc.), a single value of  $V_R$  speed obtained in accordance with this paragraph shall be used in showing compliance with both the one-engine-inoperative and the all-engines-operating takeoff provisions.

(3) It shall be shown that the one-engine-inoperative takeoff distance determined with a rotation speed 5 knots less than the  $V_R$  speed established in accordance with subparagraphs (1) and (2) of this paragraph does not exceed the corresponding one-engine-inoperative takeoff distance determined with the established  $V_R$  speed. The determination of the takeoff distances shall be in accordance with section 4T.117(a)(1).

(4) It shall be demonstrated that reasonably expected variations in service from the takeoff procedures established by the applicant for the operation of the airplane (see sec. 4T.111(c)) (e.g., over-rotation of the airplane, out of trim conditions) will not result in unsafe flight characteristics nor in marked increases in the scheduled takeoff distances established in accordance with section 4T.117(a).

(f) The lift-off speed  $V_{LOF}$ , in terms of calibrated air speed, shall be the speed at which the airplane first becomes airborne.

4T.115 *Accelerate-stop distance.*

(a) The accelerate-stop distance shall be the sum of the following:

(1) The distance required to accelerate the airplane from a standing start to the speed  $V_1$ ;

(2) Assuming the critical engine to fail at the speed  $V_1$ , the distance required to bring the airplane to a full stop from the point corresponding with the speed  $V_1$ .

(b) In addition to, or in lieu of, wheel brakes, the use of other braking means shall be acceptable in determining the accelerate-stop distance, provided that such braking means shall have been proven to be safe and reliable, that the manner of their employment is such that consistent results can be expected in service and that exceptional skill is not required to control the airplane.

(c) The landing gear shall remain extended throughout the accelerate-stop distance.

(d) If the accelerate-stop distance is intended to include a stopway with surface characteristics substantially different from those of a smooth hard-surfaced runway, the takeoff data shall include operational correction factors for the accelerate-stop distance to account for the particular surface characteristics of the stopway and the variations in such characteristics with seasonal weather conditions (i.e., temperature, rain, snow, ice, etc.), within the operational limits established by the applicant.

**4T.116 Takeoff path.** The takeoff path shall be considered to extend from the standing start to a point in the takeoff where a height of 1,500 feet above the takeoff surface is reached or to a point in the takeoff where the transition from the takeoff to the en route configuration is completed and a speed is reached at which compliance with section 4T.120(c) is shown, whichever point is at a higher altitude. The conditions of paragraphs (a) through (i) of this section shall apply in determining the takeoff path.

(a) The takeoff path shall be based upon procedures prescribed in accordance with section 4T.111(c).

(b) The airplane shall be accelerated on the ground to the speed  $V_1$  at which point the critical engine shall be made inoperative and shall remain inoperative during the remainder of the takeoff. Subsequent to attaining speed  $V_1$ , the airplane shall be accelerated to speed  $V_2$  during which time it shall be permissible to initiate raising the nose gear off the ground at a speed not less than the rotating speed  $V_R$ .

(c) Landing gear retraction shall not be initiated until the airplane becomes airborne.

(d) The slope of the airborne portion of the takeoff path shall be positive at all points.

(e) The airplane shall attain the speed  $V_2$  prior to reaching a height of 35 feet above the takeoff surface and shall continue at a speed as close as practical to, but not less than,  $V_2$  until a height of 400 feet above the takeoff surface is reached.

(f) Except for gear retraction and propeller feathering, the airplane configuration shall not be changed before reaching a height of 400 feet above the takeoff surface.

(g) At all points along the takeoff path starting at the point where the airplane first reaches a height of 400 feet above the takeoff surface, the available gradient of climb shall not be less than 1.2 percent

for two-engine airplanes, [1.5 percent for three-engine airplanes,] and 1.7 percent for four-engine airplanes.

(h) The takeoff path shall be determined either by a continuous demonstrated takeoff, or alternatively, by synthesizing from segments the complete takeoff path.

(i) If the takeoff path is determined by the segmental method, the provisions of subparagraphs (1) through (4) of this paragraph shall be specifically applicable.

(1) The segments of a segmental takeoff path shall be clearly defined and shall be related to the distinct changes in the configuration of the airplane, in power and/or thrust, and in speed.

(2) The weight of the airplane, the configuration, and the power and/or thrust shall be constant throughout each segment and shall correspond with the most critical condition prevailing in the particular segment.

(3) The segmental flight path shall be based on the airplane's performance without ground effect.

(4) Segmental takeoff path data shall be checked by continuous demonstrated takeoffs up to the point where the airplane's performance is out of ground effect and the airplane's speed is stabilized, to ensure that the segmental path is conservative relative to the continuous path.

NOTE: The airplane usually is considered out of ground effect when it reaches a height above the ground equal to the airplane's wing span.

#### 4T.117 *Takeoff distance and takeoff run.*

(a) *Takeoff distance.* The takeoff distance shall be the greater of the distances established in accordance with subparagraphs (1) and (2) of this paragraph.

(1) The horizontal distance along the takeoff path from the start of the takeoff to the point where the airplane attains a height of 35 feet above the takeoff surface, as determined in accordance with section 4T.116.

(2) A distance equal to 115 percent of the horizontal distance along the takeoff path, with all engines operating, from the start of the takeoff to the point where the airplane attains a height of 35 feet above the takeoff surface, as determined by a procedure consistent with that established in accordance with section 4T.116.

(b) *Takeoff run.* If the takeoff distance is intended to include a clearway (see item 5 of this regulation), the takeoff run shall be determined and shall be the greater of the distances established in accordance with subparagraphs (1) and (2) of this paragraph.

(1) The horizontal distance along the takeoff path from the start of the takeoff to a point equidistant between the point where the speed  $V_{LOF}$  is reached and the point where the airplane attains a height of 35 feet above the takeoff surface, as determined in accordance with section 4T.116.

(2) A distance equal to 115 percent of the horizontal distance along the takeoff path, with all engines operating, from the start of the takeoff to a point equidistant between the point where the speed  $V_{LOF}$  is reached and the point where the airplane attains a height of 35 feet above

the takeoff surface, as determined by a procedure consistent with that established in accordance with section 4T.116.

**4T.117a Takeoff flight path.**

(a) The takeoff flight path shall be considered to begin at a height of 35 feet above the takeoff surface at the end of the takeoff distance as determined in accordance with section 4T.117(a).

(b) The net takeoff flight path data shall be determined in such a manner that they represent the airplane's actual takeoff flight paths, determined in accordance with section 4T.116 and with paragraph (a) of this section, reduced at each point by a gradient of climb equal to 0.8 percent for two-engine airplanes, [equal to 0.9 percent for three-engine airplanes,] and equal to 1.0 percent for four-engine airplanes. It shall be acceptable to apply the prescribed reduction in climb gradient as an equivalent reduction in the airplane's acceleration along that portion of the actual takeoff flight path where the airplane is accelerated in level flight.

**4T.118 Climb; general.** Compliance shall be shown with the climb requirements of sections 4T.119 and 4T.120 at all weights, altitudes, and ambient temperatures, within the operational limits established by the applicant for the airplane. The airplane's center of gravity shall be in the most unfavorable position corresponding with the applicable configuration.

**4T.119 All-engine-operating landing climb.** In the landing configuration the steady gradient of climb shall not be less than 3.2 percent, with:

(a) All engines operating at the power and/or thrust which are available 8 seconds after initiation of movement of the power and/or thrust controls from the minimum flight idle to the takeoff position;

(b) A climb speed not in excess of  $1.3 V_s$ .

**4T.120 One-engine-inoperative climb.**

(a) **Takeoff; landing gear extended.** In the critical takeoff configuration existing along the flight path between the points where the airplane reaches the speed  $V_{LOF}$  and where the landing gear is fully retracted, in accordance with section 4T.116 but without ground effect, the steady gradient of climb shall be positive for two-engine airplanes and shall not be less than [0.3 percent for three-engine airplanes, and not less than] 0.5 percent for four-engine airplanes, with:

(1) The critical engine inoperative, the remaining engine(s) operating at the available takeoff power and/or thrust existing in accordance with section 4T.116 at the time retraction of the airplane's landing gear is initiated, unless subsequently a more critical power operating condition exists along the flight path prior to the point where the landing gear is fully retracted;

(2) The weight equal to the airplane's weight existing in accordance with section 4T.116 at the time retraction of the airplane's landing gear is initiated;

(3) The speed equal to the speed  $V_{LOF}$ .

(b) **Takeoff; landing gear retracted.** In the takeoff configuration existing at the point of the flight path where the airplane's landing gear is fully retracted, in accordance with section 4T.116 but without ground effect, the steady gradient of climb shall not be less than 2.4 per-

cent for two-engine airplanes, [not less than 2.7 percent for three-engine airplanes,] and not less than 3.0 percent for four-engine airplanes, with:

(1) The critical engine inoperative, the remaining engine(s) operating at the available takeoff power and/or thrust existing in accordance with section 4T.116 at the time the landing gear is fully retracted, unless subsequently a more critical power operating condition exists along the flight path prior to the point where a height of 400 feet above the takeoff surface is reached;

(2) The weight equal to the airplane's weight existing in accordance with section 4T.116 at the time the airplane's landing gear is fully retracted;

(3) The speed equal to the speed  $V_2$ .

(c) *Final takeoff.* In the en route configuration, the steady gradient of climb shall not be less than 1.2 percent for two-engine airplanes, [not less than 1.5 percent for three-engine airplanes,] and not less than 1.7 percent for four-engine airplanes, at the end of the takeoff path as determined by section 4T.116, with:

(1) The critical engine inoperative, the remaining engine(s) operating at the available maximum continuous power and/or thrust;

(2) The weight equal to the airplane's weight existing in accordance with section 4T.116 at the end of the takeoff path.

(3) The speed equal to not less than  $1.25 V_s$ .

(d) *Approach.* In the approach configuration corresponding with the normal all-engines-operating procedure such that  $V_s$  related to this configuration does not exceed 110 percent of the  $V_s$  corresponding with the related landing configuration, the steady gradient of climb shall not be less than 2.1 percent for two-engine airplanes, [not less than 2.4 percent for three-engine airplanes,] and not less than 2.7 percent for four-engine airplanes with:

(1) The critical engine inoperative, the remaining engine(s) operating at the available takeoff power and/or thrust;

(2) The weight equal to the maximum landing weight;

(3) A climb speed established by the applicant in connection with normal landing procedures, except that it shall not exceed  $1.5 V_s$  (see sec. 4T.111(c)).

**4T.121 En route flight paths.** With the airplane in the en route configuration, the flight paths prescribed in paragraphs (a) and (b) of this section shall be determined at all weights, altitudes, and ambient temperatures, within the operational limits established by the applicant for the airplane.

(a) *One engine inoperative.* The one-engine-inoperative net flight path data shall be determined in such a manner that they represent the airplane's actual climb performance diminished by a gradient of climb equal to 1.1 percent for two-engine airplanes, [1.4 percent for three-engine airplanes,] and 1.6 percent for four-engine airplanes. It shall be acceptable to include in these data the variation of the airplane's weight along the flight path to take into account the progressive consumption of fuel and oil by the operating engine(s).



(b) *Two engines inoperative.* [For airplanes with three or four engines, the two-engine-inoperative net flight path data shall be determined in such a manner that they represent the airplane's actual climb performance diminished by a gradient of climb equal to 0.3 percent for three-engine airplanes and equal to 0.5 percent for four-engine airplanes.] It shall be acceptable to include in these data the variation of the airplane's weight along the flight path to take into account the progressive consumption of fuel and oil by the operating engines.

(c) *Conditions.* In determining the flight paths prescribed in paragraphs (a) and (b) of this section, the conditions of subparagraphs (1) through (4) of this paragraph shall apply.

(1) The airplane's center of gravity shall be in the most unfavorable position.

(2) The critical engine(s) shall be inoperative, the remaining engine(s) operating at the available maximum continuous power and/or thrust.

(3) Means for controlling the engine cooling air supply shall be in the position which provides adequate cooling in the hot-day condition.

(4) The speed shall be selected by the applicant.

4T.122 *Landing distance.* The landing distance shall be the horizontal distance required to land and to come to a complete stop (to a speed of approximately 3 knots in the case of seaplanes or float planes) from a point at a height of 50 feet above the landing surface. Landing distances shall be determined for standard temperatures at all weights, altitudes, and winds, within the operational limits established by the applicant for the airplane. The conditions of paragraphs (a) through (g) of this section shall apply.

(a) The airplane shall be in the landing configuration. During the landing, changes in the airplane's configuration, in power and/or thrust, and in speed shall be in accordance with procedures established by the applicant for the operation of the airplane in service. The procedures shall comply with the provisions of section 4T.111(c).

(b) The landing shall be preceded by a steady gliding approach down to the 50-foot height with a calibrated air speed of not less than  $1.3 V_r$ .

(c) The landing distance shall be based on a smooth, dry, hard-surfaced runway, and shall be determined in such a manner that reproduction does not require exceptional skill or alertness on the part of the pilot. In the case of seaplanes or float planes, the landing surface shall be smooth water, while for skiplanes it shall be smooth, dry snow. During landing, the airplane shall not exhibit excessive vertical acceleration, a tendency to bounce, nose over, ground loop, porpoise, or water loop.

(d) The landing distance data shall include operational correction factors for not more than 50 percent of nominal wind components along the landing path opposite to the direction of landing and not less than 150 percent of nominal wind components along the landing path in the direction of landing.

(e) During landing, the operating pressures on the wheel braking system shall not be in excess of those approved by the manufacturer

of the brakes, and the wheel brakes shall not be used in such a manner as to produce excessive wear of brakes and tires.

(f) In addition to, or in lieu of, wheel brakes, the use of other braking means shall be acceptable in determining the landing distance, provided such braking means shall have been proven to be safe and reliable, that the manner of their employment is such that consistent results can be expected in service, and that exceptional skill is not required to control the airplane.

(g) If the characteristics of a device (e.g., the propellers) dependent upon the operation of any of the engines noticeably increase the landing distance when the landing is made with the engine inoperative, the landing distance shall be determined with the critical engine inoperative unless the Administrator finds that the use of compensating means will result in a landing distance not greater than that attained with all engines operating.

**4T.123 *Limitations and information.***

(a) *Limitations.* The performance limitations on the operation of the airplane shall be established in accordance with subparagraph (1) through (4) of this paragraph. (See also sec. 4T.743.)

(1) *Takeoff weights.* The maximum takeoff weights shall be established at which compliance is shown with the generally applicable provisions of this regulation and with the takeoff climb provisions pre-

scribed in section 4T.120 (a), (b), and (c) for altitudes and ambient temperatures, within the operational limits of the airplane (see subparagraph (4) of this paragraph).

(2) *Landing weights.* The maximum landing weights shall be established at which compliance is shown with the generally applicable provisions of this regulation and with the landing and takeoff climb provisions prescribed in sections 4T.119 and 4T.120 for altitudes and ambient temperatures, within the operational limits of the airplane (see subparagraph (4) of this paragraph).

(3) *Accelerate-stop distance, takeoff distance, and takeoff run.* The minimum distances required for takeoff shall be established at which compliance is shown with the generally applicable provisions of this regulation and with sections 4T.115 and 4T.117(a) and with 4T.117(b) if the takeoff distance is intended to include a clearway, for weights, altitudes, temperatures, wind components, and runway gradients, within the operational limits of the airplane (see subparagraph (4) of this paragraph).

(4) *Operational limits.* The operational limits of the airplane shall be established by the applicant for all variable factors required in showing compliance with this regulation (weight, altitude, temperature, etc.). (See secs. 4T.113 (a)(1) and (b), 4T.115(d), 4T.118, 4T.121, and 4T.122.)

(b) *Information.* The performance information on the operation of the airplane shall be scheduled in compliance with the generally applicable provisions of this regulation and with sections 4T.117a(b), 4T.121, and 4T.122 for weights, altitudes, temperatures, wind components, and runway gradients, as these may be applicable, within the operational limits of the airplane (see subparagraph (a)(4) of this section). In addition, the performance information specified in subparagraphs (1) through (3) of this paragraph shall be determined by extrapolation and scheduled for the ranges of weights between the maximum landing and maximum takeoff weights established in accordance with subparagraphs (a)(1) and (a)(2) of this section. (See also sec. 4T.743.)

- (1) Climb in the landing configuration (see sec. 4T.119);
- (2) Climb in the approach configuration (see sec. 4T.120(d));
- (3) Landing distance (see sec. 4T.122).

## AIRPLANE FLIGHT MANUAL

### 4T.743 *Performance limitations, information, and other data.*

(a) *Limitations.* The airplane's performance limitations shall be given in accordance with section 4T.123(a).

(b) *Information.* The performance information prescribed in section 4T.123(b) for the application of the operating rules of this regulation shall be given together with descriptions of the conditions, air speeds, etc., under which the data were determined.

(c) *Procedures.* Procedures established in accordance with section 4T.111(c) shall be given to the extent such procedures are related to the limitations and information set forth in accordance with paragraphs (a) and (b) of this section. Such procedures, in the form of

guidance material, shall be included with the relevant limitations or information, as applicable.

(d) *Miscellaneous.* An explanation shall be given of significant or unusual flight or ground handling characteristics of the airplane.

3. In lieu of sections 40.70 through 40.78, 41.27 through 41.36(d), and 42.70 through 42.83, of Parts 40, 41, and 42, respectively, of the Civil Air Regulations, the following shall be applicable:

## OPERATING RULES

### 40T.80 *Transport category airplane operating limitations.*

(a) In operating any passenger-carrying transport category airplane certificated in accordance with the performance requirements of this regulation, the provisions of sections 40T.80 through 40T.84 shall be complied with, unless deviations therefrom are specifically authorized by the Administrator on the ground that the special circumstances of a particular case make a literal observance of the requirements unnecessary for safety.

(b) The performance data in the Airplane Flight Manual shall be applied in determining compliance with the provisions of sections 40T.81 through 40T.84. Where conditions differ from those for which specific tests were made, compliance shall be determined by approved interpolation or computation of the effects of changes in the specific variables if such interpolations or computations give results substantially equalling in accuracy the results of a direct test.

### 40T.81 *Airplane's certificate limitations.*

(a) No airplane shall be taken off at a weight which exceeds the takeoff weight specified in the Airplane Flight Manual for the elevation of the airport and for the ambient temperature existing at the time of the takeoff. (See secs. 4T.123(a)(1) and 4T.743(a).)

(b) No airplane shall be taken off at a weight such that, allowing for normal consumption of fuel and oil in flight to the airport of destination and to the alternate airports, the weight on arrival will exceed the landing weight specified in the Airplane Flight Manual for the elevation of each of the airports involved and for the ambient temperatures anticipated at the time of landing. (See secs. 4T.123(a)(2) and 4T.743(a).)

(c) No airplane shall be taken off at a weight which exceeds the weight at which, in accordance with the minimum distances for takeoff scheduled in the Airplane Flight Manual, compliance with subparagraphs (1) through (3) of this paragraph is shown. These distances shall correspond with the elevation of the airport, the runway to be used, the effective runway gradient, and the ambient temperature and wind component existing at the time of takeoff. (See secs. 4T.123(a)(3) and 4T.743(a).)

(1) The accelerate-stop distance shall not be greater than the length of the runway plus the length of the stopway if present.

(2) The takeoff distance shall not be greater than the length of the runway plus the length of the clearway if present, except that the length of the clearway shall not be greater than one-half of the length of the runway.

(3) The takeoff run shall not be greater than the length of the runway.

(d) No airplane shall be operated outside the operational limits specified in the Airplane Flight Manual. (See secs. 4T.123(a)(4) and 4T.743(a).)

**40T.82 Takeoff obstacle clearance limitations.** No airplane shall be taken off at a weight in excess of that shown in the Airplane Flight Manual to correspond with a net takeoff flight path which clears all obstacles either by at least a height of 35 feet vertically or by at least 200 feet horizontally within the airport boundaries and by at least 300 feet horizontally after passing beyond the boundaries. In determining the allowable deviation of the net takeoff flight path in order to avoid obstacles by at least the distances prescribed, it shall be assumed that the airplane is not banked before reaching a height of 50 feet as shown by the net takeoff flight path data in the Airplane Flight Manual, and that a maximum bank thereafter does not exceed 15 degrees. The net takeoff flight path considered shall be for the elevation of the airport, the effective runway gradient, and for the ambient temperature and wind component existing at the time of takeoff. (See secs. 4T.123(b) and 4T.743(b).)

**40T.83 En route limitations.** All airplanes shall be operated in compliance with paragraph (a) of this section. In addition, no airplane shall be flown along an intended route if any place along the route is more than 90 minutes away from an airport at which a landing can be made in accordance with section 40T.84(b), assuming all engines to be operating at cruising power, unless compliance is shown with paragraph (b) of this section.

(a) **One engine inoperative.** No airplane shall be taken off at a weight in excess of that which, according to the one-engine-inoperative en route net flight path data shown in the Airplane Flight Manual, will permit compliance with either subparagraphs (1) or (2) of this paragraph at all points along the route. The net flight path shall have a positive slope at 1,500 feet above the airport where the landing is assumed to be made after the engine fails. The net flight path used shall be for the ambient temperatures anticipated along the route. (See secs. 4T.123(b) and 4T.743(b).)

(1) The slope of the net flight path shall be positive at an altitude of at least 1,000 feet above all terrain and obstructions along the route within 5 statute miles (4.34 nautical miles) on either side of the intended track.

(2) The net flight path shall be such as to permit the airplane to continue flight from the cruising altitude to an airport where a landing can be made in accordance with the provisions of section 40T.84(b), the net flight path clearing vertically by at least 2,000 feet all terrain and obstructions along the route within 5 statute miles (4.34 nautical miles) on either side of the intended track. The provisions of subdivisions (i) through (vi) of this subparagraph shall apply.

(i) The engine shall be assumed to fail at the most critical point along the route.

(ii) The airplane shall be assumed to pass over the critical obstruction following engine failure at a point no closer to the critical

obstruction than the nearest approved radio navigational fix, except that the Administrator may authorize a procedure established on a different basis where adequate operational safeguards are found to exist.

(iii) An approved method shall be used to account for winds which would otherwise adversely affect the flight path.

(iv) Fuel jettisoning shall be permitted if the Administrator finds that the operator has an adequate training program, proper instructions are given to the flight crew, and all other precautions are taken to ensure a safe procedure.

(v) The alternate airport shall be specified in the dispatch release and shall meet the prescribed weather minima.

(vi) The consumption of fuel and oil after the engine is assumed to fail shall be that which is accounted for in the net flight path data shown in the Airplane Flight Manual.

(b) *Two engines inoperative.* No airplane shall be taken off at a weight in excess of that which, according to the two-engine-inoperative en route net flight path data shown in the Airplane Flight Manual, will permit the airplane to continue flight from the point where two engines are assumed to fail simultaneously to an airport where a landing can be made in accordance with the provisions of section 40T.84(b), the net flight path clearing vertically by at least 2,000 feet all terrain and obstructions along the route within 5 statute miles (4.34 nautical miles) on either side of the intended track. The net flight path considered shall be for the ambient temperatures anticipated along the route. The provisions of subparagraphs (1) through (5) of this paragraph shall apply. (See secs. 4T.123(b) and 4T.734(b).)

(1) The two engines shall be assumed to fail at the most critical point along the route.

(2) The net flight path shall have a positive slope at 1,500 feet above the airport where the landing is assumed to be made after failure of two engines.

(3) Fuel jettisoning shall be permitted if the Administrator finds that the operator has an adequate training program, proper instructions are given to the flight crew, and all other precautions are taken to ensure a safe procedure.

(4) The airplane's weight at the point where the two engines are assumed to fail shall be considered to be not less than that which would include sufficient fuel to proceed to the airport and to arrive there at an altitude of at least 1,500 feet directly over the landing area and thereafter to fly for 15 minutes at cruise power and/or thrust.

(5) The consumption of fuel and oil after the engines are assumed to fail shall be that which is accounted for in the net flight path data shown in the Airplane Flight Manual.

#### 40T.84 *Landing limitations.*

(a) *Airport of destination.* No airplane shall be taken off at a weight in excess of that which, in accordance with the landing distances shown in the Airplane Flight Manual for the elevation of the airport of intended destination and for the wind conditions anticipated there at the time of landing, would permit the airplane to be brought to rest at the airport of intended destination within 60 percent of the effective length of the runway from a point 50 feet directly above the intersection of the

obstruction clearance plane and the runway. The weight of the airplane shall be assumed to be reduced by the weight of the fuel and oil expected to be consumed in flight to the airport of intended destination. Compliance shall be shown with the conditions of subparagraphs (1) and (2) of this paragraph. (See secs. 4T.123(b) and 4T.743(b).)

(1) It shall be assumed that the airplane is landed on the most favorable runway and direction in still air.

(2) It shall be assumed that the airplane is landed on the most suitable runway considering the probable wind velocity and direction and taking due account of the ground handling characteristics of the airplane and of other conditions (i.e., landing aids, terrain, etc.). If full compliance with the provisions of this subparagraph is not shown, the airplane may be taken off if an alternate airport is designated which permits compliance with paragraph (b) of this section.

(b) *Alternate airport.* No airport shall be designated as an alternate airport in a dispatch release unless the airplane at the weight anticipated at the time of arrival at such airport can comply with the provisions of paragraph (a) of this section, provided that the airplane can be brought to rest within 70 percent of the effective length of the runway.

4. In lieu of section 43.11 of Part 43 of the Civil Air Regulations the following shall be applicable.

43T.11 *Transport category airplane weight limitations.* The performance data in the Airplane Flight Manual shall be applied in determining compliance with the following provisions:

(a) No airplane shall be taken off at a weight which exceeds the takeoff weight specified in the Airplane Flight Manual for the elevation of the airport and for the ambient temperature existing at the time of the takeoff. (See secs. 4T.123(a)(1) and 4T.743(a).)

(b) No airplane shall be taken off at a weight such that, allowing for normal consumption of fuel and oil in flight to the airport of destination and to the alternate airports, the weight on arrival will exceed the landing weight specified in the Airplane Flight Manual for the elevation of each of the airports involved and for the ambient temperatures anticipated at the time of landing. (See secs. 4T.123(a)(2) and 4T.743(a).)

(c) No airplane shall be taken off at a weight which exceeds the weight at which, in accordance with the minimum distances for takeoff scheduled in the Airplane Flight Manual, compliance with subparagraphs (1) through (3) of this paragraph is shown. These distances shall correspond with the elevation of the airport, the runway to be used, the effective runway gradient, and the ambient temperature and wind component existing at the time of takeoff. (See secs. 4T.123(a)(3) and 4T.734(a).)

(1) The accelerate-stop distance shall not be greater than the length of the runway plus the length of the stopway if present.

(2) The takeoff distance shall not be greater than the length of the runway plus the length of the clearway if present, except that the length of the clearway shall not be greater than one-half of the length of the runway.

(3) The takeoff run shall not be greater than the length of the runway.

(d) No airplane shall be operated outside the operational limits specified in the Airplane Flight Manual. (See secs. 4T.123(a)(4) and 4T.743(a).)

5. The following definitions shall apply:

(a) *Clearway.* A clearway is an area beyond the runway, not less than 500 feet wide, centrally located about the extended center line of the runway, and under the control of the airport authorities. The clearway is expressed in terms of a clearway plane, extending from the end of the runway with an upward slope not exceeding 1.25 percent, above which no object nor any portion of the terrain protrudes, except that threshold lights may protrude above the plane if their height above the end of the runway is not greater than 26 inches and if they are located to each side of the runway.

NOTE: For the purpose of establishing takeoff distances and takeoff runs, in accordance with section 4T.117 of this regulation, the clearway plane is considered to be the takeoff surface.

(b) *Stopway.* A stopway is an area beyond the runway, not less in width than the width of the runway, centrally located about the extended center line of the runway, and designated by the airport authorities for use in decelerating the airplane during an aborted takeoff: To be considered as such, a stopway must be capable of supporting the airplane during an aborted takeoff without inducing structural damage to the airplane. (See also sec. 4T.115(d) of this regulation.)

(Pages 311 through 313 deleted by Supplement No. 1 dated February 1, 1963. Page 315 follows.)



SPECIAL CIVIL AIR REGULATIONS NO. SR-423

Effective: December 20, 1957

Adopted: November 15, 1957

Type Certification of Transport Category Airplanes With Turbo-Prop Replacements

The airworthiness requirements with which a particular airplane is required to comply are established by the date of application for the type certificate. After the type certificate is issued, the holder of the type certificate or an applicant for a supplemental type certificate, at his option, can obtain approval of changes in the design in accordance with requirements in effect at the time of the original application for type certificate or in accordance with later requirements in effect at the time of the change.

Prior to May 18, 1954, the regulations placed no specific limit on the extent of changes to the airplane which could be approved in this manner nor did they define a new type design for which a new application for type certification would be required. Amendment 4b-1 effective on that date, among other changes in Part 4b, lists certain changes in design which if made to an airplane would require it to be considered as a new type. In such a case, a new application for type certification would be required and the regulations, together with all amendments thereto effective on the date of the new application, would have to be complied with (sec. 4b.11(a)). One such change which would require a new type certificate is a change to engines employing different principles of operation or propulsion (sec 4b.11(e)(2)).

Interest has been shown recently within the aviation industry in the installation of turbo-propeller engines on airplanes presently equipped with reciprocating engines. In accordance with sec. 4b.11(e)(2) such a change would require a showing of compliance with the latest airworthiness requirements of Part 4b. The Board is of the opinion that showing of compliance with all of the latest requirements might be burdensome, impractical, and not essential to safety.

This Special Civil Air Regulation will permit the certification of a turbo-propeller-powered airplane, which previously was type certificated with the same number of reciprocating engines, if compliance is shown with the airworthiness provisions applicable to the airplane as type certificated with reciprocating engines, together with certain later provisions of the Civil Air Regulations in effect on the date of application for a supplemental or new type certificate which are applicable or related to the powerplant of the turbo-propeller-powered version.

In order to insure that the level of safety of the turbine-powered airplane is equivalent to that intended by Part 4b, the Board considers that compliance must be shown with the later provisions of Part 4b which apply to the powerplant installation, airplane performance, and cockpit standardization, such other requirements as the Administrator finds are otherwise related to the changes made in the engines.

Special Civil Air Regulation No. SR-422 establishes certain certification and operational requirements for all turbine-powered airplanes for which a type certificate is issued after the effective date of that regulation. Except as otherwise provided, all of the provisions of SR-422 remain applicable to airplanes certificated in accordance with the regulation prescribed herein. Therefore, to be certificated in accordance with the regulation prescribed herein compliance must be shown with the certification performance requirements prescribed in paragraph 2 of SR-422.

It must be emphasized that the certification performance limitations established by the performance requirements; i.e., the take-off weights, landing weights, take-off and accelerate-stop distances, and the operational limits, become part of the airworthiness certificate and must be complied with at all times, regardless of the type of operations conducted with the airplane. (See sec. 43.10, as amended, of Part 43 of the Civil Air Regulations.)

In addition to certification performance limitations, SR-422 prescribes performance operating limitations which are applicable to turbine-powered transport category airplanes when used in air carrier passenger operations. Since turbo-propeller-powered airplanes certificated in accordance with the regulation prescribed herein are required to comply with the certification performance requirements of SR-422, they are also subject to the performance operating limitations prescribed in paragraph 3 of SR-422 when used in air carrier passenger operations.

Since a change in engines will require a rather extensive change in the cockpit to accommodate the new instruments and controls for turbine engines, the Board considers that compliance with the latest cockpit standardization requirements can be accomplished without any undue burden and such compliance would speed up the cockpit standardization of other airplanes in an airline's fleet in accordance with the Board's objectives. Therefore, this regulation makes the latest cockpit standardization requirements applicable, with the exception of such detailed requirements as the Administrator finds are impracticable, and do not contribute materially to standardization. It should be noted that in referring to this exception in the preamble to Draft Release No. 56-29, the use of the conjunction "or" after the word "impracticable" was inadvertent. As the language of the proposed regulation clearly indicated, "and" was the proper conjunction following the word "impracticable."

The Board also considers it appropriate to call attention to the fact that if other changes to the airplane are made simultaneously with, or subsequent to, such an engine change, then compliance will also have to be shown with all requirements related to the additional changes in effect on the date of the new application for a supplemental or new type certificate. In this regard, if an airplane converted to turbo-propeller power is to be certificated for operation at altitudes, speeds, or weights higher than those which are applicable to the reciprocating-engine-powered airplane, compliance will be required with all the latest provisions of the regulations which are related to such changes.

In order to assure that all airplanes converted to turbo-propeller power meet the minimum requirements considered essential to safety, this regulation is made retroactive and requires compliance with the provisions of the Civil Air Regulations as set forth herein for all of such

airplanes for which application for a supplemental or new type certificate was made prior to the effective date of this regulation.

This Special Civil Air Regulation shall continue in effect for 5 years, at the end of which time the effectiveness of the regulation will be evaluated for the purpose of considering the incorporation of the substance of these rules in the permanent body of the Civil Air Regulations.

Interested persons have been afforded an opportunity to participate in the making of this Special Civil Air Regulation (21 F.R. 9436), and due consideration has been given to all relevant matter presented.

In consideration of the foregoing, the Civil Aeronautics Board hereby makes and promulgates the following Special Civil Air Regulation effective December 20, 1957.

Contrary provisions of section 4b.11(a) as it applies to section 4b.11 (e)(2) of Part 4b of the Civil Air Regulations and paragraph (1) of Special Civil Air Regulation No. SR-422 notwithstanding, the following provisions shall be applicable to the certification of a turbo-propeller-powered airplane which was previously type certificated with the same number of reciprocating engines:

(1) The airworthiness regulations applicable to the airplane as type certificated with reciprocating engines and, in addition thereto or in lieu thereof as appropriate, the following provisions of the Civil Air Regulations effective on the date of application for a supplemental or new type certificate (see paragraph (3)):

(a) The certification performance requirements prescribed in Special Civil Air Regulation No. SR-422;

(b) The powerplant installation requirements of Part 4b applicable to the turbo-propeller-powered airplane;

(c) The requirements of Part 4b for the standardization of cockpit controls and instruments, except where the Administrator finds that showing of compliance with a particular detailed requirement would be impractical and would not contribute materially to standardization; and

(d) Such other requirements of Part 4b applicable to the turbo-propeller-powered airplane as the Administrator finds are related to the changes in engines and are necessary to insure a level of safety of the turbo-propeller-powered airplane equivalent to that generally intended by Part 4b.

(2) If new limitations are established with respect to weight, speed, or altitude of operation and the Administrator finds that such limitations are significantly altered from those approved for the airplane with reciprocating engines, compliance shall be shown with all of the requirements, applicable to the specific limitations being changed, which are in effect on the date of application for the new or supplemental type certificate.

(3) Airplanes converted to turbo-propeller power, for which application for a supplemental or a new type certificate was made prior to the effective date of this Special Civil Air Regulation, shall comply with all of the provisions of the Civil Air Regulations specified in paragraphs (1) and (2) effective on the date of this special regulation, rather than those provisions effective on the date application was made for the supplemental or the new type certificate.

This Special Civil Air Regulation shall terminate December 20, 1962 unless sooner superseded or rescinded by the Board.

SPECIAL CIVIL AIR REGULATION NO. 425C

Effective: June 6, 1961  
Adopted: May 31, 1961  
Published: June 6, 1961  
(26 F.R. 4990)

Provisional Certification and Operation of Aircraft

Special Civil Air Regulation No. SR-425A was adopted on July 22, 1958, to provide for provisional certification of turbine-powered transport category airplanes in order to permit certain air carriers and manufacturers to conduct crew training, service testing, and simulated air carrier operations prior to introduction of the airplanes into commercial service. The objective of this regulation was to provide a means whereby the air carriers and manufacturers could obtain as much experience as possible with turbine-powered airplanes which, although safe for flight, had not been approved for the issuance of a type certificate.

Special Civil Air Regulation No. SR-425B, which superseded SR-425A, was adopted on April 7, 1960, to extend the application of the regulation to: (1) piston-engine transport category aircraft, including rotorcraft; and (2) personal and executive type aircraft, including rotorcraft, irrespective of powerplant type. In addition, this regulation permitted operations such as sales demonstrations and market surveys with aircraft having a provisional type and airworthiness certificate.

To accomplish this, SR-425B provided for, among other things, the issuance of two classes of provisional type and airworthiness certificates. Class I provisional and airworthiness certificates could be issued for all types of aircraft for operation by the aircraft manufacturer. Class II provisional type and airworthiness certificates could be issued only for transport category aircraft, but these aircraft could be operated by either the aircraft manufacturer or a certificated air carrier. In general, the requirements for the issuance of Class I provisional certificates were less stringent, and the operating limitations less confining, than those for the issuance of Class II provisional certificates.

Under the provisions of SR-425B, however, eligibility to apply for Class I provisional certificates was limited to aircraft manufacturers. A recommendation that this eligibility be extended to include engine manufacturers had been evaluated by the Agency prior to the adoption of SR-425B, but rule making action on such extension was deferred until additional experience with provisional certification could be acquired.

Experience accumulated since the adoption of SR-425B has indicated that it would be practicable for engine manufacturers, who have altered a type certificated aircraft by installing type certificated engines of their own manufacture in place of the original engines, to show compliance with the currently effective requirements for issuance of Class I provisional type and provisional airworthiness certificates; and that compliance with these requirements will insure safe operation of provisionally certificated aircraft by such engine manufacturers. Further, the Agency

believes that operations conducted by engine manufacturers under the terms of Class I provisional certificates, for the purpose of sales demonstrations, market surveys, and other similar activities related to the sale of their engines, would contribute to the promotion and development of civil aeronautics in the United States.

SR-425B is therefore being superseded by SR-425C to permit certain engine manufacturers to apply for Class I provisional type and provisional airworthiness certificates if they have applied for the issuance of a supplemental type certificate.

Since this is a superseding regulation which relieves restrictions and imposes no additional burden on any person, notice and public procedures hereon are unnecessary, and this regulation may be made effective on less than 30 days' notice.

In consideration of the foregoing, the following Special Civil Air Regulation is adopted to become effective June 6, 1961:

#### GENERAL

1. *Applicability.* Contrary provisions of the Civil Air Regulations notwithstanding, provisional type and airworthiness certificates, amendments to provisional type certificates, and provisional amendments to type certificates, will be issued as prescribed in this regulation to a manufacturer or an air carrier. As used in this regulation, a manufacturer shall mean only a manufacturer who is a citizen of the United States; and the term air carrier shall not include an air taxi operator.

#### 2. *Eligibility.*

(a) A manufacturer of aircraft manufactured by him within the United States may apply for Class I or Class II provisional type and provisional airworthiness certificates, for amendments to provisional type certificates held by him, and for provisional amendments to type certificates held by him.

(b) An air carrier holding an air carrier operating certificate authorizing him to conduct operations under Parts 40, 41, 42, or 46 of the Civil Air Regulations may apply for Class II provisional airworthiness certificates for transport category aircraft which meet the conditions of either subparagraphs (1) or (2) of this paragraph.

(1) The aircraft has a currently valid Class II provisional type certificate or an amendment thereto;

(2) The aircraft has a currently valid provisional amendment to a type certificate which was preceded by a corresponding Class II provisional type certificate.

(c) An engine manufacturer who has altered a type certificated aircraft by installing different type certificated engines, manufactured by him within the United States, in place of the original engines, may apply for Class I provisional type and provisional airworthiness certificates for such aircraft, and for amendments to Class I provisional type certificates held by him, if the basic aircraft, before alteration was type certificated in the normal, utility, acrobatic, or transport category.

#### 3. *Application.*

(a) *General.* Applications for provisional type and airworthiness certificates, for amendments to provisional type certificates, and for

provisional amendments to type certificates, shall be submitted to the Chief, Flight Standards Division, FAA, of the Regional Office in which the manufacturer or air carrier is located and shall be accompanied by the pertinent information specified in this regulation.

4. *Duration.* Unless sooner surrendered, superseded, revoked, or otherwise terminated, certificates and amendments thereto, shall have periods of duration in accordance with paragraphs (a) through (f) of this section.

(a) A Class I provisional type certificate shall remain in effect for 24 months after the date of its issuance or until the date of issuance of the corresponding type or supplemental type certificate, whichever occurs first.

(b) A Class I provisional type certificate shall expire immediately upon issuance of a Class II provisional type certificate for aircraft of the same type design.

(c) A Class II provisional type certificate shall remain in effect for 6 months after the date of its issuance or 60 days after the date of issuance of the corresponding type certificate, whichever occurs first.

(d) An amendment to a Class I or a Class II provisional type certificate shall remain in effect for the duration of the corresponding provisional type certificate.

(e) A provisional amendment to a type certificate shall remain in effect for 6 months after its approval or until the amendment to the type certificate is approved, whichever occurs first.

(f) Provisional airworthiness certificates shall remain in effect for the duration of the corresponding provisional type certificate, amendment to a provisional type certificate, or a provisional amendment to the type certificate.

5. *Transferability of certificates.* Certificates issued pursuant to this regulation are not transferable except that a Class II provisional airworthiness certificate may be transferred to an air carrier eligible to apply for such certificate under section 2 of this regulation.

6. *Display of certificates and markings.* A provisional airworthiness certificate shall be prominently displayed in the aircraft for which it is issued. The words "Provisional Airworthiness" shall be painted in letters not less than 2 inches high on the exterior of such aircraft adjacent to each entrance to the cabin and cockpit of the aircraft.

#### REQUIREMENTS FOR ISSUANCE

7. *Class I provisional type certificates.* A Class I provisional type certificate and amendments thereto will be issued for a particular type design when the eligible aircraft or engine manufacturer shows compliance with the provisions of paragraphs (a) through (f) of this section, and an authorized representative of the Administrator finds, on the basis of information submitted to him by the manufacturer in compliance with the provisions of this section and of other relevant information, that there is no feature, characteristic, or condition which would render the aircraft unsafe when operated in accordance with the limitations established in paragraph (d) of this section and in section 13 of this regulation.

(a) The manufacturer has applied for the issuance of a type or supplemental type certificate for the aircraft.

(b) The manufacturer certifies that the aircraft has met the provisions of subparagraphs (1) through (3) of this paragraph.

(1) The aircraft has been designed and constructed in accordance with the airworthiness requirements applicable to the issuance of the type or supplemental type certificate for the aircraft;

(2) The aircraft substantially complies with the applicable flight characteristics requirements for the type or supplemental type certificate;

(3) The aircraft can be operated safely under the appropriate operating limitations specified in this regulation.

(c) The manufacturer has submitted a report showing that the aircraft had been flown in all maneuvers necessary to show compliance with the flight requirements for the issuance of the type or supplemental type certificate and to establish that the aircraft can be operated safely in accordance with the limitations specified in this regulation.

(d) The manufacturer has established limitations with respect to weights, speeds, flight maneuvers, loading, operation of controls and equipment, and all other relevant factors. The limitations shall include all the limitations required for the issuance of a type or supplemental type certificate for the aircraft: *Provided, That*, where such limitations have not been established, appropriate restrictions on the operation of the aircraft shall be established.

(e) The manufacturer has established an inspection and maintenance program for the continued airworthiness of the aircraft.

(f) A prototype aircraft has been flown by the manufacturer for at least 50 hours pursuant to the authority of an experimental certificate issued under Part 1 of the Civil Air Regulations or under the auspices of a United States military service: *Provided, That* the number of flight hours may be reduced by the authorized representative of the Administrator in the case of an amendment to a provisional type certificate.

8. *Class I provisional airworthiness certificates.* Except as provided in section 12 of this regulation, a Class I provisional airworthiness certificate will be issued for an aircraft, for which a Class I provisional type certificate is in effect, when the eligible aircraft or engine manufacturer shows compliance with the provisions of paragraphs (a) through (d) of this section, and an authorized representative of the Administrator finds that there is no feature, characteristic, or condition of the aircraft which would render the aircraft unsafe when operated in accordance with the limitations established in sections 7(d) and 13 of this regulation.

(a) The manufacturer is the holder of the provisional type certificate for the aircraft.

(b) The manufacturer submits a statement that the aircraft conforms to the type design corresponding with the provisional type certificate and has been found by him to be in safe operating condition under the applicable limitations.

(c) The aircraft has been flown at least 5 hours by the manufacturer.

(d) The aircraft has been supplied with a provisional aircraft flight manual or other document and appropriate placards containing the limitations required by sections 7(d) and 13 of this regulation.

9. *Class II provisional type certificates.* A Class II provisional type certificate and amendments thereto will be issued for a particular transport category type design when the manufacturer of the aircraft shows compliance with the provisions of paragraphs (a) through (h) of this section, and an authorized representative of the Administrator finds, on the basis of information submitted to him by the manufacturer in compliance with the provisions of this section and of other relevant information, that there is no feature, characteristic, or condition which would render the aircraft unsafe when operated in accordance with the limitations established in paragraph (f) of this section and in sections 13 and 14 of this regulation.

(a) The manufacturer has applied for the issuance of a transport category type certificate for the aircraft.

(b) The manufacturer holds a type certificate and a currently effective production certificate for at least one other aircraft in the same transport category as the subject aircraft.

(c) The Agency's official flight test program with respect to the issuance of a type certificate for the aircraft is in progress.

(d) The manufacturer certifies that the aircraft has met the provisions of subparagraphs (1) through (3) of this paragraph.

(1) The aircraft has been designed and constructed in accordance with the airworthiness requirements applicable to the issuance of the type certificate for the aircraft;

(2) The aircraft substantially complies with the applicable flight characteristics requirements for the type certificate;

(3) The aircraft can be operated safely under the appropriate operating limitations specified in this regulation.

(e) The manufacturer has submitted a report showing that the aircraft had been flown in all maneuvers necessary to show compliance with the flight requirements for the issuance of the type certificate and to establish that the aircraft can be operated safely in accordance with the limitations specified in this regulation.

(f) The manufacturer has prepared a provisional aircraft flight manual which includes limitations with respect to weights, speeds, flight maneuvers, loading, operation of controls and equipment, and all other relevant factors. The limitations shall include all the limitations required for the issuance of a type certificate for the aircraft: *Provided, That, where such limitations have not been established, the provisional flight manual shall contain appropriate restrictions on the operation of the aircraft.*

(g) The manufacturer has established an inspection and maintenance program for the continued airworthiness of the aircraft.

(h) A prototype aircraft has been flown by the manufacturer for at least 100 hours pursuant to the authority of either an experimental certificate issued under Part 1 of the Civil Air Regulations or a Class I provisional airworthiness certificate: *Provided, That the number of flight hours may be reduced by the authorized representative of the Administrator in the case of an amendment to a provisional type certificate.*



**10. Class II provisional airworthiness certificates.** Except as provided in section 12 of this regulation, a Class II provisional airworthiness certificate will be issued for an aircraft, for which a Class II provisional type certificate is in effect, when the applicant shows compliance with the provisions of paragraphs (a) through (e) of this section, and an authorized representative of the Administrator finds that there is no feature, characteristic, or condition of the aircraft which would render the aircraft unsafe when operated in accordance with the limitations established in sections 9(f), 13, and 14 of this regulation.

(a) The applicant submits evidence that a Class II provisional type certificate for the aircraft has been issued to the manufacturer.

(b) The applicant submits a statement by the manufacturer that the aircraft has been manufactured under a quality control system adequate to insure that the aircraft conforms to the type design corresponding with the provisional type certificate.

(c) The applicant submits a statement that the aircraft has been found by him to be in a safe operating condition under the applicable limitations.

(d) The applicant submits a statement that the aircraft has been flown at least 5 hours by the manufacturer.

(e) The aircraft has been supplied with a provisional aircraft flight manual containing the limitations required by sections 9(f), 13, and 14 of this regulation.

**11. Provisional amendments to type certificate.** A provisional amendment to a type certificate will be approved when the manufacturer of the type certificated aircraft shows compliance with the provisions of paragraphs (a) through (g) of this section, and an authorized representative of the Administrator finds, on the basis of information submitted to him by the manufacturer in compliance with the provisions of this section and of other relevant information, that there is no feature, characteristic, or condition which would render the aircraft unsafe when operated in accordance with the limitations established in paragraph (e) of this section, and section 13 and, if applicable, section 14 of this regulation.

(a) The manufacturer has applied for an amendment to the type certificate.

(b) The Agency's official flight test program with respect to the amendment of the type certificate is in progress.

(c) The manufacturer certifies that the aircraft has met the provisions of subparagraphs (1) through (3) of this paragraph.

(1) The modification involved in the amendment to the type certificate has been designed and constructed in accordance with the airworthiness requirements applicable to the issuance of the type certificate for the aircraft;

(2) The aircraft substantially complies with the applicable flight characteristics requirements for the type certificate;

(3) The aircraft can be operated safely under the appropriate operating limitations specified in this regulation.

(d) The manufacturer has submitted a report showing that the aircraft incorporating the modifications involved had been flown in all maneuvers necessary to show compliance with the flight require-

ments applicable to these modifications and to establish that the aircraft can be operated safely in accordance with the limitations specified in this regulation.

(e) The manufacturer has established, in a provisional aircraft flight manual or other document and appropriate placards, limitations with respect to weights, speeds, flight maneuvers, loading, operation of controls and equipment, and all other relevant factors. The limitations shall include all the limitations required for the issuance of a type certificate for the aircraft: *Provided*, That, where such limitations have not been established, appropriate restrictions on the operation of the aircraft shall be established.

(f) The manufacturer has established an inspection and maintenance program for the continued airworthiness of the aircraft.

(g) An aircraft modified in accordance with the corresponding amendment to the type certificate has been flown by the manufacturer for the number of hours found necessary by the authorized representative of the Administrator, such flights having been conducted pursuant to the authority of an experimental certificate issued under Part I of the Civil Air Regulations.

12. *Provisional airworthiness certificates corresponding with provisional amendment to type certificate.* A Class I or a Class II provisional airworthiness certificate, as specified in section 2 of this regulation, will be issued for an aircraft, for which a provisional amendment to the type certificate has been issued, when the applicant shows compliance with the provisions of paragraphs (a) through (e) of this section, and an authorized representative of the Administrator finds that there is no feature, characteristic, or condition of the aircraft, as modified in accordance with the provisionally amended type certificate, which would render the aircraft unsafe when operated in accordance with the limitations established in sections 11(e) and 13 and, if applicable, section 14 of this regulation.

(a) The applicant submits evidence that approval has been obtained for the relevant provisional amendment to the type certificate for the aircraft.

(b) The applicant submits evidence that the modification to the aircraft was accomplished under a quality control system adequate to insure that the modification conforms to the provisionally amended type certificate.

(c) The applicant submits a statement that the aircraft has been found by him to be in a safe operating condition under the applicable limitations.

(d) The applicant submits a statement that the aircraft has been flown at least 5 hours by the manufacturer.

(e) The aircraft has been supplied with a provisional aircraft flight manual or other document and appropriate placards containing the limitations required by sections 11(e) and 13 and, if applicable, section 14 of this regulation.

#### OPERATING LIMITATIONS

13. *Operation of provisionally certificated aircraft.* An aircraft for which a provisional airworthiness certificate has been issued shall

be operated only by a person eligible to apply for a provisional airworthiness certificate in accordance with section 2 of this regulation. Operations shall be in compliance with paragraphs (a) through (j) of this section.

(a) The aircraft shall not be operated in air transportation unless so authorized in a particular case by the Director, Bureau of Flight Standards.

(b) Operations shall be restricted to the United States, its Territories and possessions.

(c) The aircraft shall be limited to the types of operations listed in subparagraphs (1) through (7) of this paragraph.

(1) Flights conducted by the aircraft or engine manufacturer in direct conjunction with the type or supplemental type certification of the aircraft;

(2) Training of flight crews, including simulated air carrier operations;

(3) Demonstration flights conducted by the manufacturer for prospective purchasers;

(4) Market surveys by the manufacturer;

(5) Flight checking of instruments, accessories, and equipment, the functioning of which does not adversely affect the basic airworthiness of the aircraft;

(6) Service testing of the aircraft;

(7) Such additional operations as may be specifically authorized by the authorized representative of the Administrator.

(d) All operations shall be conducted within the prescribed limitations displayed in the aircraft or set forth in the provisional aircraft flight manual or other document containing the limitations for the safe operation of the aircraft: *Provided*, That operations conducted in direct conjunction with the type or supplemental type certification of the aircraft shall be subject to the experimental aircraft limitations of section 1.74 of Part 1 of the Civil Air Regulations, and all "flight tests" as defined in section 60.60 of the Civil Air Regulations shall be conducted in accordance with the requirements of section 60.24 of that part.

(e) The operator shall establish procedures for the use and guidance of flight and ground personnel in the conduct of operations under this section. Specific procedures shall be established for operations from and into airports where the runways require takeoffs or approaches over populated areas. All procedures shall be approved by an authorized representative of the Administrator. All operations shall be conducted in accordance with such approved procedures.

(f) The operator shall insure that each flight crewmember is properly certificated and possesses adequate knowledge of, and familiarity with, the aircraft and the procedures to be used by him.

(g) The aircraft shall be maintained in accordance with applicable Civil Air Regulations, with the inspection and maintenance program established in accordance with this regulation, and with any special inspections and maintenance conditions prescribed by an authorized representative of the Administrator.

(h) No aircraft shall be operated under authority of a provisional airworthiness certificate if the manufacturer or the authorized

representative of the Administrator determines that a change in design, construction, or operation is necessary to insure safe operation, until such change is made and approved by the authorized representative of the Administrator. Section 1.24 of Part 1 of the Civil Air Regulations shall be applicable to operations under this section.

(i) Only those persons who have a bona fide interest in the operations permitted under this section or who are specifically authorized by both the manufacturer and the authorized representative of the Administrator may be carried in provisionally certificated aircraft: *Provided*, That they have been advised by the operator of the provisional certification status of the aircraft.

(j) The authorized representative of the Administrator may prescribe such additional limitations or procedures as he finds necessary. This shall include limitations on the number of persons who may be carried aboard the aircraft.

14. *Additional limitations to operations by air carriers.* In addition to the limitations in section 13 of this regulation, operations by air carriers shall be subject to the provisions of paragraphs (a) through (d) of this section.

(a) In addition to crewmembers, the aircraft may carry only those persons who are listed in section 40.356(c) of Part 40 of the Civil Air Regulations or who are specifically authorized by both the air carrier and the authorized representative of the Administrator.

(b) The air carrier shall maintain current records for each flight crewmember. These records shall include such information as is necessary to show that each flight crewmember is properly trained and qualified to perform his assigned duties.

(c) The appropriate instructor, supervisor, or check airman shall certify to the proficiency of each flight crewmember and such certification shall become a part of the flight crewmember's record.

(d) A log of all flights conducted under this regulation, and accurate and complete records of inspections made and maintenance accomplished, shall be kept by the air carrier and made available to the manufacturer and to an authorized representative of the Administrator.

15. *Other operations.* The Director, Bureau of Flight Standards, may credit toward the aircraft proving test requirements of the applicable air carrier regulations such operations conducted pursuant to this special regulation as he finds have met the applicable aircraft proving test requirements: *Provided*, That he also finds that there is no significant difference between the provisionally certificated aircraft and the aircraft for which application is made for operation pursuant to an air carrier operating certificate.

#### CERTIFICATES ISSUED UNDER SR-425A AND SR-425B

16. *Duration.* Currently valid provisional type and airworthiness certificates issued in accordance with Special Civil Air Regulations Nos. SR-425A and SR-425B shall remain in effect for the durations and under the conditions prescribed in those regulations.

This special regulation supersedes Special Civil Air Regulation No. SR-425B and shall terminate on June 30, 1963, unless sooner superseded, rescinded, or otherwise terminated.

SPECIAL CIVIL AIR REGULATION NO. SR-426

Effective: October 27, 1958

Adopted: September 22, 1958

Performance Credit for Transport Category Airplanes Equipped with Standby Power

Standby power is power and/or thrust obtained from rocket engines and is separate from the power obtained from the airplane's main engines. Such power and/or thrust is available for a relatively short period for use in cases of emergency. The standby power system may be capable of producing more than a single thrust period. This special regulation authorizes the Administrator to grant performance credit to transport category airplanes when standby power is used in one or more of the following regimes of flight: Takeoff with one engine inoperative, approach climb with one engine inoperative, and the balked landing climb. By "performance credit" is meant the taking into account the increased performance of the airplane with standby power and, because thereof, the approval of higher maximum weights for the airplane than the weights approved on the basis of the airplane's performance without standby power. In granting performance credit, this regulation prescribes the applicable conditions and limitations.

Rocket assist takeoff units were developed initially for the military services to provide additional takeoff power for heavily loaded flying boats and carrier-based aircraft. The additional thrust improved the climb performance in the takeoff regime and permitted the airplane to attain a safe altitude and air speed in the event of engine failure. The reliability of such units has increased to the point where some civil operators have adopted them for use as emergency standby power in the event of engine failure. Other operators have been reluctant to adopt standby power installations and the attendant weight penalties without reasonable performance credit being given the airplane. With the performance credit granted by this regulation for the use of standby power, it is anticipated that such credit might be considered a compensating economic factor justifying the installation of standby power on such airplanes.

The currently effective regulations did not contemplate the use of standby power; however, the Administrator of Civil Aeronautics has established for an interim period a conservative policy permitting transport category airplanes equipped with standby power to operate at an increase in the normally approved weights by an amount equal to the weight of the standby power units.

In this regulation, the criteria for granting performance credit were formulated with the intent of providing an overall level of performance equivalent to that intended by the currently effective regulations. To this end, appropriate criteria are established with respect to the amount of performance credit which may be applied in determining the new takeoff paths, the extent to which the maximum certificated takeoff and landing weights may be increased, and operating procedures to be followed in service for the use of standby power and for the associated changes in the airplane's configuration and speed.

The basic element of the various criteria established in this regulation entails a comparison of flight paths. In Civil Air Regulations

Draft Release No. 57-28, all of the flight paths were based on procedures involving attainment of the en route configuration and the acceleration to a safe en route speed. Further consideration of this proposal indicates that an undue amount of flight testing and computation would be required for those flight conditions which presently do not involve the establishment of such flight paths. In addition, it appears that comparison of flight paths involving a particular procedure is not essential for the purpose of establishing an equivalent level of safety. In view of the foregoing, this regulation requires comparison of flight paths with respect to the takeoff regime consistent only with that required by the currently effective airworthiness performance requirements; i.e., Part 4b and Special Civil Air Regulations Nos. SR-422 and SR-422A. Further, the establishment of maximum landing weights is based on a comparison of flight paths obtained with a fixed airplane configuration and at the speed and power condition appropriate to the all-engines-operating landing climb or the one-engine-inoperative approach climb, as applicable.

Performance credit for standby power with respect to the takeoff path is limited by the specification that the all-engines-operating takeoff path reflect a conservatively greater margin of overall performance than the one-engine-inoperative takeoff path with standby power in use. It is intended that this margin exist throughout the takeoff path prescribed by the applicable performance requirements. This regulation provides for the establishment of the margin by the Administrator; however, in no case can this margin be less than 15 percent. In view of the many different types of airplanes to which this regulation is applicable, a higher margin might be necessary in certain cases to insure safe day-to-day operations.

For reciprocating-engine-powered airplanes, the provisions of this regulation require that the applicant establish a procedure for the use of standby power for attaining the en route configuration and a safe en route speed in the event of an engine failure during the takeoff. Provisions for such procedures are contained in the regulations for turbine-powered airplanes and will therefore be applicable to such airplanes. The establishment of the procedures made applicable to reciprocating-engine-powered airplanes is left to the discretion of the applicant to select the altitude at which the acceleration is to take place, the basic limitation being that the slope along all points of the airborne portion of the takeoff path must be positive. This will provide for the critical operation of cleanup and acceleration during the takeoff which are not covered by the performance requirements of Part 4b and which have been cited in the past in connection with several accidents. In addition, with respect to the clearing of obstacles, the takeoff path scheduled in the Airplane Flight Manual for airplanes for which the performance requirements of Part 4b are applicable must be appropriately modified to reflect the effect of the aforementioned procedure.

The criteria for the establishment of maximum certificated takeoff weights involve two separate comparisons of takeoff paths. These comparisons must be carried out to a height of 400 feet above the takeoff surface. This minimum height is intended to be associated with a procedure where standby power is actuated within the neighborhood of

the critical engine failure speed  $V_1$ . These provisions are intended to limit the increase in maximum takeoff weight consistent with the overall level of performance currently attained with respect to the one-engine-inoperative takeoff and to limit the amount of standby power for which performance credit can be granted to insure a reasonable margin of performance for the all-engine day-to-day operations.

The provisions for the establishment of maximum certificated landing weights require only a comparison between two flight paths based on a steady climb and fixed configuration. One represents a climb path at the maximum weight previously certificated without standby power and the other a climb path at the increased weight with standby power. In addition, there is a provision which requires the establishment of procedures for the execution of balked landings and missed approaches in conjunction with the use of standby power.

A question has been raised as to whether duplicate sets of standby power units are required to obtain performance credit for both the takeoff and the approach stages of flight. It is intended by this regulation to require duplicate sets of standby power for a flight for which the use of standby power is necessary to comply with both the maximum certificated takeoff and the maximum certificated approach weight limitations. Where the use of standby power is necessary for compliance with the maximum certificated weight limitations for only one regime of flight, i.e., takeoff or approach, one set of standby power units is required.

There are also included safety criteria for the installation and operation of the standby power system.

The Board presently has under consideration a special regulation which would be applicable to nontransport category airplanes equipped with standby power.

Interested persons have been afforded an opportunity to participate in the making of this regulation (22 F.R. 10464), and due consideration has been given to all relevant matter presented.

In consideration of the foregoing, the Civil Aeronautics Board hereby makes and promulgates the following Special Civil Air Regulation, effective October 27, 1958.

Contrary performance provisions of the Civil Air Regulations notwithstanding, the Administrator may grant performance credit for the use of standby power on transport category airplanes. Such credit shall be applicable only to the maximum certificated takeoff and landing weights, the takeoff distance, and the takeoff paths, and shall not exceed that found by the Administrator to result in an overall level of safety in the takeoff, approach, and landing regimes of flight equivalent to that prescribed in the regulations under which the airplane was originally certificated without standby power. (Note: Standby power is power and/or thrust obtained from rocket engines for a relatively short period and actuated only in cases of emergency.) The following provisions shall apply:

(1) *Takeoff; general.* The takeoff data prescribed in sections (2) and (3) shall be determined at all weights and altitudes, and at ambient temperatures if applicable, at which performance credit is to be applied.

**(2) Takeoff path.**

(a) The one-engine-inoperative takeoff path with standby power in use shall be determined in accordance with the performance requirements of the applicable airworthiness regulations.

(b) The one-engine-inoperative takeoff path (excluding that portion where the airplane is on or just above the takeoff surface) determined in accordance with paragraph (a) of this section shall lie above the one-engine-inoperative takeoff path without standby power at the maximum takeoff weight at which all of the applicable airworthiness requirements are met. For the purpose of this comparison, the flight path shall be considered to extend to at least a height of 400 feet above the takeoff surface.

(c) The takeoff path with all engines operating, but without the use of standby power, shall reflect a conservatively greater overall level of performance than the one-engine-inoperative takeoff path established in accordance with paragraph (a) of this section. The aforementioned margin shall be established by the Administrator to insure safe day-to-day operations, but in no case shall it be less than 15 percent. The all-engines-operating takeoff path shall be determined by a procedure consistent with that established in complying with paragraph (a) of this section.

(d) For reciprocating-engine-powered airplanes, the takeoff path to be scheduled in the Airplane Flight Manual shall represent the one-engine-inoperative takeoff path determined in accordance with paragraph (a) of this section and modified to reflect the procedure (see sec. (6)) established by the applicant for flap retraction and attainment of the en route speed. The scheduled takeoff path shall have a positive slope at all points of the airborne portion and at no point shall it lie above the takeoff path specified in paragraph (a) of this section.

(3) **Takeoff distance.** The takeoff distance shall be the horizontal distance along the one-engine-inoperative takeoff path determined in accordance with section (2)(a) from the start of the takeoff to the point where the airplane attains a height of 50 feet above the takeoff surface for reciprocating-engine-powered airplanes and a height of 35 feet above the takeoff surface for turbine-powered airplanes.

(4) **Maximum certificated takeoff weights.** The maximum certificated takeoff weights shall be determined at all altitudes, and at ambient temperatures if applicable, at which performance credit is to be applied and shall not exceed the weights established in compliance with paragraphs (a) and (b) of this section.

(a) The conditions of section (2) (b) through (d) shall be met at the maximum certificated takeoff weight.

(b) Without the use of standby power, the airplane shall meet all of the en route requirements of the applicable airworthiness regulations under which the airplane was originally certificated. In addition, turbine-powered airplanes without the use of standby power shall meet the final takeoff climb requirements prescribed in the applicable airworthiness regulations.

**(5) Maximum certificated landing weights.**

(a) The maximum certificated landing weights (one-engine-inoperative approach and all-engines-operating landing climb) shall be



determined at all altitudes, and at ambient temperatures if applicable, at which performance credit is to be applied and shall not exceed that established in compliance with the provisions of paragraph (b) of this section.

(b) The flight path, with the engines operating at the power and/or thrust appropriate to the airplane configuration and with standby power in use, shall lie above the flight path without standby power in use at the maximum weight at which all of the applicable airworthiness requirements are met. In addition, the flight paths shall comply with the provisions of subparagraphs (i) and (ii) of this paragraph.

(i) The flight paths shall be established without changing the appropriate airplane configuration.

(ii) The flight paths shall be carried out for a minimum height of 400 feet above the point where standby power is actuated.

(6) *Airplane configuration, speed, and power and/or thrust; general.* Any change in the airplane's configuration, speed, and power and/or thrust shall be made in accordance with the procedures established by the applicant for the operation of the airplane in service and shall comply with the provisions of paragraphs (a) through (c) of this section. In addition, procedures shall be established for the execution of balked landings and missed approaches.

(a) The Administrator shall find that the procedure can be consistently executed in service by crews of average skill.

(b) The procedure shall not involve methods or the use of devices which have not been proven to be safe and reliable.

(c) Allowances shall be made for such time delays in the execution of the procedures as may be reasonably expected to occur during service.

(7) *Installation and operation; standby power.* The standby power unit and its installation shall comply with the provisions of paragraphs (a) and (b) of this section.

(a) The standby power unit and its installation shall not adversely affect the safety of the airplane.

(b) The operation of the standby power unit and its control shall have proven to be safe and reliable.

SPECIAL CIVIL AIR REGULATION NO. SR-450A

Effective: Aug. 31, 1962

Adopted: Aug. 29, 1962

Published: Sept. 1, 1962

(27 F.R. 8760)

Airspeed Operation Limitation for Transport Category Airplanes

Special Civil Air Regulation No. SR-450, effective May 3, 1962 (27 F.R. 2995), contained a number of requirements dealing with airspeed operating limitations to airplanes certificated under the provisions of Part 4b in effect prior to May 3, 1962. A revision of the Airplane Flight Manual statement concerning airspeed operating limitations was prescribed for all such airplanes. Consistent revision of airspeed placards and instrument markings, and the installation of a speed warning device, were additionally prescribed for turbine-powered airplanes. The special regulation required compliance with the speed warning device provision on or before February 1, 1963; with all other provisions, on or before September 1, 1962.

Several operators of airplanes affected by SR-450 have requested extensions of the compliance dates specified therein, contending that compliance before these dates would be unnecessarily and excessively burdensome in relation to the attained increment of safety. With respect to the September 1, 1962, compliance date specified in section 1(a)(2), they point out that remarking airspeed instruments generally involves removal of the instrument seal. When this is done, the instrument is processed through a time-consuming overhaul schedule to make certain that its calibration has not been changed. They state, in addition, that the airplane manufacturer delayed delivery of the detailed service information required for the modification until necessary technical consultations with the instrument manufacturer, and with representatives of this Agency, could be completed. With respect to the February 1, 1963, date established for compliance with section 1(b), operators of turbine-powered airplanes not already equipped with a speed warning device report that they cannot obtain delivery of the device in less than 5 months; that installation of the device involves extensive electrical modifications, rework of the pitot-static pressure system, and other installation changes; that ground and flight tests are necessary to insure proper functioning of the modified systems; and that such modifications and tests, to be conducted in a safe manner, should be scheduled during a major airplane overhaul.

The Agency has determined that, for the reasons stated above and despite diligent efforts on their part, many persons affected by SR-450 will not be able to comply with its provisions before the specified dates and that a period of relief may be granted without adversely affecting safety. Accordingly, SR-450 has been amended by extending the September 1, 1962, compliance dates to March 1, 1963, and by extending the February 1, 1963, compliance date to February 1, 1964.

Since this regulation provides relief from the provisions of the previous regulation, and imposes no additional burden upon any persons, compliance with the notice and public procedure provisions of the Administrative Procedure Act is unnecessary, and good cause exists for making this regulation effective on less than 30 days' notice.

In consideration of the foregoing, the following Special Civil Air Regulation is hereby adopted to become effective August 31, 1962:

Contrary provisions of the Civil Air Regulations notwithstanding, the following requirements shall be applicable to transport category airplanes certificated under the provisions of Part 4b in effect prior to May 3, 1962:

**1. Turbine-powered airplanes.**

**(a) On or before March 1, 1963:**

(1) The airspeed operating limitations in the Airplane Flight Manual shall be revised by deleting the term "normal operating limit speed" and the corresponding symbols " $V_{NO}/M_{NO}$ ", together with statements explaining the significance of this term, and inserting in lieu thereof the term "maximum operating limit speed", the corresponding symbols " $V_{MO}/M_{MO}$ ", and the following statement explaining the significance of the new term:

"The maximum operating limit speed shall not be deliberately exceeded in any regime of flight (climb, cruise, or descent), except where a higher speed is specifically authorized for flight test or pilot training operations, or in approved emergency procedures."

(2) Airspeed placards and instrument markings shall be consistent with subparagraph (1) of this paragraph. Where color markings are used on airspeed or Mach indicators, the red radial line shall be at  $V_{NO}/M_{NO}$ . Where a maximum allowable airspeed indicator is used, the limit hand shall indicate  $V_{MO}/M_{MO}$ .

(b) On or before February 1, 1964, each airplane shall be equipped with a speed warning device which shall provide aural warning to the pilots, which is distinctly different from aural warnings used for other purposes, whenever the speed exceeds  $V_{MO}$  plus 6 knots or  $M_{MO} + 0.01$ . The upper limit of the production tolerances permitted for the warning device shall be at a speed not greater than the prescribed warning speed.

**2. Reciprocation engine-powered airplanes.** On or before March 1, 1963, the airspeed operating limitations in the Airplane Flight Manual shall be revised as necessary to state that the normal operating limit speed, or the maximum structural cruising speed (whichever term is used in the particular manual), shall not be deliberately exceeded in any regime of flight (climb, cruise, or descent), except where a higher speed is specifically authorized for flight test or pilot training operations, or in approved emergency procedures.

This regulation supersedes Special Civil Air Regulation No. SR-450.

# Appendix H

## FATIGUE EVALUATION OF FLIGHT STRUCTURE

The procedures outlined in this appendix are acceptable to the FAA for showing compliance with the fatigue evaluation requirements of Civil Air Regulation 4b.270. However, the information contained in this appendix is presented merely for guidance purposes and is not mandatory nor regulatory in nature.

Although a uniform approach to fatigue evaluation is desirable, it is recognized that in such a complex and highly controversial field, new design features and methods of fabrication, new approaches to fatigue evaluation, and new configurations may require variations and deviations from the procedures described in this appendix. Therefore, engineering judgment should be exercised for each particular application.

Experience with the application of methods of fatigue evaluation indicates that fatigue tests are essential to achieve the design objective. Even under the fail-safe method discussed in section II of this appendix, it is the general practice within industry to conduct fatigue tests for design information and guidance purposes. Fatigue tests are also useful in establishing a recommended inspection program; in assessing in the early design stages the fatigue characteristics of certain structural elements, such as major fittings, joints, typical skin units, and splices; in insuring that the anticipated service life assumed at the inception of the design can reasonably be attained; and in determining the crack propagation qualities of materials selected in specific design applications.

### Section I.—FATIGUE STRENGTH EVALUATION

A. *General.* The evaluation of the flight structure under the fatigue strength evaluation method is intended to insure that a serious

fatigue failure will not occur as a result of the repeated loads of variable magnitude expected in service. The evaluation usually includes the following procedures:

1. Estimating or measuring the expected loading spectrum for the structure.
2. Conducting a structural analysis including consideration of the stress concentration effects.
3. Fatigue testing the structure to cover the typical loading spectrum expected in service.
4. Determining reliable service periods by interpreting the results of the loading history, the variable load stress analyses, the fatigue tests, the service experience, and the fatigue analyses.
5. Providing inspection and maintenance instructions and guidance information to the operators to minimize the possibility of a serious fatigue failure in service.

In some instances, it may be desirable to verify the loadings used in the analyses by flight load and strain surveys.

B. *Typical loading spectrum expected in service.* The loading spectrum should be based on measured statistical data of the type derived from government and industry load history studies, and where insufficient data are available, a conservative estimate of the anticipated use of the aircraft. The principal loads to be considered in establishing a loading spectrum for the flight structure are:

1. Flight loads—gust and maneuver.
2. Ground loads—taxiing, landing impact, turning, engine runup, braking.
3. Pressurization loads.
4. Other loads—ground-air-ground cycle, vibratory.

The development of the loading spectrum requires the definition of the expected flight

plan which involves climb, cruise, descent, flight times, operational speeds and altitudes, the approximate percentage of time to be spent in each of the operating regimes, and any other pertinent effects, such as dynamic overstress and the stress decay characteristics of a flexible structure excited by turbulence.

For pressure cabins, the typical loading spectrum should include the repeated application of the normal operating pressure, and the superimposed effects of flight loads and external aerodynamic pressures. A recommended source of information in the development of a loading spectrum is the *Aircraft Fatigue Handbook, Volume I—Environmental Conditions*, published by the Aircraft Industries Association.

*C. Fatigue analysis.* Some better-known methods for structural fatigue evaluation are briefly outlined in the *Aircraft Fatigue Handbook, Volume II—Design and Analysis*, published by the Aircraft Industries Association. Experience with these methods indicates that no one method is wholly satisfactory in yielding accurate or consistently reliable results, but that in many cases they may be used as approximations in design. Any method used in the fatigue analysis should be supported by test or service experience.

*D. Components to be analyzed and tested.* In assessing the possibility of serious fatigue failure, the design should be carefully examined to determine possible points of failure in service. In this examination, consideration should be given to the results of stress analyses, static tests, strain gage surveys, tests of similar structural configurations, and service experience. Service experience has shown that special attention should be focused on the design details of important discontinuities, main attach fittings, tension joints and splices, and cutouts such as windows, doors, and other openings.

Unless it is determined from the foregoing examination that the normal operating stresses at critical regions in the structure are of such a low order that the possibility of serious fatigue damage is extremely remote, repeated load tests should be conducted on complete full-scale components such as the wing, control surfaces, and pressure cabin. In any event, it is advisable that repeated load tests be con-

ducted on representative portions of the complete flight structure.

Test specimens for the wing and empennage should include attachment fittings, major joints, changes in section, tensile area cutouts, and discontinuities. Test specimens for a pressure fuselage should include the cockpit area; typical joints; a sufficient part of the cabin area to include typical windows, doors, and other cutouts; and the pressure bulkheads and attachments.

*E. Life determination-scatter.* The main purpose of the fatigue tests is to establish for the first and subsequent failures, the component involved and its corresponding fatigue life. If possible, the structure should be repaired after each failure until a stage is reached where further repair is impossible or further testing is considered unnecessary.

In the interpretation of fatigue test data, the effect of variability should be accounted for by an appropriate factor. Relating of such factors to the recommended service life is extremely difficult as there are a number of considerations peculiar to each design that require evaluation by the applicant. The factor will depend on the number of representative test specimens, the material, the type of specimen employed, the type of repeated load test, the load levels, and environmental conditions.

*F. Replacement times.* Parts should be replaced or retired at the established reliable service period unless additional data indicate that an extension of the service period is possible. Important factors in the consideration of such extensions would be:

1. *Satisfactory service experience.* Satisfactory service experience includes establishing from the history of operation of the aircraft that no significant or premature fatigue failure has occurred.
2. *Recorded load data.* Recorded load data entails instrumenting aircraft in service to obtain a representative sampling of actual loads experienced. The data measured should include airspeed, altitude, and load factor versus time; or the airspeed, altitude, and strain ranges versus time, or similar data. The data obtained by instrumenting aircraft in service should provide a basis

for correlating the estimated loading spectrum with the actual service experience.

3. *Additional analyses and tests.* If test data and analyses based on repeated load tests of additional specimens are obtained, a reevaluation of the initial scatter factor may be made.
4. *Tests of parts removed from service.* Repeated load tests of replaced parts may be utilized to reevaluate the initial scatter factor selected. The tests should closely simulate service loading conditions. Repeated load testing of parts removed from service is especially useful where recorded load data obtained in service are available, since the actual loading experienced by the part prior to replacement is known.
5. *Repair or rework of the structure.* In some cases, repair or rework of the structure may gain further service life.

*G. Type design developments and changes.* For design developments or changes involving structural configurations similar to those of a design already shown to comply with the provisions of CAR 4b.270 (a), it may be possible to evaluate the variations in critical portions of the structure on a comparative basis. Typical examples would be redesign of the wing structure for increased loads, and the introduction of different locations and/or shapes of cutouts in pressure cabins. This evaluation involves analysis of the estimated stresses of the redesigned primary structure and correlation of the analysis with the analytical and test results obtained in showing compliance of the original design with CAR 4b.270 (a).

## Section II.—FAIL-SAFE STRENGTH EVALUATION

*A. General.* The fail-safe strength evaluation of the flight structure is intended to insure that should a serious fatigue failure occur, the remaining structure can withstand reasonable flight loads without excessive structural deformation. The fail-safe evaluation generally encompasses establishing the components which are to be made fail-safe, defining the loading conditions and extent of damage for which the structure is to be designed, conducting struc-

tural tests and analyses to substantiate that the design objective has been achieved, and establishing inspection programs aimed at detection of fatigue damage. Design features which may be used in attaining a fail-safe structure are:

1. Use of multipath construction and the provision of crack stoppers to limit the growth of cracks.
2. Use of composite duplicate structures so that a fatigue failure occurring in one-half of the composite member will be confined to the failed half and the remaining structure will still possess appreciable load-carrying ability.
3. Use of backup structure wherein one member carries all the load, with a second member available and capable of assuming the extra load if the primary member fails.
4. Selection of materials and stress levels that provide a controlled slow rate of crack propagation combined with high residual strength after initiation of cracks.
5. Arrangement of design details to permit easy detection of failures in all critical structural elements before the failures can become dangerous or result in appreciable strength loss, and to permit replacement or repair.

*B. Identification of principal structural elements.* Principal structural elements are those which contribute significantly to carrying flight and pressurization loads and whose failure could result in catastrophic failure of the aircraft. Typical examples of such elements are:

1. *Wing and empennage*—
  - a. Control surface attachment hinges and fittings.
  - b. Integrally stiffened plates.
  - c. Primary fittings.
  - d. Principal splices.
  - e. Skin or reinforcement around cutouts or discontinuities.
  - f. Skin-stringer combinations.
  - g. Spar cap.
  - h. Spar web.
2. *Fuselage*.—
  - a. Circumferential frame and adjacent skin.
  - b. Door frames.

- c. Pilot window post.
- d. Pressure bulkheads.
- e. Skin and any single frame or stiffener element around a cutout.
- f. Skin and/or skin splices under circumferential loads.
- g. Skin and/or skin splices under fore-and-aft loads.
- h. Skin around a cutout.
- i. Skin and stiffener combination under fore-and-aft loads.
- j. Window frames.

C. *Extent of fail-safe damage.* Each particular design should be carefully assessed to establish appropriate damage criteria. In any fatigue damage determination, when it is not possible to establish the extent of damage in terms of an "obvious partial failure," the damage should be considered in terms of the complete failure of the single element involved. Thus, an obvious partial failure can be considered to be the extent of the fail-safe damage, provided a positive determination is made that the fatigue cracks will propagate in the open; for example, cracks that occur in exterior skins and which can be detected by a visual inspection at an early stage of the crack development. In a pressurized fuselage, an obvious partial failure can be verified through the inability of the cabin to maintain operating pressure or controlled decompression after occurrence of the damage.

Typical examples of the fatigue damage which should be considered are outlined below:

1. Skin cracks emanating from the edge of structural openings or cutouts which can be readily detected by visual inspection of the area.
2. A circumferential or longitudinal skin crack in the basic fuselage structure of such a length that it can be readily detected by visual inspection of the surface area.
3. Complete severance of interior frame elements or stiffeners in addition to a visually detectable crack in the adjacent skin.
4. Failure of one element where dual construction is utilized in components such as spar caps, window posts, window or door frames, and skin structure.
5. The presence of a fatigue failure in at least the tension portion of the spar web or similar elements.
6. Failure of primary attachments, including control surface hinges and fittings.

D. *Inaccessible areas.* In cases where inaccessible or blind areas are unavoidable, emphasis should be placed on determining crack propagation and residual strength of the particular fatigue-damaged structure in order to assure continued airworthiness of the structure with reasonable inspection methods and controls by the operator. Alternative procedures would be to provide additional fatigue strength to preclude fatigue cracking in the blind element or to conduct fatigue tests of the blind areas to establish that a high service life is provided.

E. *Testing of principal structural elements.* The nature and extent of tests on complete structures and/or portions of the primary structure will depend upon previous experience with similar types of structures regarding tests of this nature and the crack propagation characteristics of the structure. Single elements or members such as stringers, spar caps, and frames should be completely severed and 1.15 times the critical fail-safe load applied after severing. In cases where definite evidence is furnished that the dynamic failure effects are not present, the 1.15 factor may be eliminated or reduced in accordance with the effects noted. Alternatively, the fail-safe loads may be applied to the structure before severing and the 1.15 factor omitted.

In the case of distributed members such as a sheet-stringer combination or an integrally stiffened tension skin, a cut may be made to represent an initial crack in the element under test. If there is no failure, the length of the cut may be increased and the fail-safe load applied until either:

1. The fail-safe damage has been simulated, or
2. The crack propagation rate decreases due to redistribution of load paths, or
3. The crack propagation stops due to a crack stopper.

The simulated cracks should be as representative as possible of actual fatigue damage. In cases where it is not practical to produce

actual fatigue cracks, damage may be simulated by cuts made with a fine saw, sharp blades, or a guillotine. In those cases where it is necessary to simulate damage at joints or fittings, bolts may be removed to simulate the failure if this condition would be representative of an actual failure.

F. *Analysis of principal structural elements.* In some instances, the fail-safe characteristics may be shown analytically. The analytical approach may be used when the structural configuration involved is essentially similar to one already verified by fail-safe tests, whether conducted on a previously approved type design, or whether conducted on other similar areas of the design currently being evaluated.

The analytical approach may also be used when conservative failures are assumed such that the failure would be detected considerably before the critical crack length is approached, and margins of safety resulting from the analysis are well in excess of the fail-safe residual static strength level. In any such analysis, the 1.15 factor should be included unless it can be shown, as indicated in section II H, that this factor is not required.

G. *Selection of a critical area.* Single principal structural elements and detail design points requiring investigation are identified under section II B. The process of actually locating where fail-safe damage should be simulated in an element, such as a wing spar chord or fuselage frame, requires use of sound engineering judgment that takes into account a variety of factors, such as:

1. Conducting an analysis to locate areas of maximum stress and low margin of safety.

2. Conducting strain gage surveys on undamaged structure to establish points of high stress concentration as well as the magnitude of such concentration.
3. Examining static test results to determine locations where excessive deformations occurred.
4. Determining from repeated load tests where failure may have initiated or where the crack propagation rate is a maximum.
5. Selecting locations in an element (such as a spar cap) where the stresses in adjacent elements (such as the spar web or wing skin) would be the maximum with the spar failed.
6. Selecting points in an element (such as a spar web or frame) wherein high stress concentrations are present in the residual structure with the web failed.
7. Assessing detail design areas which service experience records of similarly designed components indicate are prone to fatigue damage.

H. *Dynamic effects.* The dynamic magnification factor of 1.15 should be applied to all loads, including pressure cabin loads, unless fail-safe tests are performed under load, or the dynamic effects are shown to be negligible by dynamic test data from a similar structure.

I. *Inspection.* Detection of fatigue cracks before they become dangerous is the ultimate control in insuring the fail-safe characteristics of the flight structure. Therefore, the aircraft manufacturer should provide sufficient guidance information to assist operators in establishing the frequency and extent of the repeated inspections of the critical structure.



# Appendix I

## ENVIRONMENTAL TEST PROCEDURES: ELECTRICAL EQUIPMENT

(Refer to CAM 4b.625-1)

### A. TEST EQUIPMENT STANDARDS

1. *Test facilities.*—The apparatus used in conducting the tests described in this Appendix should be capable of producing the specified environmental conditions. The equipment under test should not occupy more than 50 percent of the volume of the test chamber. Heat sources should be disposed so that radiant heat does not fall directly on the equipment under test.

2. *Measurement tolerances.*—Allowable tolerances on test condition measurements are as follows:

- (a) *Temperature.*—Plus or minus 4° F.
- (b) *Altitude.*—Plus or minus 5 percent.
- (c) *Humidity.*—Plus or minus 5 percent relative.
- (d) *Vibration amplitude.*—Plus or minus 5 percent.
- (e) *Vibration frequency.*—Plus or minus 2 percent.

3. *Standard room conditions.*—Room conditions for conducting the equipment functional performance check (specified in par. B1) should be as follows:

- (a) *Temperature.*—77° plus or minus 18° F.
- (b) *Relative humidity.*—90 percent or less.
- (c) *Barometric pressure.*—28 to 32 inches of mercury.

4. *Temperature stabilization.*—Temperature stabilization may be checked by a temperature sensing device in good thermal contact with the largest centrally-located internal mass in the equipment under test.

### B. BASIS FOR EVALUATION OF ENVIRONMENTAL TEST RESULTS

1. *Functional performance.*—Before conducting any of the tests described in Section C, the equipment should be operated under standard

room conditions (refer to par. A3) and a record made of all data necessary to demonstrate satisfactory functional performance in all respects affecting safety. This record constitutes the reference performance level for equipment undergoing the environmental tests in Section C. Failure to achieve this reference performance, in any respect significant to safety, denotes failure to meet the environmental test to which the equipment was subjected.

2. *Deterioration.*—Deterioration or corrosion of any internal or external components which could in any manner prevent the continued safe operation of the equipment during its service life would constitute failure to meet the environmental test to which the equipment was subjected.

### C. TEST PROCEDURES

1. *High temperature test.* The equipment should be placed within the test chamber and the internal temperature of the chamber raised to 160° F. with an internal relative humidity of not more than 5 percent. The item of equipment should be maintained at 160° F. for a period of 50 hours. While still at this temperature, the equipment should be operated and the results checked against the data obtained in paragraph B1. The temperature should then be reduced to prevailing room conditions and a visual examination conducted in accordance with paragraph B2.

2. *Low temperature tests.*—

- (a) *Method I.*—The item of equipment should be placed within the test chamber and the chamber cooled to and maintained at a temperature of -65° F. until temperature stabilization (see par. A4) of the equipment is reached. While at this temperature,

the equipment should be operated and the results checked against the data obtained in paragraph B1.

- (b) *Method II (alternate to Method I).*—The equipment should be placed within the test chamber and the chamber cooled to and maintained at a temperature of  $-80^{\circ}$  F. for a period of 48 hours, at which time the equipment should be examined in accordance with paragraph B2. The temperature of the chamber should then be raised to  $-65^{\circ}$  F. and maintained for an additional 24-hour period, or until temperature stabilization is reached (see par. A4), whichever is the longer. At the conclusion of this exposure period and while at this temperature, the equipment should be operated and the results checked against the data obtained in paragraph B1 and visually examined in accordance with paragraph B2.

### 3. Temperature shock tests.—

- (a) *Method I.*—The equipment should be placed within a test chamber wherein a temperature of  $185^{\circ}$  F. is maintained. The equipment should be subjected to this temperature for a period of 4 hours, at the conclusion of which, and within 5 minutes, the equipment should be transferred to a chamber having an internal temperature of  $-40^{\circ}$  F. The equipment should be subjected to this temperature for a period of 4 hours. This completes one cycle. The equipment may be restored to room temperature before starting the next cycle. The number of complete cycles should be three. At the conclusion of the third cycle, the equipment should be removed from the test chamber and within a period of 1 hour operated and the results checked against the data obtained in paragraph B1. A visual examination should then be completed in accordance with paragraph B2.
- (b) *Method II (alternate to Method I).*—The equipment should be placed with-

in the test chamber and maintained for a period of at least 1 hour or until the equipment performance stabilizes at a temperature of  $77^{\circ} \pm 27^{\circ}$  F. The chamber temperature should then be reduced to  $-67^{\circ}$  F. and maintained at this condition for at least 1 hour or until the equipment performance stabilizes. The internal temperature of the chamber should then be increased to  $160^{\circ}$  F. and maintained at this condition for at least 1 hour or until the equipment performance stabilizes. The internal temperature should then be returned to  $77^{\circ} \pm 27^{\circ}$  F. and the performance of the equipment checked against data obtained in paragraph B1.

### 4. Humidity tests.—

- (a) *Method I.*—The equipment should be placed in the test chamber and set up to simulate installed conditions. The chamber temperature should be between  $68^{\circ}$  F. and  $100^{\circ}$  F. with uncontrolled humidity. During the first 2-hour period the temperature should be gradually raised to  $160^{\circ}$  F. The  $160^{\circ}$  F. temperature should be maintained during the next 6-hour period. During the following 16-hour period, the temperature in the chamber should be gradually reduced to between  $68^{\circ}$  F. and  $100^{\circ}$  F., which constitutes one cycle. The relative humidity throughout the cycle should be 95 percent. The cycle should be repeated a sufficient number of times to extend the total time of the test to 240 hours (10 cycles). At the conclusion of the 240-hour period, the equipment should be operated and the data checked against that obtained in paragraph B1, and a visual examination made in accordance with paragraph B2. Distilled or demineralized water having a pH value of between 6.5 and 7.5 at  $77^{\circ}$  F. should be used to obtain the desired humidity. The velocity of the air throughout the test area should not exceed 150 feet per minute.
- (b) *Method II (alternate to Method I).*—The equipment should be placed in the

test chamber and set up to simulate installed conditions. The temperature and relative humidity in the chamber should be 120° F. and 95 percent respectively. The test conditions should be maintained for 360 hours. At the conclusion of this period, the equipment should be operated and the results checked against those obtained in paragraph B1. An examination in accordance with paragraph B2 should then be made.

5. *Altitude test.*—The equipment should be placed within the test chamber and the internal pressure of the chamber reduced to correspond to an altitude exceeding by 15 percent the maximum altitude to which the equipment would be exposed in normal service. The ambient temperature in the chamber (irrespective of test altitude) should be -65° F. The equipment should be maintained at this condition until temperature stabilized (see par. A4). While at this condition, the equipment should be operated and the results checked against those obtained in paragraph B1.

6. *Vibration tests.*—

(a) *Method I (Apply to items of equipment which mount directly on the structure of aircraft powered by reciprocating, turbo-jet or turbo-propeller engines and to items of equipment which mount directly on gas turbine engines).*—The test specimen should be mounted on the apparatus in a manner which is dynamically similar to the most severe condition likely to be encountered in service. The test specimen should be performing its function during the entire test period whenever practicable. At the end of the test period, the test specimen should be inspected thoroughly for damage or defects resulting from the vibration tests. The amplitude or acceleration for the frequency cycling test should be within  $\pm 10$  percent of the specified values. Vibration tests should be conducted under both resonant and cycling conditions according to the following vibration test schedule (table 1):

Table 1.—VIBRATION TEST SCHEDULE

Type	Vibration at—		
	Room temp.	160° F.	-65° F.
Resonance.....	(Min-utes) 60	(Min-utes) 15	(Min-utes) 15
Cycling.....	60	15	15

NOTE: Times shown refer to one axis of vibration.

(i) *Resonance.*—Resonant frequencies of the test specimen should be determined by varying the frequency of applied vibration slowly through the specified range of frequencies at vibratory accelerations not exceeding those shown in figure 1. Individual resonant frequency surveys should be conducted with vibration applied along each of any set of three mutually perpendicular axes of the test specimen. Whenever practicable, functioning of the test specimen should be checked (against the data obtained in par. B1) concurrently with the operation of scanning the frequency range for resonant frequencies. The test specimen should be vibrated at the indicated resonant conditions for the periods shown in the vibration test schedule (table 1) and with the applied double amplitude or vibratory acceleration specified in figure 1. These periods of vibration should be accomplished with vibration applied along each of three mutually perpendicular axes of vibration. When more than one resonant frequency is encountered with vibration applied along any one axis, the test period may be accomplished at the most severe resonance or the period may be divided among

the resonant frequencies, whichever is considered most likely to produce failure. However, in no instance should the specimen be vibrated on any resonant mode for periods less than half as long as those shown for resonance in the vibration test schedule. When resonant frequencies are not apparent within the specified frequency range, the specimen should be vibrated for periods twice as long as those shown for resonance in the vibration test schedule (table 1) at a frequency of 55 cps. and an applied double amplitude of 0.060 inch.

- (ii) *Cycling*.—For test specimens mounted on vibration isolators, a vibration test should be conducted with a constant applied double amplitude of 0.060 inch and the frequency cycling between 10 and 55 cps. in 1-minute cycles. Vibration should be applied along each of three mutually perpendicular axes according to the vibration test schedule (table 1). For specimens which are to be installed in aircraft without vibration isolators, a vibration test should be conducted with the frequency cycling between 10 and 500 cps. in 15-minute cycles at an applied double amplitude of 0.036 inch or an applied acceleration of  $\pm 10g$ , whichever is the limiting value. Vibration should be applied along each of three mutually perpendicular axes according to the vibration test schedule (table 1).

- (b) *Method II (Apply to items of equipment which mount directly to reciprocating engines)*.—The test specimen should be mounted on the apparatus in

a position dynamically similar to the most severe mounting likely to be used in service. Resonant frequencies of the test specimen should be determined by varying the frequency of applied vibration slowly through the specified frequency range at vibratory accelerations not exceeding those shown in figure 1. Individual resonant frequency surveys should be conducted with vibration applied along each of any set of three perpendicular axes of the test specimen. Whenever practicable, the functioning of the test specimen should be checked (against the data obtained in par. B1) concurrently with the operation of scanning the frequency range for resonant frequencies. If resonant frequencies are encountered, the test specimen should be vibrated successively along each of three mutually perpendicular axes for 4 hours at the resonant conditions with the applied double amplitude or vibratory acceleration shown in figure 1. When more than one resonant frequency is encountered with vibration applied along any one axis, the test period may be carried out at the most severe resonance, or the period may be divided uniformly among the resonant frequencies, whichever procedure is considered most likely to produce failure. When clearly defined resonant frequencies are not encountered within the specified frequency range, the test specimen should be vibrated for 12 hours along each of its mutually perpendicular axes at an applied double amplitude of 0.018 inch and a frequency of 150 cycles per second. The test specimen should be performing its function during the entire test period whenever practicable. At the end of the test period the test specimen should be inspected thoroughly for damage or defects resulting from the vibration tests.

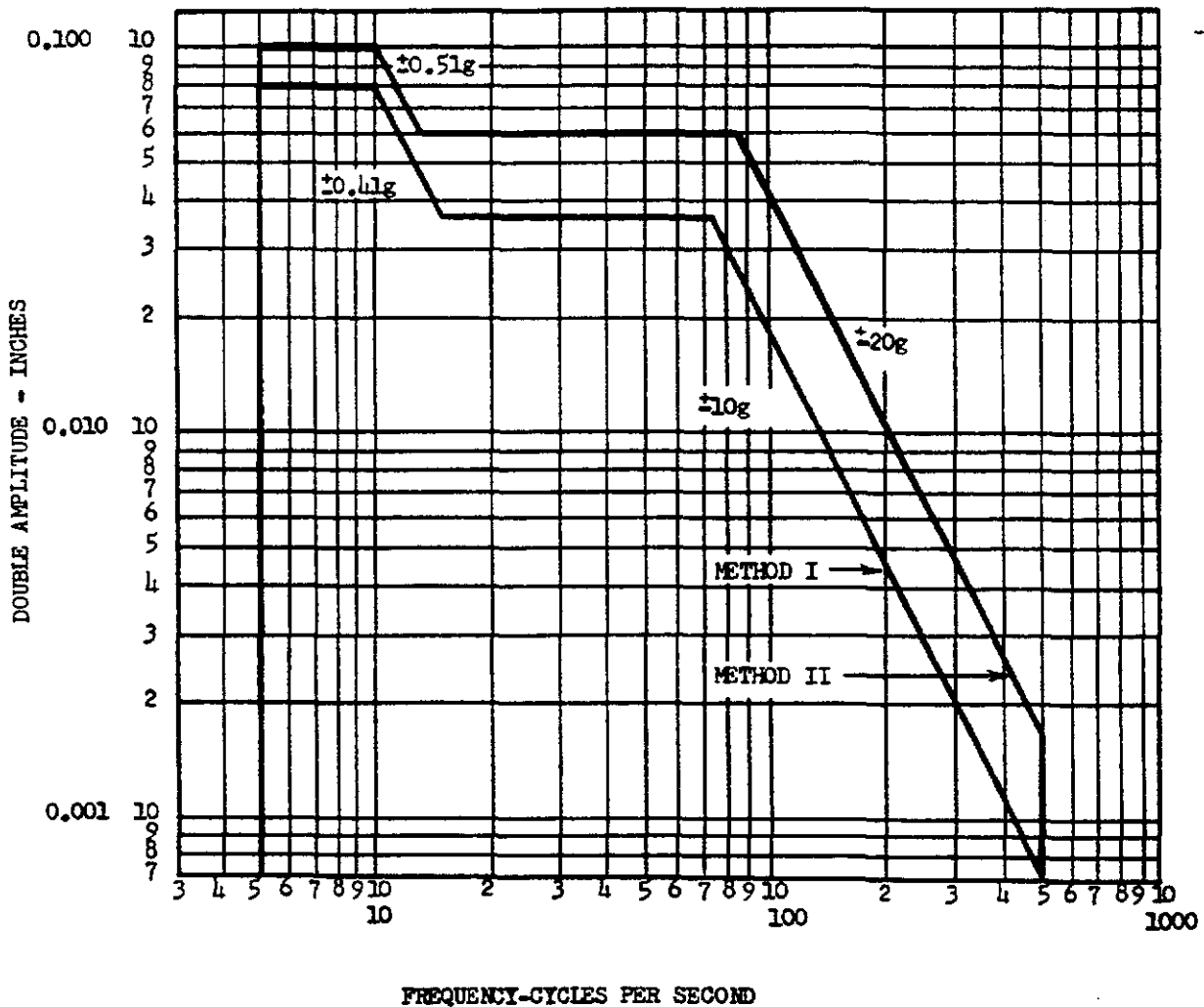

Figure 1.—Range curves for vibration tests.

7. *Fungus resistance test.*—Five groups of fungi are listed below, and one species of fungus from each group should be used. In the preparation of the spore suspension, distilled water having a pH value between 5.8 and 7.2 at temperatures between 72° F. and 89° F. should be used. Approximately 10 ml. of distilled water should then be introduced directly into a tube culture of the fungus and the spores brought into suspension by vigorous shaking or by gentle rubbing of the spore layer with an inoculating loop without disturbing the agar surface. This process is repeated for each species of fungus. The separate spore suspensions from the five species of fungi should

be mixed together to provide a composite suspension. Actively sporulating cultures between 7 and 21 days old after initial inoculation should be used for the preparation of the spore suspension. After preparation the spore suspension should not be kept for more than a 24-hour period at temperatures between 72° F. and 89° F. and not more than 48 hours at refrigerator temperatures of 35° F. to 45° F. The equipment, including applicable external connections, should be placed in a chamber maintaining an internal temperature of 86° ± 3.6° F. and a relative humidity of 95 ± 5 percent, and sprayed with the suspension of mixed spores. The test period should be 28 days. At

the end of the test period the test item should be examined visually in accordance with paragraph B2.

(a) *Organisms.*—

- Group I— *Chaetomium globosum*  
USDA 1042.4 or  
*Myrothecium verrucaria*  
USDA 1334.2
- Group II— *Rhizopus nigricans* S. N.  
32 or  
*Aspergillus niger* USDA  
Tc215-4247
- Group III— *Aspergillus flavus* WADC  
No. 26 or  
*Aspergillus terreus*  
PQMD 82J
- Group IV— *Penicillium luteum*  
USDA 1336.1,  
*Penicillium sp.* USDA  
1336.2, or  
*Penicillium citrinum*  
ATCC 9849
- Group V— *Memnoniella echinata*  
WADC No. 37 or  
*Fusarium moniliforme*  
USDA 1004.1

(b) *Stock culture designations and sources.*—

<i>Symbols</i>	<i>Source</i>
USDA	U. S. Dept. of Agriculture, Beltsville, Md.
ATCC	American Type Culture Collection, 2029 M Street, NW., Washington 6, D. C.
PQMD	Philadelphia Q. M. Depot, 2800 South 20th Street, Philadelphia, Pa.
WADC	Wright Air Development Center, Materials Laboratory, Wright-Patterson Air Force Base, Ohio.
S.N.	Dr. W. B. Weston, Biological Laboratories, Harvard University, Cambridge, Mass.

8. *Salt spray test.*—

(a) *Apparatus.*—Apparatus used in the salt spray test should include the following:

- (i) Exposure chamber with racks for supporting specimens.
- (ii) Salt solution reservoir.
- (iii) Means for atomizing salt solution, including suitable nozzles and compressed air supply.
- (iv) Chamber heating means and control.
- (v) Means for humidifying the compressed air at a temperature above the chamber temperature.

(b) *Chamber.*—The chamber and all accessories should be made of material which will not affect the corrosiveness of the fog, such as glass, hard rubber, plastic, or wood other than plywood. In addition, all parts which come in contact with test items should be of materials that will not cause electrolytic corrosion. The chamber and accessories should be so constructed and arranged that there is no direct impinging of the spray or dripping of the condensate on the test items, that the spray circulates freely about all items to the same degree and that no liquid which has come in contact with the test specimens returns to the salt solution reservoir. The chamber should be properly vented.

(c) *Atomizers.*—The atomizers used should be of such design and construction as to produce a finely divided, wet, dense fog.

(d) *Air supply.*—The compressed air entering the atomizers should be free from all impurities such as oil and dirt. Means should be provided to humidify and warm the compressed air as required to meet the operating conditions. The air pressure should be suitable to produce a finely divided dense fog with the atomizer or atomizers used. To insure against clogging the atomizers by salt deposition, the air should have a relative humidity of

at least 85 percent at the point of release from the nozzle. A satisfactory method is to pass the air in very fine bubbles through a tower containing heated water. The temperature of the water should be 95° F. and often higher. The permissible temperature increases with increasing volume of air and with decreasing heat insulation of the chamber and temperature of its surroundings. It should not exceed a value above which an excess of moisture is introduced into the chamber (for example, 109° F. at an air pressure of 12 psi) or a value which makes it impossible to meet the requirement for operating temperature.

(e) *Salt solution.* The salt used should be sodium chloride containing on the dry basis not more than 0.1 percent of sodium iodide and not more than 0.2 percent of total impurities. The solution should be prepared by dissolving  $20 \pm 2$  parts by weight of salt in 80 parts by weight of distilled or other water containing not more than 200 parts per million of total solids. The solution should be kept free from solids by filtration or decantation. The solution should be adjusted to and maintained at a specific gravity of from 1.126 to 1.157 and at a pH of between 6.5 to 7.2 when measured at a temperature between 92° F. and 97° F. Only C. P. hydrochloric acid or C. P. sodium hydroxide should be used to adjust the pH. The pH measurement should be made electrometrically using a glass electrode with a saturated potassium chloride bridge or by a colorimetric method such as bromothynol blue provided the results are equivalent to those obtained with the electrometric method.

(f) *Operating conditions.*—

(i) *Temperature.*—The test should be conducted with a temperature in the exposure zone maintained at 95° F. Satisfactory methods for controlling the

temperature accurately are by housing the apparatus in a properly controlled constant-temperature room, by thoroughly insulating the apparatus and preheating the air to the proper temperature prior to atomization and by jacketing the apparatus and controlling the temperature of the water or of the air used. Immersion heaters should not be used to maintain the temperature within the chamber.

(ii) *Atomization.*—The conditions maintained in all parts of the exposure zone should be such that a suitable receptacle placed at any point in the exposure zone will collect from 0.5 to 3 ml. of solution per hour for each 30 sq. cm. of horizontal collecting area (10 cm. diameter) based on an average of at least 16 hours. The solution thus collected shall have a sodium chloride content of from 18 to 22 percent (specific gravity of from 1.126 to 1.157 when measured at a temperature between 91.4 and 96.8° F.). At least two clean fog collecting receptacles should be used, one placed nearest to any nozzle and one farthest from all nozzles. Receptacles should be fastened so that they are not shielded by specimens and so that no drops of solution from specimens or other sources will be collected. When using nozzles made of material non-reactive to the salt solution, suitable atomization has been obtained in boxes having a volume of less than 12 cubic feet with the following conditions: Nozzle pressure between 12 and 18 pounds per square inch; orifices between 0.02 and 0.03

## **Addendum**

### **Preambles of Amendments to Civil Air Regulations Part 4b**

#### **NOTE**

**Part 4b of the Civil Air Regulations was last published by the Civil Aeronautics Board December 31, 1953. This was not a general revision of the part, but only a recapitulation of the part to incorporate outstanding amendments. It was not published in the Federal Register.**



## Amendment 4b-1

### Miscellaneous Amendments

Adopted: Apr. 13, 1954

Effective: May 18, 1954

Published: Apr. 20, 1954

(19 F.R. 2249)

A study of the administrative portions of Part 4b of the Civil Air Regulations indicates that they do not set forth in sufficient detail and clarity the scope of the part and the choice of regulations applicable to issuance of and changes in type certificates. This has caused some difficulty in the administration of the regulations with respect to these matters. This amendment is concerned mainly with setting forth clearly the scope of the part, section 4.0, and those regulations that are applicable to the issuance of and change to a type certificate. It also makes several other changes.

Although no basic change in policy from that followed in the past is contemplated, this amendment specifies in more detail the prerogatives of the applicant in choosing the regulations. It should be noted that the rules regarding the designation of applicable regulations, section 4b.11, apply not only to a new airplane type for which application for type certificate is made but also to all types irrespective of the date of original application for a type certificate. For example, the provisions which require, or which permit the applicant to elect, compliance with newer regulations would be effective not only to new type airplanes but also to all existing types certificated under this part. This provision in no way negates the long standing rule that, except in unusual cases, the airplane need not comply with any regulations made effective subsequent to the date of application for a type certificate. A significant clarification is being made which defines those changes in an airplane type which are sufficiently extensive to warrant treating it as a new type. Another important change is the establishment of a time limitation of 5 years for the effectiveness of an application for type certification. The amendments to the other administrative provisions, sections 4.12, 4.13, and 4.19, also include minor changes for purposes of clarification.

The presently effective regulations provide for the location of the pilot and his controls and instruments with respect to the plane of rotation of the propellers, etc. Since in certain instances the airworthiness regulations require flight crew personnel in addition to the pilot, these provisions (sections 4b.350, 4b.351, and 4b.353) are being amended to make them applicable to the minimum flight crew which is required for safe operation of the airplane.

Part 4b does not contain specific criteria for the installation of reversible propeller control systems. This amendment adds section 4b.407 which requires the application of the principle of fail-safe design to propeller reversing systems in newly certificated transport category airplanes. The intent of the rule is to preclude unwanted reversing of the propeller during normal or emergency operation in case of a single failure or malfunction of the system. It is also intended that single failures or malfunctions be considered in conjunction with manipulation of the controls by the pilot, and that failure of primary structural parts, the occurrence of which is expected to be extremely remote, need not be considered.

A change is being made to the requirements which establish the power supply needed for operation of equipment, systems, and installations during normal and power failure conditions. The change makes clear that the essential power load requirements under power failure conditions may be reduced in conjunction with a monitoring procedure and, for the two-engine-inoperative condition, permits taking into account for power supply requirements only those loads which are necessary for controlled flight.

Several additional changes of relatively minor nature are being made with the intent of clarifying the regulations.

Interested persons have been afforded an opportunity to participate in the making of this amendment, and due consideration has been given to all relevant matter presented.

### Amendment made the following changes:

- (1) Amended sections 4b.0, 4b.11, 4b.12, 4b.13, 4b.19, 4b.350, 4b.351, 4b.353, 4b.362, 4b.604, and 4b.606; and
- (2) Added section 4b.407.

## Amendment 4b-2

## Miscellaneous Amendments

Adopted: July 20, 1955  
Effective: Aug. 25, 1955  
Published: July 26, 1955  
(20 F.R. 5303)

This amendment includes a number of significant changes which are considered to represent the initial step in the development of airworthiness requirements more specifically applicable to turbine-powered transport category airplanes. These entail revisions to the flight, structural, and powerplant installation provisions and in most cases are generally applicable to transport category airplanes, irrespective of the type of powerplant used. The most significant changes in the flight provisions which cater to turbine-powered airplanes deal with the establishment of limiting climb speeds for the all-engine-operating landing configuration in section 4b.119 and for the one-engine-inoperative approach configuration in section 4b.120. No limiting speeds are prescribed for these configurations in the currently effective regulations. In view of the fact that the best climb speeds for jet-powered airplanes might be considerably higher than the operational landing speed, these changes are designed to assure a reasonable relationship between the climb speeds and the landing speed. Other revisions of the flight provisions include changes in the take-off speed requirements of section 4b.114, in the trim requirements of sections 4b.141 and 4b.142, and in the stability requirements of sections 4b.154 and 4b.155.

Among the changes in the structural requirements is a new provision in section 4b.216(a) which is more specifically applicable to turbine-propeller-powered airplanes. It prescribes taking into account the high torque which might occur from possible unwanted feathering of a propeller under full power.

In addition there are other changes to the structural provisions which are generally applicable. These involve a requirement in new section 4b.216(d) which prescribes consideration of the unsymmetrical tail loads which might be caused by propeller drag as a result of possible time delay between engine failure and feathering of the propeller, a requirement in section 4b.210(b)(4) allowing the applicant to limit  $V_0$  at altitudes where  $V_a$  is limited by Mach number, and a requirement in section 4b.231(a) which prescribes an investigation of the landing gear for loads resulting from the higher contact speeds at altitudes and during downwind landings when the approval of landings above 5,000 feet or landings in downwinds exceeding 10 mph, respectively, is sought.

There are included amendments with respect to the installation of smoke detectors in cargo compartments. The currently effective rules in Part 4b require the installation of smoke detectors in cargo compartments "B", "C", and "D". In addition, the currently effective provisions in the air carrier operating parts of the Civil Air Regulations require, on all passenger airplanes with engines of over 600 horsepower, the installation of smoke detectors in "B" and "C" compartments. On the other hand, pending further development of reliable smoke detectors, Special Civil Air Regulation No. SR-401 permits noncompliance with the smoke detector provisions in Part 4b and in the operating parts of the regulations until April 1, 1956. This amendment revises sections 4b.383 (b)(2), (c)(1)(i), and (d), so that heat-type fire detectors may be installed in lieu of smoke detectors in compartments "B" and "C" and no detectors need be installed in compartments "D." Concurrently with this amendment, Parts 40, 41, and 42 are being amended so that heat-type fire detectors may be installed in lieu of smoke detectors in compartments "B" and "C."

A number of significant changes are included in connection with the powerplant installation requirements for the purpose of making them more specifically applicable to turbine-powered airplanes. In this regard changes are made to sections 4b.460, b4.480, b4.483, 4b.486, 4b.488, and 4b.490. These changes entail several new provisions designed mainly for the protection against fire in turbine powerplant installations. They include provisions against overflow of combustible fluids in the induction system, provisions which specify the compressor and accessory section of the turbine engine as designated fire zones, and provisions making certain requirements of the presently effective regulations for designated fire zones applicable to the combustion, turbine, and tail pipe sections.

In addition, section 4b.640 is being amended to incorporate a comprehensive and detailed set of standards intended to provide protection in types of icing conditions which might be reasonably anticipated during normal operations.

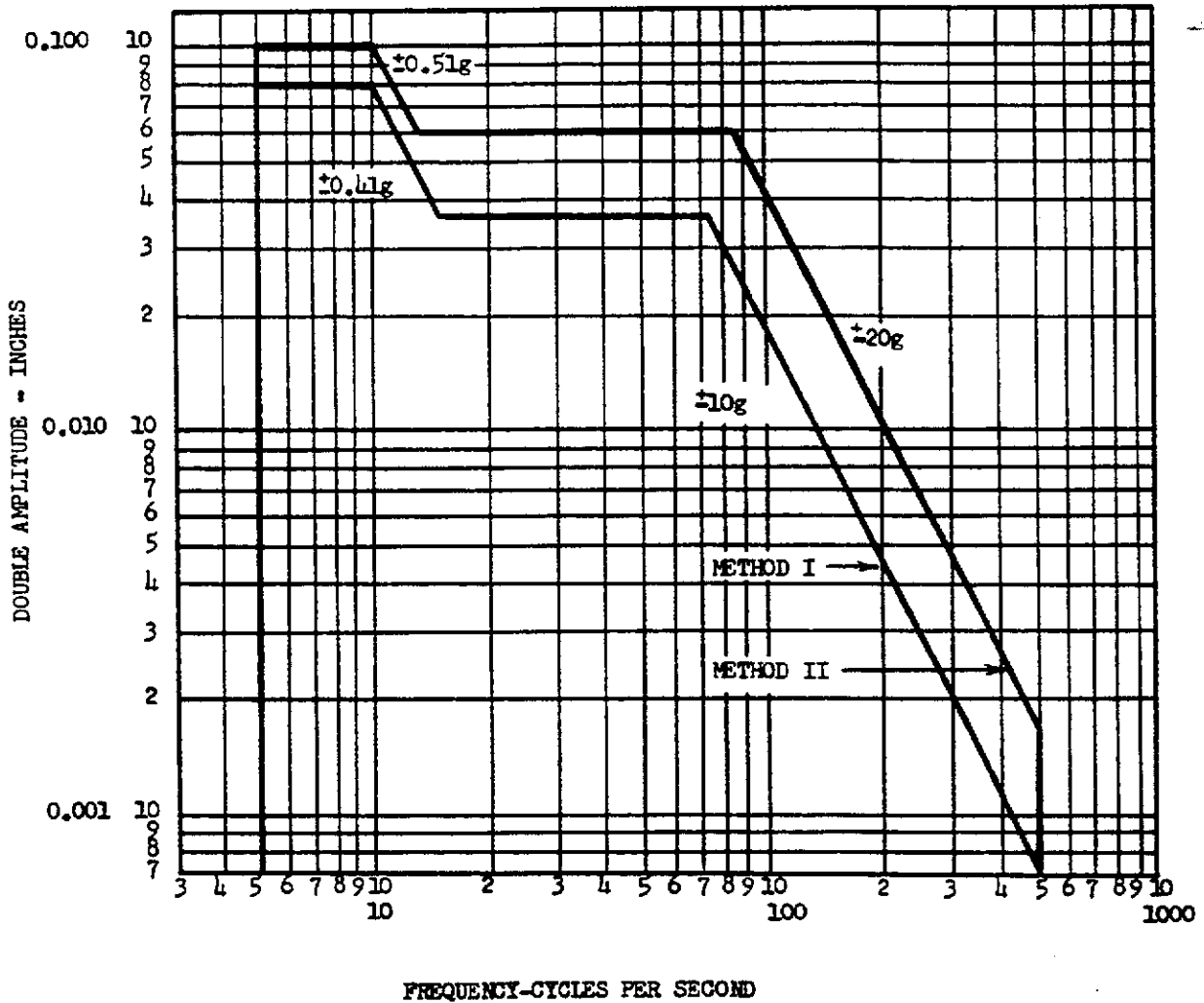

Figure 1.—Range curves for vibration tests.

7. *Fungus resistance test.*—Five groups of fungi are listed below, and one species of fungus from each group should be used. In the preparation of the spore suspension, distilled water having a pH value between 5.8 and 7.2 at temperatures between 72° F. and 89° F. should be used. Approximately 10 ml. of distilled water should then be introduced directly into a tube culture of the fungus and the spores brought into suspension by vigorous shaking or by gentle rubbing of the spore layer with an inoculating loop without disturbing the agar surface. This process is repeated for each species of fungus. The separate spore suspensions from the five species of fungi should

be mixed together to provide a composite suspension. Actively sporulating cultures between 7 and 21 days old after initial inoculation should be used for the preparation of the spore suspension. After preparation the spore suspension should not be kept for more than a 24-hour period at temperatures between 72° F. and 89° F. and not more than 48 hours at refrigerator temperatures of 35° F. to 45° F. The equipment, including applicable external connections, should be placed in a chamber maintaining an internal temperature of 86° ± 3.6° F. and a relative humidity of 95 ± 5 percent, and sprayed with the suspension of mixed spores. The test period should be 28 days. At

the end of the test period the test item should be examined visually in accordance with paragraph B2.

(a) *Organisms.*—

Group I— *Chaetomium globosum*  
USDA 1042.4 or

*Myrothecium verrucaria*  
USDA 1334.2

Group II— *Rhizopus nigricans* S. N.  
32 or

*Aspergillus niger* USDA  
Tc215-4247

Group III— *Aspergillus flavus* WADC  
No. 26 or

*Aspergillus terreus*  
PQMD 82J

Group IV— *Penicillium luteum*  
USDA 1336.1,

*Penicillium sp.* USDA  
1336.2, or

*Penicillium citrinum*  
ATCC 9849

Group V— *Memnoniella echinata*  
WADC No. 37 or

*Fusarium moniliforme*  
USDA 1004.1

(b) *Stock culture designations and sources.*—

Symbols	Source
USDA	U. S. Dept. of Agriculture, Beltsville, Md.
ATCC	American Type Culture Collection, 2029 M Street, NW., Washington 6, D. C.
PQMD	Philadelphia Q. M. Depot, 2800 South 20th Street, Philadelphia, Pa.
WADC	Wright Air Development Center, Materials Laboratory, Wright-Patterson Air Force Base, Ohio.
S.N.	Dr. W. B. Weston, Biological Laboratories, Harvard University, Cambridge, Mass.

8. *Salt spray test.*—

(a) *Apparatus.*—Apparatus used in the salt spray test should include the following:

- (i) Exposure chamber with racks for supporting specimens.
- (ii) Salt solution reservoir.
- (iii) Means for atomizing salt solution, including suitable nozzles and compressed air supply.
- (iv) Chamber heating means and control.
- (v) Means for humidifying the compressed air at a temperature above the chamber temperature.

(b) *Chamber.*—The chamber and all accessories should be made of material which will not affect the corrosiveness of the fog, such as glass, hard rubber, plastic, or wood other than plywood. In addition, all parts which come in contact with test items should be of materials that will not cause electrolytic corrosion. The chamber and accessories should be so constructed and arranged that there is no direct impinging of the spray or dripping of the condensate on the test items, that the spray circulates freely about all items to the same degree and that no liquid which has come in contact with the test specimens returns to the salt solution reservoir. The chamber should be properly vented.

(c) *Atomizers.*—The atomizers used should be of such design and construction as to produce a finely divided, wet, dense fog.

(d) *Air supply.*—The compressed air entering the atomizers should be free from all impurities such as oil and dirt. Means should be provided to humidify and warm the compressed air as required to meet the operating conditions. The air pressure should be suitable to produce a finely divided dense fog with the atomizer or atomizers used. To insure against clogging the atomizers by salt deposition, the air should have a relative humidity of

at least 85 percent at the point of release from the nozzle. A satisfactory method is to pass the air in very fine bubbles through a tower containing heated water. The temperature of the water should be 95° F. and often higher. The permissible temperature increases with increasing volume of air and with decreasing heat insulation of the chamber and temperature of its surroundings. It should not exceed a value above which an excess of moisture is introduced into the chamber (for example, 109° F. at an air pressure of 12 psi) or a value which makes it impossible to meet the requirement for operating temperature.

(e) *Salt solution.* The salt used should be sodium chloride containing on the dry basis not more than 0.1 percent of sodium iodide and not more than 0.2 percent of total impurities. The solution should be prepared by dissolving  $20 \pm 2$  parts by weight of salt in 80 parts by weight of distilled or other water containing not more than 200 parts per million of total solids. The solution should be kept free from solids by filtration or decantation. The solution should be adjusted to and maintained at a specific gravity of from 1.126 to 1.157 and at a pH of between 6.5 to 7.2 when measured at a temperature between 92° F. and 97° F. Only C. P. hydrochloric acid or C. P. sodium hydroxide should be used to adjust the pH. The pH measurement should be made electrometrically using a glass electrode with a saturated potassium chloride bridge or by a colorimetric method such as bromothynol blue provided the results are equivalent to those obtained with the electrometric method.

(f) *Operating conditions.*—

(i) *Temperature.*—The test should be conducted with a temperature in the exposure zone maintained at 95° F. Satisfactory methods for controlling the

temperature accurately are by housing the apparatus in a properly controlled constant-temperature room, by thoroughly insulating the apparatus and preheating the air to the proper temperature prior to atomization and by jacketing the apparatus and controlling the temperature of the water or of the air used. Immersion heaters should not be used to maintain the temperature within the chamber.

(ii) *Atomization.*—The conditions maintained in all parts of the exposure zone should be such that a suitable receptacle placed at any point in the exposure zone will collect from 0.5 to 3 ml. of solution per hour for each 30 sq. cm. of horizontal collecting area (10 cm. diameter) based on an average of at least 16 hours. The solution thus collected shall have a sodium chloride content of from 18 to 22 percent (specific gravity of from 1.126 to 1.157 when measured at a temperature between 91.4 and 96.8° F.). At least two clean fog collecting receptacles should be used, one placed nearest to any nozzle and one farthest from all nozzles. Receptacles should be fastened so that they are not shielded by specimens and so that no drops of solution from specimens or other sources will be collected. When using nozzles made of material non-reactive to the salt solution, suitable atomization has been obtained in boxes having a volume of less than 12 cubic feet with the following conditions: Nozzle pressure between 12 and 18 pounds per square inch; orifices between 0.02 and 0.03

inch in diameter; atomization of approximately 3 quarts of the salt solution per 10 cubic feet of box volume per 24 hours. When using large size boxes having a volume considerably in excess of 12 cubic feet, these conditions may have to be modified to meet the requirements for operating conditions.

(iii) *Preparation of equipment.*—The equipment should be mounted in the chamber and electrical and mechanical connections completed where operation is required during the test period. Access covers and inspection plates should be in place except when such covers would normally be removed for service use. When operation is not required, external connections may be plugged to simulate actual service conditions.

(g) *Conclusion.*—The length of the salt spray test should be not less than 50 hours. At the end of the test period, the equipment should be operated and the results checked against the data obtained in paragraph B1. Salt deposits resulting from the test conditions may be removed prior to operation. A visual examination should be conducted in accordance with paragraph B2.

9. *Sand and dust tests.*—The equipment should be placed within the test chamber and the sand and dust density raised and maintained at 0.1 to 0.5 grams per cubic foot within the test space. The relative humidity should not exceed 30 percent at any time during the test. Sand and dust used in the test should be of angular structure and should have characteristics as follows:

- (a) 100 percent of the sand and dust should pass through a 100-mesh screen, U. S. Standard Sieve Series.
- (b)  $98 \pm 2$  percent of the sand and dust should pass through a 140-mesh screen, U. S. Standard Sieve Series.

- (c)  $90 \pm 2$  percent of the sand and dust should pass through a 200-mesh screen, U. S. Standard Sieve Series.
- (d)  $75 \pm 2$  percent of the sand and dust should pass through a 325-mesh screen, U. S. Standard Sieve Series.
- (e) Chemical analysis of the dust should be as follows:

<i>Substance</i>	<i>Percent by Weight</i>
SiO <sub>2</sub> .....	97 to 99
Fe <sub>2</sub> O <sub>3</sub> .....	0 to 2
Al <sub>2</sub> O <sub>3</sub> .....	0 to 1
TiO <sub>2</sub> .....	0 to 2
MgO.....	0 to 1
Ign Losses.....	0 to 2

The internal temperature of the test chamber should be maintained at 77° F. for a period of 6 hours with sand and dust velocity through the test chamber between 100 and 500 feet per minute. After 6 hours at these conditions, the temperature should be raised to and maintained at 160° F. These conditions should be maintained for 6 hours. At the end of this test period, the equipment should be removed and allowed to cool to room temperature. When cooled to room temperature, the equipment should be operated and the results checked against those obtained in paragraph B1. An examination in accordance with paragraph B2 should be conducted.

10. *Shock test.*—The equipment should be subjected to the shock conditions as normally used in service, including any shock mount assembly. A shock testing machine conforming to Military Specification MIL-S-4456 is suitable for this test.

The test specimen should be subjected to 18 impact shocks of 10g, each shock impulse having a time duration of  $11 \pm 1$  milliseconds. The intensity should be within  $\pm 10$  percent when measured with a filter having a band width of 5 to 100 cycles per second. The maximum g should be reached in approximately  $5\frac{1}{2}$  milliseconds. The shock should be applied in the following directions:

- (a) Vertically, 3 shocks in each direction.
- (b) Parallel to the major horizontal axis, 3 shocks in each direction.
- (c) Parallel to the minor horizontal axis, 3 shocks in each direction.

The test specimen should not suffer damage.

The equipment should be operated and the results checked against those obtained in paragraph B1. An examination in accordance with paragraph B2 should be conducted.

11. *Acceleration test.*—The test specimen should be mounted on the apparatus (centri-

fuge) successively in three positions so that each of the three major axes of the test specimen in turn extend in a radial direction with respect to the centrifuge center of rotation. A 15g acceleration should be attained, stabilized, and maintained for a period of not less than one minute for each position. Functional tests should be conducted during application of the acceleration to assure that safe performance (refer to par. B1) of the equipment is obtained. There should be no mechanical failures or malfunctions due to the applied acceleration.

## **Addendum**

### **Preambles of Amendments to Civil Air Regulations Part 4b**

#### **NOTE**

**Part 4b of the Civil Air Regulations was last published by the Civil Aeronautics Board December 31, 1953. This was not a general revision of the part, but only a recapitulation of the part to incorporate outstanding amendments. It was not published in the Federal Register.**



## Amendment 4b-1

### Miscellaneous Amendments

Adopted: Apr. 13, 1954

Effective: May 18, 1954

Published: Apr. 20, 1954

(19 F.R. 2249)

A study of the administrative portions of Part 4b of the Civil Air Regulations indicates that they do not set forth in sufficient detail and clarity the scope of the part and the choice of regulations applicable to issuance of and changes in type certificates. This has caused some difficulty in the administration of the regulations with respect to these matters. This amendment is concerned mainly with setting forth clearly the scope of the part, section 4.0, and those regulations that are applicable to the issuance of and change to a type certificate. It also makes several other changes.

Although no basic change in policy from that followed in the past is contemplated, this amendment specifies in more detail the prerogatives of the applicant in choosing the regulations. It should be noted that the rules regarding the designation of applicable regulations, section 4b.11, apply not only to a new airplane type for which application for type certificate is made but also to all types irrespective of the date of original application for a type certificate. For example, the provisions which require, or which permit the applicant to elect, compliance with newer regulations would be effective not only to new type airplanes but also to all existing types certificated under this part. This provision in no way negates the long standing rule that, except in unusual cases, the airplane need not comply with any regulations made effective subsequent to the date of application for a type certificate. A significant clarification is being made which defines those changes in an airplane type which are sufficiently extensive to warrant treating it as a new type. Another important change is the establishment of a time limitation of 5 years for the effectiveness of an application for type certification. The amendments to the other administrative provisions, sections 4.12, 4.13, and 4.19, also include minor changes for purposes of clarification.

The presently effective regulations provide for the location of the pilot and his controls and instruments with respect to the plane of rotation of the propellers, etc. Since in certain instances the airworthiness regulations require flight crew personnel in addition to the pilot, these provisions (sections 4b.350, 4b.351, and 4b.353) are being amended to make them applicable to the minimum flight crew which is required for safe operation of the airplane.

Part 4b does not contain specific criteria for the installation of reversible propeller control systems. This amendment adds section 4b.407 which requires the application of the principle of fail-safe design to propeller reversing systems in newly certificated transport category airplanes. The intent of the rule is to preclude unwanted reversing of the propeller during normal or emergency operation in case of a single failure or malfunction of the system. It is also intended that single failures or malfunctions be considered in conjunction with manipulation of the controls by the pilot, and that failure of primary structural parts, the occurrence of which is expected to be extremely remote, need not be considered.

A change is being made to the requirements which establish the power supply needed for operation of equipment, systems, and installations during normal and power failure conditions. The change makes clear that the essential power load requirements under power failure conditions may be reduced in conjunction with a monitoring procedure and, for the two-engine-inoperative condition, permits taking into account for power supply requirements only those loads which are necessary for controlled flight.

Several additional changes of relatively minor nature are being made with the intent of clarifying the regulations.

Interested persons have been afforded an opportunity to participate in the making of this amendment, and due consideration has been given to all relevant matter presented.

#### Amendment made the following changes:

- (1) Amended sections 4b.0, 4b.11, 4b.12, 4b.13, 4b.19, 4b.350, 4b.351, 4b.353, 4b.362, 4b.604, and 4b.606; and
  - (2) Added section 4b.407.
-

## Amendment 4b-2

## Miscellaneous Amendments

Adopted: July 20, 1955

Effective: Aug. 25, 1955

Published: July 26, 1955

(20 F.R. 5303)

This amendment includes a number of significant changes which are considered to represent the initial step in the development of airworthiness requirements more specifically applicable to turbine-powered transport category airplanes. These entail revisions to the flight, structural, and powerplant installation provisions and in most cases are generally applicable to transport category airplanes, irrespective of the type of powerplant used. The most significant changes in the flight provisions which cater to turbine-powered airplanes deal with the establishment of limiting climb speeds for the all-engine-operating landing configuration in section 4b.119 and for the one-engine-inoperative approach configuration in section 4b.120. No limiting speeds are prescribed for these configurations in the currently effective regulations. In view of the fact that the best climb speeds for jet-powered airplanes might be considerably higher than the operational landing speed, these changes are designed to assure a reasonable relationship between the climb speeds and the landing speed. Other revisions of the flight provisions include changes in the take-off speed requirements of section 4b.114, in the trim requirements of sections 4b.141 and 4b.142, and in the stability requirements of sections 4b.154 and 4b.155.

Among the changes in the structural requirements is a new provision in section 4b.216(a) which is more specifically applicable to turbine-propeller-powered airplanes. It prescribes taking into account the high torque which might occur from possible unwanted feathering of a propeller under full power.

In addition there are other changes to the structural provisions which are generally applicable. These involve a requirement in new section 4b.216(d) which prescribes consideration of the unsymmetrical tail loads which might be caused by propeller drag as a result of possible time delay between engine failure and feathering of the propeller, a requirement in section 4b.210(b)(4) allowing the applicant to limit  $V_c$  at altitudes where  $V_d$  is limited by Mach number, and a requirement in section 4b.231(a) which prescribes an investigation of the landing gear for loads resulting from the higher contact speeds at altitudes and during downwind landings when the approval of landings above 5,000 feet or landings in downwinds exceeding 10 mph, respectively, is sought.

There are included amendments with respect to the installation of smoke detectors in cargo compartments. The currently effective rules in Part 4b require the installation of smoke detectors in cargo compartments "B", "C", and "D". In addition, the currently effective provisions in the air carrier operating parts of the Civil Air Regulations require, on all passenger airplanes with engines of over 600 horsepower, the installation of smoke detectors in "B" and "C" compartments. On the other hand, pending further development of reliable smoke detectors, Special Civil Air Regulation No. SR-401 permits noncompliance with the smoke detector provisions in Part 4b and in the operating parts of the regulations until April 1, 1956. This amendment revises sections 4b.383 (b)(2), (c)(1)(i), and (d), so that heat-type fire detectors may be installed in lieu of smoke detectors in compartments "B" and "C" and no detectors need be installed in compartments "D." Concurrently with this amendment, Parts 40, 41, and 42 are being amended so that heat-type fire detectors may be installed in lieu of smoke detectors in compartments "B" and "C."

A number of significant changes are included in connection with the powerplant installation requirements for the purpose of making them more specifically applicable to turbine-powered airplanes. In this regard changes are made to sections 4b.460, b4.480, b4.483, 4b.486, 4b.488, and 4b.490. These changes entail several new provisions designed mainly for the protection against fire in turbine powerplant installations. They include provisions against overflow of combustible fluids in the induction system, provisions which specify the compressor and accessory section of the turbine engine as designated fire zones, and provisions making certain requirements of the presently effective regulations for designated fire zones applicable to the combustion, turbine, and tail pipe sections.

In addition, section 4b.640 is being amended to incorporate a comprehensive and detailed set of standards intended to provide protection in types of icing conditions which might be reasonably anticipated during normal operations.

There is also included an amendment which changes section 4b.740 so that each airplane need not be furnished with an Airplane Flight Manual if such a manual is not required by the operating parts of the Civil Air Regulations. Concurrently with this amendment, Parts 40, 41, and 42 are being amended to require the carriage of an approved Airplane Flight Manual only when the airplane does not carry an operators' manual containing all the information as required for the Airplane Flight Manual.

In addition to the foregoing substantive changes, there are included a number of miscellaneous minor changes most of which are editorial or of a clarifying nature.

Interested persons have been afforded an opportunity to participate in the making of this amendment (20 F.R. 339), and due consideration has been given to all relevant matter presented.

**Amendment made the following changes:**

- (1) Amended sections 4b.1, 4b.114, 4b.119, 4b.120, 4b.141, 4b.142, 4b.154, 4b.155, 4b.210, 4b.212, 4b.216, 4b.221, 4b.226, 4b.231, 4b.356, 4b.373, 4b.383, 4b.386, 4b.401, 4b.404, 4b.417, 4b.418, 4b.420, 4b.460, 4b.480, 4b.481, 4b.483, 4b.484, 4b.486, 4b.487, 4b.488, 4b.489, 4b.490, 4b.610, 4b.612, 4b.632, 4b.634, 4b.640, 4b.643, 4b.712, 4b.732, and 4b.740, and the Notice under figure 4b-20;
- (2) Deleted sections 4b.455, 4b.456, and 4b.457; and
- (3) Added figures 4b-24a, 4b-24b, 4b-24c, 4b-25a, 4b-25b, and 4b-25c.

---

**Amendment 4b-3**

**Miscellaneous Amendments Resulting From  
the 1955 Annual Airworthiness Review**

**Adopted: Feb. 7, 1956  
Effective: Mar. 13, 1956  
Published: Feb. 11, 1956  
(21 F.R. 989)**

There are contained herein amendments with respect to various issues which resulted from the 1955 Annual Airworthiness Review.

With respect to the flight provisions, section 4b.112 is being amended to permit the use of the minimum speed attained during the stall demonstration in determining the required climb and section 4b.160 is being amended to permit determination of the demonstration stall speed in terms of the stall warning speed.

The currently effective gust load requirements are based on wing loading. Research in past years indicated that gust loads are more closely a function of mass parameter than of wing loading. For this reason, there is being included an amendment incorporating the more up-to-date concept of "mass parameter" in the gust load requirements.

In new section 4b.270 there is included a rule which establishes more specific criteria for fatigue evaluation of flight structure, including pressurized cabins. Among other amendments relative to the structural provisions there is a change to section 4b.210(c) which establishes more realistic criteria for evaluating the strength of the airplane at weights in the vicinity of the zero fuel weight. The new criteria for zero fuel weight are applicable only in conjunction with the application of the new gust load and fatigue evaluation criteria. There are also included amendments which require accounting for compressibility effects at all speeds, the establishment of detailed conditions for the evaluation of gyroscopic loads imposed on engine mounts, and consideration of thermal effects on the structure.

There is an amendment to section 4b.230(b) which permits, in showing compliance with the ground load requirements, the use of wing lift equal to the weight of the airplane instead of only two-thirds of the weight as is prescribed by the currently effective regulations. To compensate for the relaxatory effect of this amendment, other complementary changes are being made in several of the other ground load requirements.

Three changes are being made with respect to provisions pertaining to control surfaces and their control systems. Two of these entail changes to section 4b.320 which require incorporation of design features or the marking of control system elements to minimize the possibility of incorrect assembly and which require tab control system designs to be such

that a failure of any element would not jeopardize the safety of flight. The third change is to section 4b.324 which requires application of the fail safe philosophy to flap actuating systems incorporating a mechanical interconnection to assure against hazardous unsymmetrical flap extension.

There is included a change to section 4b.336 which establishes more up-to-date criteria for the selection of landing gear tires.

The currently effective requirements of section 4b.358 with respect to the restraining of occupants in berths by safety belts are considered unrealistic. A change in these provisions is being made, which excludes safety belts in berths from compliance with the forward inertia load prescribed for emergency landings, and instead, requires that such load with respect to berth occupants be reacted by means of a padded end board, a canvas diaphragm, or other equivalent means.

In addition, there are included other changes which are relatively minor, clarifying, or of an editorial nature.

Interested persons have been afforded an opportunity to participate in the making of this amendment (20 F.R. 8350), and due consideration has been given to all relevant matter presented.

**Amendment made the following changes:**

- (1) Amended sections 4b.104, 4b.112, 4b.160, 4b.202, 4b.210, 4b.211, 4b.212, 4b.213, 4b.215, 4b.216, 4b.230, 4b.231, 4b.232, 4b.235, 4b.306, 4b.320, 4b.324, 4b.332, 4b.336, 4b.337, 4b.358, 4b.386, 4b.413, 4b.414, 4b.420, 4b.421, 4b.424, 4b.430, 4b.431, 4b.435, 4b.437, 4b.451, 4b.604, 4b.637, 4b.643, 4b.711, 4b.718, and 4b.738, and figures 4b-1, 4b-3, 4b-8, 4b-9, 4b-10, and 4b-11; and
- (2) Added sections 4b.234a and 4b.270.

---

**Amendment 4b-4**

**Position and Anticollision Light  
Requirements**

Adopted: Feb. 25, 1957  
Effective: Apr. 1, 1957  
Published: Mar. 1, 1957  
(22 F.R. 1273)

The continuing increase in air traffic density and the advent of airplanes capable of appreciably higher speeds than heretofore attained demand further improvement in the exterior lighting of aircraft. The presently effective regulations in Part 4b of the Civil Air Regulations prescribe certain specifications for anticollision lights and, in addition, require the installation of a position light flasher and prescribe certain specifications for position lights.

The presently effective specifications for anticollision lights contained in section 4b.637 were established a few years ago. They were based upon conclusions reached from experimentation and studies conducted by both industry and government. The use on a relatively large number of aircraft of lights conforming to these specifications has revealed the need for further modification. Furthermore, during the past year or so experimentation has led to the development of condenser-discharge type lights which appear to have certain advantageous features. The inherent characteristics of such lights, however, do not permit compliance with certain of the specifications presently contained in section 4b.637. The Board considers that both incandescent and condenser-discharge lights have sufficient advantages to permit their use, provided that the design features essential in an effective anticollision light system are incorporated. Accordingly, section 4b.637 is being amended to include new specifications which establish in more detail the essential features of an anticollision light and which at the same time are sufficiently broad to permit the use of new lights currently under development.

Experience with anticollision lights has shown that the relatively high intensity of these lights may have a deleterious effect on the visibility of the position lights, particularly if the

latter are flashing. Apparently the flashing of wing and tail position lights, the fuselage lights, and the anticollision lights is conducive to confusion as regards the direction of flight. Tests have shown that with the presently used system the clearest indication is obtained when, in addition to the flashing anticollision light, the lighting system is limited to two wing lights and a white tail light, and when these three position lights are on steady. In view of the foregoing, the provisions of section 4b.632 which require fuselage lights, red tail light, and the flasher are being deleted. Concurrently with this amendment, Part 40 of the Civil Air Regulations is being amended to delete the provision for flashing position lights.

These new specifications for anticollision and position lights will be applicable to all transport category airplanes for which application for type certification is made after the effective date of this amendment. However, the new lighting system may be installed on current airplanes on a voluntary basis.

It is considered that these new requirements set forth necessary and sufficient conditions for anticollision light systems to provide a reasonable level of safety. However, since these requirements entail more conditions than have been required in the past, experience with them on individual airplanes might indicate the need for future revisions, particularly with respect to light intensities and coverage. Further, as current research and development programs progress, the question of color of the light might need reevaluation. The Board will consider any necessary changes as might be indicated by future developments.

Interested persons have been afforded as opportunity to participate in the making of this amendment (21 F.R. 3388), and due consideration has been given to all relevant matter presented.

**Amendment made the following changes:**

- (1) Amended sections 4b.632, 4b.634, and 4b.637, and figures 4b-18 and 4b-20; and
- (2) Added figure 4b-27.

---

**Amendment 4b-5**

**Emergency Evacuation Provisions**

Adopted: Mar. 5, 1957  
 Effective: Apr. 9, 1957  
 Published: Mar. 9, 1957  
 (22 F.R. 1546)

The presently effective emergency evacuation provisions contained in section 4b.362 of Part 4b of the Civil Air Regulations were adopted on November 15, 1951, and were considered appropriate for airplanes which were then in the design stage. Airplanes currently undergoing development are considerably larger in passenger capacity; consequently, the emergency evacuation provisions heretofore effective are considered in need of revision. Furthermore, experience with these requirements indicates a need for additional revision to make them more practicable for application to all airplanes subject to these provisions.

This amendment makes certain changes in the number, size, and location of emergency exits. Also, provision is made for a somewhat greater flexibility of application of these regulations. In addition, this amendment prescribes exit configurations for high-wing airplanes, and provides for evacuation means in case of unplanned ditching in water for all airplanes.

Pursuant to the provisions of section 4b.11(c) of Part 4b, an applicant for type certification may elect to show compliance with this amendment even though the date of application for type certification was made prior to the effective date of this amendment. However, it is considered that the provisions of section 4b.362 are so interrelated that if the applicant elects to show compliance with any portion of the section, he should be required to show compliance with the entire section.

Interested persons have been afforded an opportunity to participate in the making of this amendment (21 F.R. 7688), and due consideration has been given to all relevant matter presented.

**Amendment made changes in section 4b.362.**

---

## Amendment 4b-6

Miscellaneous Amendments Resulting From  
the 1956 Annual Airworthiness Review

Adopted: July 8, 1957  
Effective: Aug. 12, 1957  
Published: July 16, 1957  
(22 F.R. 5562)

There are contained herein amendments with respect to various issues stemming from the 1956 Annual Airworthiness Review.

Of the changes being made, the most extensive ones involve the powerplant provisions. Most of these are applicable to turbine engine installations. In this regard, there is included an amendment to section 4b.480 which designates as fire zones combustor, turbine, and tailpipe sections containing lines carrying flammable fluids or gases, but does not require the installation of a fire-extinguisher system in these sections if a fire occurring in any such sections can be demonstrated to be otherwise controlled. In addition, section 4b.485 is being amended to require fire detectors for all combustor, turbine, and tailpipe sections irrespective of whether they contain lines carrying flammable fluids or gases. The currently effective requirements specify the compressor and accessory sections of turbine engines as fire zones and make only certain provisions for fire zones applicable to the other sections. These changes should provide a reasonably high degree of fire protection for turbine powerplants.

Heretofore there have been no specific provisions in the regulations governing engine design for the protection against rotor blade failure. However, concurrently with this amendment Part 13 of the Civil Air Regulations is being amended to require that rotor cases be of such construction as to contain the damage resulting from rotor blade failure. In order to provide the necessary protection on airplanes which might use engines not incorporating this construction, there is included in new section 4b.401(d) a provision to require such protection in the powerplant installation.

Concurrently with this amendment Part 13 is also being amended to minimize the probability of turbine rotor failure by requiring additional design precautions in respect of the turbine wheel and the relevant engine control systems. In this regard, a requirement is included in new section 4b.401(e) to require design precautions in the powerplant installation to safeguard the airplane against turbine rotor failures when the airplane is equipped with engines not certificated in accordance with the criteria in the aforementioned amendment to Part 13.

There is also included a change to section 4b.604 which specifies the required instruments for turbine powerplants. No change is being made with respect to the instruments for reciprocating engines. The requirement for a reverse thrust indicator for turbopropellers specifies early indication instead of either early or late as implied in the currently effective provisions for reciprocating engines. In view of the characteristic operation of the turbopropeller in the ground fine and reverse pitch ranges, it is considered that an early indication would provide the more useful information to the pilots. The requirement for the reverse thrust indicator on turbojet installations specifies indication when the device is in the reverse position. It is intended to permit the use of either an early or a late indication. The Board considers that further study may be necessary on turbo-propeller installations utilizing reverse thrust power and on turbojet reverse thrust systems to determine whether a quantitative type of indicator should be required.

A new provision is being added (section 4b.408) which requires, on turbopropeller installations, the consideration of the single failure safety criterion in the design of propeller-drag limiting systems such as negative torque control systems and other backup systems. This provision is not intended to require consideration of more than one component failure in any one of the systems at any given time, either during normal or emergency operation: investigation of all components, whether or not integral with the engine, is required.

There are included herein changes which extend the currently effective provisions governing intermittent maximum icing conditions so as to cover conditions which might be critical insofar as the turbine engine induction system is concerned. In this regard, the data are being extended in accordance with NACA Technical Note 2738 and involve a revision of Figure 4b-25a to cover drop diameters as low as 15 microns and a revision of Figure 4b-25c to cover distances down to 0.3 mile. The icing conditions prescribed in the currently

effective regulations are applicable in the main to the airframe. The changes being made in section 4b.461 require the turbine powerplant to be subjected to the same icing conditions and require that the induction system be protected to prevent serious engine power loss. A similar requirement is incorporated with respect to certification of turbine engines by an amendment to Part 13 which is being made concurrently with this amendment.

Additional changes to the powerplant provisions include consideration of turbine engine torque, caused by sudden engine stoppage, in the structural design of the engine mount (see section 4b.216(a)(4)); of crash protection for fuselage fuel tanks (see section 4b.420(f)); and of safety criteria for fuel dumping systems (see section 4b.437(f)). It is considered that the storage of fuel in the fuselage section of the wing might pose serious fire hazards during a crash landing and, therefore, in order to minimize these hazards, the provisions in section 4b.420(e) require that fuselage fuel tanks withstand without leakage the inertia forces prescribed in the currently effective regulations for emergency landing conditions. It is not intended by this requirement to prescribe any particular type of fuel tank design.

With respect to section 4b.236 there is being included a more specific requirement to account for the unsymmetrical loads on multiple-wheel landing gears. A change is being made to section 4b.335(c) to permit greater flexibility in determining the required energy capacity for wheel brakes.

With respect to pressurization equipment and supply, section 4b.374 is being changed to require that airplanes equipped with pressurization systems maintain, at the maximum operating altitude under normal conditions, a cabin pressure altitude of not more than 8,000 feet and all airplanes certificated for operation above an altitude of 25,000 feet be able to maintain a cabin pressure altitude of not more than 15,000 feet in the event that any one pressurization system component becomes inoperative. In addition, the oxygen equipment requirements of section 4b.651 are being revised to make them more realistically applicable to airplanes which are intended to operate above 25,000 feet.

In addition, there are other less substantive changes being made with respect to personnel accommodations, emergency evacuation provisions, autopilot systems, etc. Further, there are included other changes which are relatively minor, clarifying, or of an editorial nature.

Interested persons have been afforded an opportunity to participate in the making of this amendment (21 F.R. 9217), and due consideration has been given to all relevant matter presented.

**Amendment made the following changes:**

- (1) Amended sections 4b.1, 4b.210, 4b.212, 4b.216, 4b.235, 4b.236, 4b.270, 4b.320, 4b.335, 4b.337, 4b.352, 4b.353, 4b.356, 4b.358, 4.362, 4b.371, 4b.374, 4b.401, 4b.420, 4b.435, 4b.437, 4b.440, 4b.460, 4b.461, 4b.474, 4b.480, 4b.483, 4b.484, 4b.485, 4b.604, 4b.605, 4b.612, 4b.613, 4b.622, 4b.631, 4b.640, 4b.645, and 4b.651, and figures 4b-11, 4b-25a, and 4b-25c; and
- (2) Added new sections 4b.408 and 4b.474a.

---

**Amendment 4b-7**

**Instrument Installations**

**Adopted:** Sept. 12, 1957  
**Effective:** Oct. 17, 1957  
**Published:** Sept. 19, 1957  
 (22 F.R. 7461)

In 1953 the Civil Aeronautics Board promulgated section 4b.611(b) of Part 4b of the Civil Air Regulations and established a standard arrangement for the location on the instrument panel of required basic flight instruments. This amendment to section 4b.611(b) prescribes a new standard for the arrangement of basic flight instruments.

Studies made by representatives of the Government and industry indicated that the standard prescribed in section 4b.611(b) no longer reflects the optimum instrument arrangement, and does not provide the flexibility needed to include new instruments, or to integrate related instruments, which have been or may be developed in the future. Accordingly, a

proposal to replace the existing standard for flight instrument arrangement with a new one commonly referred to as the "Basic T" was published for comment in accordance with public rule making procedures and circulated as Civil Air Regulations Draft Release No. 57-5 on April 3, 1957.

In this draft release it was proposed to establish a "Basic T" arrangement consisting of a group of 6 instruments giving the following information: (1) speed, (2) attitude, (3) altitude, (4) flight path deviation, (5) direction, and (6) climb. However, after consideration of the comment received in response to the proposal and after further analysis of the problem, the Board has concluded that there are only 4, rather than 6, basic flight instruments that require a standard location on the instrument panel. The 4 instruments are those which present basic information as to air speed, attitude, altitude, and direction.

While it was originally proposed to establish standard positions for those instruments giving information as to flight path deviation and climb, it is believed such a proposal would make the standard so inflexible as to interfere with the possible integration of such instruments with the 4 basic instruments, and the use of newly developed instruments. Accordingly, this amendment prescribes standard positions on the instrument panel for only the 4 instruments which present basic information as to airspeed, attitude, altitude, and direction.

The concept of the "Basic T" involves more than location of specifically named instruments. The theory is that it will constitute a system by which various items of related flight information will be cataloged and placed in certain standard locations in all instrument panels, regardless of type or make of instruments used. In this manner the "Basic T" takes advantage of the new types of integrated instruments which display more than one item of flight information. It is apparent, however, that if the proposed standard is to be a standard in fact, one basic indication must be specified for each instrument position. This eliminates, for example, the possibility of airspeed being replaced by angle of attack under the theory that airspeed is no longer required except for navigational purposes. It appears to be generally agreed that the basic indication of position 1 is airspeed. In this location may be added related flight information such as Mach number and angle of attack. It also appears to be generally agreed that the basic indications for positions 2 and 3 are pitch and bank, and (barometric) altitude. Command signals for adjusting pitch or turning right or left may be added to the attitude instrument (pitch and bank) and similarly, terrain clearance information and rate of climb may be included in position 3 with the altimeter.

Some difference of opinion was registered by interested parties with respect to position 4, previously position 5 in Draft Release 57-5. This instrument has been labeled "direction," and is intended primarily for navigational information. Certain groups have contended that the basic indication for this location should be heading. Their reason is that heading is paramount in maintaining a course, or making good a desired track, and that a gyroscopically stabilized indication of heading logically belongs immediately below the attitude instrument where it can be read simultaneously with the attitude instrument for three-dimensional control of the airplane. Others, on the other hand, contend that there should be a choice left to the operator to place a display for heading, flight path deviation, or both in this location. The reasoning is that certain carriers desire to use an integrated instrument in this position which shows pictorially the airplane's position in reference to a desired track, but not a quantitative indication of heading.

In considering the above issue the Board takes cognizance of the fact that most air transports of today do not have installed a flight path director or steering computer. In these airplanes heading must be read continually to give significance to the signals received from radio navigation aids. Accordingly, heading is the basic indication to be required in position 4. However, with increased use of electronic computers and installation of instruments systems which include command signals to make good required flight tracks there will be less dependence upon heading, and it is possible, therefore, that in the future the basic indication required by the pilot to maintain a given track will not be heading. Consequently, the rule establishes that the number 4 position shall be that instrument which most effectively indicates direction of flight with the understanding that the basic indication of this instrument shall be heading but that if future developments prove it feasible the basic indication of this instrument may be changed so long as it is demonstrated that it is the instrument which most effectively indicates direction of flight. It is believed that this solution is consonant with present and known future aircraft flight instrument systems and will at the same time provide sufficient flexibility to permit use of newer direction instruments if these prove more operationally feasible.



With respect to the specific location of the basic flight instruments, we believe that the attitude (bank and pitch) indicator is the keystone of any instrument arrangement, and should, therefore, be located in the central position on the panel, with the other basic instruments disposed around it. The indicator providing directional information is constantly monitored along with the attitude indicator, in order to provide continuous three-dimensional control of the flight path. Since directional information is associated with the longitudinal axis of the airplane, this instrument should be most naturally positioned centrally beneath the attitude indicator. Control of air speed and altitude are directly related to attitude, so their location laterally adjacent to the attitude indicator is a natural one.

Interested persons have been afforded an opportunity to participate in the making of this amendment (22 F.R. 2538), and due consideration has been given to all relevant matter presented.

Amendment revised section 4b.611(b) and deleted figure 4b-23.

#### Amendment 4b-8

Miscellaneous Amendments Resulting From the 1957  
Annual Airworthiness Review

Adopted: Apr. 15, 1958  
Effective: May 17, 1958  
Published: Apr. 19, 1958  
(23 F.R. 2590)

There are contained herein amendments with respect to various issues stemming from the 1957 Annual Airworthiness Review.

Of the substantive changes, there is a new requirement in section 4b.132(e) which establishes basic objective criteria to insure, for the all-engines-operating condition, adequate lateral control within the operating speed range and appropriate airplane response to control application in all stages of flight. The provisions up to this time did not prescribe any specific requirements in this respect. It is expected that this rule will result in a more effective evaluation of the airplane's lateral stability and controllability.

The fatigue evaluation provisions, although applicable to all of the flight structure, do not specify any loading conditions for vertical flight surfaces with respect to the fail safe strength criteria in section 4b.270(b). For completeness of these provisions, an addition to section 4b.270(b) is contained herein which sets forth ultimate loads, relative to the fail safe strength evaluation of vertical surfaces, in terms of the generally applicable unsymmetrical and maneuvering limit loading conditions now prescribed in the regulations. There is also a change to section 4b.236(c)(2) which prescribes vertical load factors necessary for defining more completely the unsymmetrical loads applicable in the taxiing and ground handling conditions for landing gears of multiwheel units.

Currently effective regulations require trim tab controls to be irreversible unless the tab is properly balanced and is shown to be free from flutter. The regulations do not cover this design feature with respect to other trim devices such as adjustable stabilizers, etc. A change is contained herein to section 4b.322 to require that all trim control systems be free from drift or creep.

There are contained herein several important changes with respect to powerplants. New section 4b.409 requires an in-flight investigation of turbine powerplants with respect to stall, surge, flame-out, etc. Included also is a change to section 4b.435 which establishes more definite specifications for fuel system filtration. In addition, the powerplant operating limitation provisions in section 4b.718 are being revised to make them more specifically applicable to turbine powerplants.

There are included several changes to the provisions regarding personnel accommodations, emergency evacuation, and ditching. The most substantive one involves a change to section 4b.362(d) which would permit the substitution of 2 type IV exits in lieu of each required type III exit, when such exits are intended for ditching.

Changes are being made to the provisions dealing with the landing gear retraction system, section 4b.334(b); with altimeter static pressure source tolerances, section 4b.612(b)(5); and with markings of the airspeed indicator, section 4b.732. A new section 4b.659 is included which requires appropriate protection of the airplane against failure of

## Amendment 4b-10

Cargo Compartment Classification  
"E" for All-Cargo OperationsAdopted: Apr. 17, 1959  
Effective: Apr. 23, 1959  
Published: Apr. 23, 1959  
(24 F.R. 3153)

The presently effective sections 4b.382 and 4b.383 of Part 4b of the Civil Air Regulations prescribe design conditions for the protection of cargo and baggage compartments against fire. These requirements classify compartments into "A," "B," "C," and "D."

Class "A" and "B" compartments are those which provide access to all parts of the compartment to permit the use of hand fire extinguishers. In addition, Class "B" compartments require that all contents therein can be moved by hand. Class "C" and "D" compartments do not have this accessibility. Instead, Class "C" compartments are required to have a fire-extinguishing system capable of effectively flooding the entire compartment. Class "D" compartments are those in which the volume of air and its flow are so limited as to cause suppression of fire as a result of oxygen depletion.

An air carrier engaged in the carriage of cargo exclusively recommended to the Civil Aeronautics Board an amendment of the existing regulations to provide an additional classification of cargo compartments more specifically applicable to bulk loading of the main cabin area of an airplane engaged in all-cargo operations. The carrier indicated that the weight and bulk of the cargo to be carried in the main cabin make its movement by the crew impractical. Furthermore, the loss of cargo space by providing accessibility to all parts of the compartment and its contents results in an unnecessary economic burden. For these reasons, it is not practical to classify the main cabin as either an "A" or "B" compartment. Classification as a "C" compartment, considering the relatively large volume of the cabin, makes it impractical to carry a sufficient quantity of fire-extinguishing agent to flood effectively the entire cabin. Due to the large volume of the cabin, compliance with the conditions set forth for Class "D" compartments also becomes extremely difficult because so much oxygen exists that prompt suppression of the fire through oxygen depletion is not attainable.

The Civil Aeronautics Board included a proposed change to the cargo and baggage compartment fire protection requirements of Part 4b in a notice of proposed rule making issued in Draft Release No. 58-1C, dated December 22, 1958. That proposal, although it appeared to cover the intent, did not define in detail the specific conditions applicable to bulk-loaded cabins. After further study and considering the comments on the draft release, it is found that setting forth specific conditions is necessary. Therefore, the amendment contained herein establishes a new Class "E" cargo compartment and prescribes the detailed design conditions applicable thereto.

An evaluation of Daily Mechanical Reports and air carrier incident reports disclosed that between 1951 and 1956 during 18,971,602 hours of passenger-carrying flight time there had been four inflight fires in baggage compartments. It was reported that one of these fires was attributed to the cargo coming in contact with a cockpit heater, one was caused by matches in a passenger's bag, and two resulted from baggage being loaded against unprotected light bulbs. Additionally, three fires, detected while loading passengers' baggage before departure, were found to be caused by matches in passengers' bags. During this same period, there were no incidents of fire in 572,443 hours of flight in all-cargo operations. In the period 1957-1958, one additional fire was reported in the Daily Mechanical Reports. The cause of this fire was found to have been due to baggage being placed against an unprotected light bulb.

It has been determined that this amendment will make fire prevention requirements for all-cargo aircraft more realistic, without any material reduction in safety. Accordingly, section 4b.383 of Part 4b of the Civil Air Regulations is being amended to provide for all-cargo operations the new Class "E" cargo compartment located in the main cabin of an airplane. Such compartment is required to be equipped with a smoke or fire detector system to warn the crew of smoke or fire, to be completely lined with fire-resistant material, to provide for control of ventilation by the crew within the compartment, and to provide means for excluding hazardous quantities of smoke, flames, or noxious gases from entering the flight crew's compartment. Furthermore, it requires that crew-emergency exits remain accessible under all loading conditions.

With respect to the specific location of the basic flight instruments, we believe that the attitude (bank and pitch) indicator is the keystone of any instrument arrangement, and should, therefore, be located in the central position on the panel, with the other basic instruments disposed around it. The indicator providing directional information is constantly monitored along with the attitude indicator, in order to provide continuous three-dimensional control of the flight path. Since directional information is associated with the longitudinal axis of the airplane, this instrument should be most naturally positioned centrally beneath the attitude indicator. Control of air speed and altitude are directly related to attitude, so their location laterally adjacent to the attitude indicator is a natural one.

Interested persons have been afforded an opportunity to participate in the making of this amendment (22 F.R. 2538), and due consideration has been given to all relevant matter presented.

#### Amendment revised section 4b.611(b) and deleted figure 4b-23.

---

#### Amendment 4b-8

Miscellaneous Amendments Resulting From the 1957 Annual Airworthiness Review	Adopted: Apr. 15, 1958 Effective: May 17, 1958 Published: Apr. 19, 1958 (23 F.R. 2590)
---	---

There are contained herein amendments with respect to various issues stemming from the 1957 Annual Airworthiness Review.

Of the substantive changes, there is a new requirement in section 4b.132(e) which establishes basic objective criteria to insure, for the all-engines-operating condition, adequate lateral control within the operating speed range and appropriate airplane response to control application in all stages of flight. The provisions up to this time did not prescribe any specific requirements in this respect. It is expected that this rule will result in a more effective evaluation of the airplane's lateral stability and controllability.

The fatigue evaluation provisions, although applicable to all of the flight structure, do not specify any loading conditions for vertical flight surfaces with respect to the fail safe strength criteria in section 4b.270(b). For completeness of these provisions, an addition to section 4b.270(b) is contained herein which sets forth ultimate loads, relative to the fail safe strength evaluation of vertical surfaces, in terms of the generally applicable unsymmetrical and maneuvering limit loading conditions now prescribed in the regulations. There is also a change to section 4b.236(c)(2) which prescribes vertical load factors necessary for defining more completely the unsymmetrical loads applicable in the taxiing and ground handling conditions for landing gears of multiwheel units.

Currently effective regulations require trim tab controls to be irreversible unless the tab is properly balanced and is shown to be free from flutter. The regulations do not cover this design feature with respect to other trim devices such as adjustable stabilizers, etc. A change is contained herein to section 4b.322 to require that all trim control systems be free from drift or creep.

There are contained herein several important changes with respect to powerplants. New section 4b.409 requires an in-flight investigation of turbine powerplants with respect to stall, surge, flame-out, etc. Included also is a change to section 4b.435 which establishes more definite specifications for fuel system filtration. In addition, the powerplant operating limitation provisions in section 4b.718 are being revised to make them more specifically applicable to turbine powerplants.

There are included several changes to the provisions regarding personnel accommodations, emergency evacuation, and ditching. The most substantive one involves a change to section 4b.362(d) which would permit the substitution of 2 type IV exits in lieu of each required type III exit, when such exits are intended for ditching.

Changes are being made to the provisions dealing with the landing gear retraction system, section 4b.334(b); with altimeter static pressure source tolerances, section 4b.612(b)(5); and with markings of the airspeed indicator, section 4b.732. A new section 4b.659 is included which requires appropriate protection of the airplane against failure of

high energy rotors when such rotors are incorporated in any equipment on the airplane. There is included an amendment to section 4b.603 which requires the incorporation of a maximum airspeed indicator if the airspeed limitations vary appreciably with altitude.

In addition, there are included other changes which are of a clarifying or editorial nature.

Interested persons have been afforded an opportunity to participate in the making of this amendment (22 F.R. 9116), and due consideration has been given to all relevant matter presented.

Amendment made the following changes:

- (1) Amended sections 4b.1, 4b.132, 4b.236, 4b.270, 4b.322, 4b.334, 4b.358, 4b.362, 4b.435, 4b.603, 4b.612, 4b.651, 4b.718, 4b.732, 4b.741, and 4b.742; and
- (2) Added sections 4b.409 and 4b.659.

---

#### Amendment 4b-9

#### Supplemental Oxygen Requirements

Adopted: Aug. 27, 1958  
Effective: Sept. 1, 1958  
Published: Aug. 30, 1958  
(23 F.R. 6743)

The advent of turbine-powered airplanes with normal operating altitudes higher than has been the case with airplanes powered by reciprocating engines has made necessary a reconsideration of supplemental oxygen requirements. Following a study of this problem by representatives of the Government and industry, a proposal to amend the existing supplemental oxygen requirements of Part 4b and the operating rules was published in accordance with public rule making procedures and circulated as Civil Air Regulations Draft Release No. 58-7 dated March 27, 1958.

In this draft release it was proposed to consolidate all controls, instruments, and warning devices at a single location to permit all phases of monitoring and operation of the pressurization and oxygen systems by a single crewmember. However, after consideration of the comments received the Board has concluded that such requirement, while stating a desirable objective, would actually result in a potentially lower level of safety because of the added complexity that would result. With regard to warning devices, it was proposed also to require both visible and audible warnings to give alarm in the event of cabin depressurization. Comments received in this matter pointed out that, in contrast to past practice, airplanes in the next few years will almost certainly incorporate other audible warning devices that may operate at cruise altitude and require immediate conditioned response, and that confusion could result from providing too many such audible warnings. Considering these comments, the Board concluded that the current requirements in section 4b.375(f) provide for adequately effective warnings.

High rates of fuel consumption at low altitudes lead to the possible necessity for turbine-powered transport airplanes to cruise at altitudes that would require sustaining oxygen for all occupants for extended periods of time. This has emphasized a need for regulations as to the minimum quantity of oxygen which may be carried to insure adequate protection for the passengers. The quantities prescribed by the current requirements of section 4b.651 are generally conceded to be in excess of actual needs for sustenance. The new oxygen flow rates contained herein will provide a level of safety acceptable for sustaining purposes without reducing the quantity carried below a safe minimum.

Some difference of opinion was expressed concerning the provisions for oxygen in the altitude range above 25,000 feet where its main purpose is to prevent physical harm to the passengers following cabin depressurization. One position was that it would be adequate to apply the same prescription as proposed for sustaining oxygen. The opposing view was held that while this might be adequate for sustenance at altitudes above 25,000 feet it would not be satisfactory following cabin decompression at these altitudes because of the problem of removing nitrogen from the lungs, and that for this reason a greater quantity of oxygen should be prescribed. The problem associated with this view is that either the flow rate must be equivalent to the higher requirement throughout the altitude range, or

equipment must be provided to enable the oxygen system to differentiate between two situations. In weighing these opposing views, the Board took into consideration that the prescription in the regulation is a minimum value; that previous requirements, although prescribing a greater quantity of oxygen, have not accounted for overall system efficiency; that additional system complexity would decrease reliability; and that the objective of oxygen following a decompression is to prevent physical harm and not necessarily to provide passengers with the same amount of oxygen which would be available at sea level.

There was some expression of opinion that the flow rate provided for flight crewmembers was not adequate. In considering these opinions, the Board was not able to establish that the 5,000-foot equivalent provided by the prescription for demand-type equipment was unsatisfactory. Consideration was also given to the fact that the prescription is a minimum and that normal operating tolerances will invariably insure that a somewhat greater quantity is furnished. Since this prescription could result in the crew being unable to draw oxygen from the demand-type system while the cabin is pressurized, a requirement is being added that undiluted oxygen be available to the crew.

The provision for insuring that oxygen masks be immediately available to the users is believed to be proper in light of the problems associated with flight at these altitudes. The time available to begin breathing supplemental oxygen becomes less with increasing altitude due to the decrease in the period of useful consciousness. Thus the requirements for making the dispensing units available to the users become more severe as the maximum certificated altitude becomes higher.

A prescription is being added to define the quantity of oxygen to be made available for first-aid use. To avoid having to predict the pressure altitudes at which such will be used, the prescription is in terms of flow at standard temperature and pressure.

The provisions of this regulation require two outlets and units of oxygen-dispensing equipment in the washroom and in the lavatory.

The cabin attendants, in the course of their normal duties, may be at any place in the cabin at the time of depressurization. Since, at the normal cruising altitude of turbine-powered airplanes, sufficient time may not be available for the attendants to return to a designated oxygen station, it is necessary that either a portable oxygen supply be carried by each attendant or that sufficient additional outlets and units of dispensing equipment be immediately available throughout the cabin to insure that it will be attainable at all times. The likelihood of turbine-powered airplanes having to continue operations at flight altitudes requiring sustaining oxygen makes necessary the provision of portable oxygen equipment for cabin attendants in order to insure their mobility even though such equipment may not be required to satisfy the emergency descent provisions. To avoid, as much as possible, the problems associated with changing over from a spare outlet of the installed system to a portable unit, these portable units should have, to the degree practicable, a uniform distribution in the cabin. To provide for this, the portable oxygen units are required to be immediately available.

The proposal regarding means of determining delivery of oxygen to the dispensing units was intended to provide an indication that the oxygen system is in operation and that oxygen is being released from the storage containers to the distribution system. Determination of delivery to individuals, as in the past, by observation of the storage bags on the masks or similar type examinations is felt to be inadequate.

Interested persons have been afforded an opportunity to participate in the making of this amendment (23 F.R. 2229), and due consideration has been given to all relevant matter presented. In view of the imminence of operations to be conducted pursuant to this amendment, the Board finds that further notice and public procedure hereon would be contrary to the public interest and that this amendment may be made effective on less than 30 days' notice.

**Amendment made changes in section 4b.651 and deleted figure 4b-21.**

---

## Amendment 4b-10

Cargo Compartment Classification  
"E" for All-Cargo Operations

Adopted: Apr. 17, 1959  
 Effective: Apr. 23, 1959  
 Published: Apr. 23, 1959  
 (24 F.R. 3153)

The presently effective sections 4b.382 and 4b.383 of Part 4b of the Civil Air Regulations prescribe design conditions for the protection of cargo and baggage compartments against fire. These requirements classify compartments into "A," "B," "C," and "D."

Class "A" and "B" compartments are those which provide access to all parts of the compartment to permit the use of hand fire extinguishers. In addition, Class "B" compartments require that all contents therein can be moved by hand. Class "C" and "D" compartments do not have this accessibility. Instead, Class "C" compartments are required to have a fire-extinguishing system capable of effectively flooding the entire compartment. Class "D" compartments are those in which the volume of air and its flow are so limited as to cause suppression of fire as a result of oxygen depletion.

An air carrier engaged in the carriage of cargo exclusively recommended to the Civil Aeronautics Board an amendment of the existing regulations to provide an additional classification of cargo compartments more specifically applicable to bulk loading of the main cabin area of an airplane engaged in all-cargo operations. The carrier indicated that the weight and bulk of the cargo to be carried in the main cabin make its movement by the crew impractical. Furthermore, the loss of cargo space by providing accessibility to all parts of the compartment and its contents results in an unnecessary economic burden. For these reasons, it is not practical to classify the main cabin as either an "A" or "B" compartment. Classification as a "C" compartment, considering the relatively large volume of the cabin, makes it impractical to carry a sufficient quantity of fire-extinguishing agent to flood effectively the entire cabin. Due to the large volume of the cabin, compliance with the conditions set forth for Class "D" compartments also becomes extremely difficult because so much oxygen exists that prompt suppression of the fire through oxygen depletion is not attainable.

The Civil Aeronautics Board included a proposed change to the cargo and baggage compartment fire protection requirements of Part 4b in a notice of proposed rule making issued in Draft Release No. 58-1C, dated December 22, 1958. That proposal, although it appeared to cover the intent, did not define in detail the specific conditions applicable to bulk-loaded cabins. After further study and considering the comments on the draft release, it is found that setting forth specific conditions is necessary. Therefore, the amendment contained herein establishes a new Class "E" cargo compartment and prescribes the detailed design conditions applicable thereto.

An evaluation of Daily Mechanical Reports and air carrier incident reports disclosed that between 1951 and 1956 during 18,971,602 hours of passenger-carrying flight time there had been four inflight fires in baggage compartments. It was reported that one of these fires was attributed to the cargo coming in contact with a cockpit heater, one was caused by matches in a passenger's bag, and two resulted from baggage being loaded against unprotected light bulbs. Additionally, three fires, detected while loading passengers' baggage before departure, were found to be caused by matches in passengers' bags. During this same period, there were no incidents of fire in 572,443 hours of flight in all-cargo operations. In the period 1957-1958, one additional fire was reported in the Daily Mechanical Reports. The cause of this fire was found to have been due to baggage being placed against an unprotected light bulb.

It has been determined that this amendment will make fire prevention requirements for all-cargo aircraft more realistic, without any material reduction in safety. Accordingly, section 4b.383 of Part 4b of the Civil Air Regulations is being amended to provide for all-cargo operations the new Class "E" cargo compartment located in the main cabin of an airplane. Such compartment is required to be equipped with a smoke or fire detector system to warn the crew of smoke or fire, to be completely lined with fire-resistant material, to provide for control of ventilation by the crew within the compartment, and to provide means for excluding hazardous quantities of smoke, flames, or noxious gases from entering the flight crew's compartment. Furthermore, it requires that crew-emergency exits remain accessible under all loading conditions.

In conjunction with the establishment of Class "E" cargo compartments, section 4b.380(c) is being amended to provide protective breathing equipment for the crew when the aircraft contains such a compartment. Since the operating record reveals that heat sources in proximity to cargo constitute a fire hazard, section 4b.382 is also being amended to provide fire protection from sources of heat such as light bulbs, heater ducts, electrical appliances, and combustion heaters in all classes of compartments.

In addition to the foregoing, section 4b.383(b), applicable to "B" compartments, is being amended by deleting the requirement that while the aircraft is in flight a member of the crew must be able to move by hand all contents of the compartment. This deletion is considered to be consistent with the requirements for Class "A" and "E" compartments.

Interested persons have been afforded an opportunity to participate in the making of this amendment (24 F.R. 128), and due consideration has been given to all relevant matter presented. Since this amendment is relaxatory in nature and imposes no additional burden on any person, it may be made effective upon publication in the Federal Register.

### Amendment made changes in sections 4b.380, 4b.382, and 4b.383

---

#### Amendment 4b-11

Miscellaneous Amendments Resulting From  
the 1958 Annual Airworthiness Review

Adopted: Aug. 24, 1959  
Effective: Oct. 1, 1959  
Published: Sept. 1, 1959  
(24 F.R. 7067)

There are contained herein amendments as a result of the 1958 Annual Airworthiness Review.

The flight characteristics requirements are being amended to change the provisions relating to longitudinal trim and elevator control power. The currently effective regulations require sufficient elevator control power to fly the airplane at all speeds, powers, weights, and center of gravity positions for which the airplane is to be certificated. Transports of recent design are utilizing adjustable stabilizers and control power becomes a function of the stabilizer incidence setting. The amendments to sections 4b.112(c)(1), 4b.131(a), and 4b.151(a) are intended to make these provisions more appropriate for applications to adjustable stabilizers.

A number of changes to the structural provisions are being made. Section 4b.1 is being amended to include a definition of the term "zero fuel weight" which is frequently used in stating the structural limitations of an airplane. Amendments to sections 4b.210(b)(2), 4b.213(c), and figure 4b-2 are intended to eliminate possible inconsistencies in the relation between design speed  $V_A$  and point A on the maneuvering envelope, which resulted from previous amendments.

A proposal to reduce the required maneuvering load factor at the design dive speed  $V_D$  was considered during the annual airworthiness review but is not being adopted at this time. Although previous operating statistics show that the probability of attaining a 2.5 load factor is less at speed  $V_D$  than it is at lower speeds, there has been relatively little operating experience on turbine transports for which the cruising speed is closer to  $V_D$ . The proposal will be kept under study as operating statistics are obtained on turbine transports.

Section 4b.216(a) is being amended to specify engine torque loads appropriate for turbine engine installations. A new section 4b.217 is being added to specify strength criteria for speed control devices used in flight. Changes to sections 4b.231, 4b.235, and 4b.236 provide more rational ground load requirements relating to coefficients of friction and deflated tire conditions.

A change to section 4b.421(a) requires structural test or analysis of the fuel tanks when subject to pressure developed under the most adverse condition of airplane roll and fuel load. On the basis of past experience, section 4b.421(c) is being revised to require non-metallic tanks to be tested only for the vibration test of section 4b.421(b)(4), since this has been found to be the critical condition, except that compliance may be shown based on satisfactory operating experience with a similar tank in a similar installation.

With respect to design and construction, a number of changes are being made. On some high-speed airplanes, it is likely that control surface dampers will be necessary in order to show compliance with the flutter prevention requirements. Therefore, section 4b.308 is being revised to provide that it shall be possible to continue safe flight even though a single failure occurs in the flutter damper system. Section 4b.320 is being amended to include design safety criteria for power-operated control systems. This amendment is intended to insure continued safe flight and landing in the event certain failures occur in the control system and in the case of engine failure.

Section 4b.352 is being amended to specify which portion of the windshield is affected by the bird impact strength requirements and which portion is affected by the fragmentation requirements.

To provide appropriate emergency exit requirements for small transports section 4b.362(c) is being amended to require at least one type IV exit on each side of the fuselage for a passenger capacity of up to 10 persons. A corresponding change is being made in the ditching exit requirements of section 4b.362(d).

In the powerplant installation requirements, section 4b.407 is being amended to extend the "fail-safe" concept to all types of thrust reversing systems intended for ground and/or inflight use. Sections 4b.410 and 4b.413 are being revised to simplify and clarify the statement of the fuel system and fuel flow requirements. Related changes to section 4b.430 clarify the definitions of main and emergency fuel pumps, delete the requirements that one pump for each engine must be engine driven, and eliminate the requirement for a bypass on fuel injection pumps for turbine engines.

Other amendments require cooling tests for turbine engine installations and means to indicate the functioning of the powerplant ice protection system.

A proposal to require the ability to regain full power or thrust within 20 seconds after engine malfunctioning occurs due to depletion of fuel in any tank was considered during the annual airworthiness review, but is not being adopted at this time. The objective of this proposal was to minimize the possibility of turbine engine flame-out during fuel tank switching. However, since there are several methods of accomplishing this objective, including systems designed to prevent such engine malfunctioning, further study is being given to this subject.

Other proposals being deferred for further study concern turbojet reverse thrust controls, the fire resistance of turbine engine installation diaphragms, and a means to indicate a clogged fuel filter condition (i.e., bypass operation) to the flight crew. The proposal on reverse thrust controls would have deleted the provision requiring a means to prevent inadvertent movement to a reverse thrust position, for systems which are approved for use in flight. Such systems are still in the development stage and additional evaluation is considered necessary to determine whether the previous proposal or some other change is appropriate. The proposal to permit fire-resistant in lieu of fire-proof diaphragms in certain turbine engine installations will be considered along with other changes in the powerplant fire protection requirements to make them suitable for isolated pod installations. The value of inflight indication of fuel filter clogging has been questioned in view of the fact that automatic filter bypass provisions cannot be controlled in flight and the military services are developing devices to indicate the occurrence of bypassing to maintenance personnel who can then service the filters.

Section 4b.603 is being amended to incorporate current terminology for flight and navigational instruments. However, a proposal which would require all critical airspeed limitations that vary with altitude to be displayed on the appropriate instrument is being deferred for further study. Where a number of such limitations exist, that proposal might be impractical or lead to confusion or undesirable differences in displaying airspeed limitations to pilots. At present,  $V_{NE}$  is the only variable limit required to be indicated. A machmeter is being required for airplanes having compressibility limitations which are not otherwise indicated to the pilot in accordance with section 4b.732.

Section 4b.612 is being revised to clarify the power failure indicating means required for certain instruments. Section 4b.625 is being amended to cover new types of storage batteries as well as the conventional lead-acid types. A new section 4b.628 establishes criteria intended to minimize the hazards of lightning strikes on portions of the airplane which are insulated from the main airframe.

Another new section 4b.647 requires all new type transport category airplanes to be provided with individual flotation means for each occupant even though the airplane is not



certificated for ditching. The requirement that life preservers shall be reversible is being deleted from section 4b.645(d), since it is expected that design features and instructions to insure correct donning will be covered in the appropriate Technical Standard Order. Since chunks of ice falling from aircraft have caused hazards to persons and property on the ground, a new section 4b.660 requires that fluid drains be designed to prevent the formation of ice on the airplane. A placard showing the airspeed limitations for various flap settings is being required because these limitations are no longer shown on the airspeed indicator.

Interested persons have been afforded an opportunity to participate in the making of this amendment (24 F.R. 128), and due consideration has been given to all relevant matter presented.

**Amendment made the following changes:**

- (1) Amended sections 4b.1, 4b.112, 4b.131, 4b.151, 4b.210, 4b.213, 4b.216, 4b.231, 4b.235, 4b.236, 4b.308, 4b.320, 4b.352, 4b.362, 4b.407, 4b.410, 4b.413, 4b.415, 4b.421, 4b.430, 4b.461, 4b.483, 4b.603, 4b.612, 4b.613, 4b.625, 4b.632, 4b.645, and 4b.738, and figure 4b-2;
- (2) Deleted sections 4b.414 and 4b.431; and
- (3) Added sections 4b.217, 4b.455, 4b.628, 4b.647, and 4b.660.

---

**Amendment 4b-12**

Miscellaneous Amendments Resulting From  
the First Federal Aviation Agency Air-  
worthiness Review

Adopted: Mar. 27, 1962  
Effective: May 3, 1962  
Published: Mar. 30, 1962  
(27 F.R. 2986)

As a result of the First Federal Aviation Agency Airworthiness Review, the Agency published a notice of proposed rule making affecting several parts of the Civil Air Regulations. This notice was published in the Federal Register (26 F.R. 5130) and circulated as Civil Air Regulations Draft Release No. 61-12 dated June 8, 1961. There are contained herein amendments to Part 4b of the Civil Air Regulations which stem from this First FAA Airworthiness Review.

Interested persons have been afforded an opportunity to express their comments in regard to the proposal. In some cases the proposal has been modified in accordance with such comments. The more significant amendments being adopted by the Agency are discussed herein.

Several revisions to the flight requirements are being made. A change is made to section 4b.160(c)(1) for consistency with the trim condition applicable to the stall speed in present section 4b.112(c)(1). The proposed amendment to section 4b.112, to redefine the stalling speed as the 1g level flight stall speed, is being deferred pending further evaluation of the effect of such a change.

To supplement existing controllability requirements, section 4b.130 is being expanded to provide pilot control force criteria during phases of unsteady flight and during transition from one flight condition to another. The proposal provided, among other things, that both temporary and prolonged forces be considered with the airplane trimmed in the prior steady flight condition. Two significant changes have been made to this proposal. The first change permits compliance to be shown in an untrimmed condition when the airplane cannot be trimmed so as not to encroach upon the requirements of sections 4b.140 through 4b.144. The second change permits retrim during the investigation of the prolonged forces. In conjunction with these changes, the proposed note has been deleted because it does not illustrate the prescribed forces. In addition, section 4b.131 is being amended to prescribe the maximum longitudinal control force applicable to operation with one hand.

A number of changes are being made to the stability requirements. Because static longitudinal stability may become dependent upon the stick-fixed characteristics as well as the stick-free characteristics when artificial stick forces are used, the stability requirements of section 4b.150 through section 4b.155 are being revised. If the elevator control forces are not the result of the elevator control surface hinge moments, it must be shown that an

upward displacement of the elevator trailing edge is necessary to obtain and maintain speeds below the specified trim speed and a downward displacement of the elevator trailing edge is necessary to obtain and maintain speeds above the specified trim speed. Proposed section 4b.151(a), has been changed merely to reflect the new speed nomenclature prescribed by the addition of section 4b.191. Section 4b.151(c), which now requires any speed change to be perceptible to the pilot by a change in stick force, is also being amended. Because of difficulties in ascertaining a "perceptible" change in stick force, the minimum stick force versus speed gradient is being defined as not less than one pound per 6 knots. Present section 4b.155 provides that the airplane be stable over the entire operating speed range under the most adverse trim condition. In many cases this involves very large speed ranges over which it is no longer considered necessary to demonstrate stability without retrimming. While it was originally proposed to permit retrimming at  $V_A$  it has been determined that such a provision would be unnecessarily restrictive and the proposal has been changed to permit retrim at a speed midway in the cruising speed range. However, this change necessitates the addition of a provision to insure stability over an adequate speed range in those cases where the operating speed range is relatively small.

In conjunction with these proposed changes, sections 4b.150-1 and 4b.151-1 are being deleted together with the discussion of policies relating thereto, as well as sections 4b.152-1, 4b.153-1, 4b.154-1, and 4b.155-1 because this material does not reflect the changes being made to the corresponding sections of the regulations and the information contained in these sections is already covered elsewhere. In addition sections 4b.157-1(e)(3), (e)(4), and (f)(2) are being deleted because they are in conflict with the provisions of section 4b.157.

Amendments to the strength requirements include changes to the provisions on flap design speeds, pressure cabins, unsymmetrical loads due to engine failure, ground handling conditions, landing gear fatigue evaluation, and casting factors.

The present requirements on design flap speed  $V_F$  in section 4b.210(b)(1) were based on the concept of a single speed at which the pilot could place the flaps in any position from fully retracted to fully extended without reducing or increasing speed and without exceeding limit loads or without approaching a stalling condition. For this reason the requirements specify that  $V_F$  shall not be less than the greater of  $1.4 V_{s1}$  (flaps retracted) or  $1.8 V_{s0}$  (flaps in landing position). However, the development of more efficient flaps has resulted in the establishment of different operating speeds and flap positions for various stages of flight: e.g., initial approach, final approach, landing, and takeoff. The requirements are being amended to permit supplementary values of the flaps extended operating limit speed (section 4b.714(c)), and to cover en route flap conditions (section 4b.212(b)). Nevertheless, the single flap design speed concept has been retained in sections 4b.210(b), 4b.212(a), 4b.221(a), and 4b.714(a).

Recent improvements in high lift flap design have raised the question of whether it is any longer necessary for the design speed for flaps in the landing position to be based on the stalling speed with flaps retracted. In view of the current operating practice of progressively reducing airspeed as flaps are extended during approach and landing, and of retracting flaps as airspeed increases during takeoff or balked landing, it appears more rational to base the design speed for each flap position on the operating and stalling speeds corresponding with the particular flap position. Therefore, section 4b.210(b)(1) is being amended to permit the selection of a flap design speed for each flap position established for the various stages of flight, with minimum values of  $1.8 V_{s0}$  for flaps in the landing position, and  $1.6 V_{s1}$  for flaps in the takeoff position. Where an automatic flap positioning or load limiting device is employed, it is permissible to use the speeds and flap positions programmed by the device. Related changes are being made to sections 4b.1(d)(10), 4b.212 (a), (b), and (c), 4b.221, and 4b.714 to make these requirements consistent with the method adopted for establishing flap design speeds. In this connection, it was proposed to amend section 4b.323(c) to provide specific speed limits for flap load limiting devices in addition to the existing objective requirement in that section. However, the proposed specific limits are not being adopted because the minimum values required in operation depend upon other characteristics of the particular airplane design, and such characteristics can be evaluated under the provisions of the existing regulation.

The present strength requirements for pressurized cabins state that, where the cabin is separated into compartments by bulkheads or floors, the primary structure shall be designed for the effects of sudden release of pressure in any compartment having external doors or windows. Difficulties have arisen in applying these requirements because primary

structure is not defined and the objectives are not stated clearly. Therefore, section 4b.216 (c)(4) is being amended to state that, under conditions of sudden pressure release, the integrity of the structure supporting flight and ground loads and other structure the failure of which could interfere with the continued safe flight and landing of the aircraft, shall be maintained. Damage to other portions of the airplane is acceptable, provided reasonable design precautions are taken to minimize the probability of parts becoming detached which might injure occupants while in their seats. Fail-safe design features may be taken into account, provided possible operational and maintenance errors are also considered.

Section 4b.216(d) presently contains a general requirement that the airplane be designed for the unsymmetrical loads resulting from failure of one engine; e.g., yaw loads due to windmilling drag of a turbopropeller engine. On the basis of experience gained in design evaluation, testing, and operation of turbopropeller airplanes, section 4b.216(d) is being amended to state the factors to be considered in determining these loads, including types of engine failure, corresponding airplane speeds, malfunctioning of propeller drag limiting systems, and pilot corrective action.

Section 4b.235 presently contains an inconsistency between the drag loads specified for the main landing gear in the braked roll condition (which may be based on the maximum obtainable brake torque), and the drag load specified for one main gear in the nose wheel yawing condition (which is based solely on a friction coefficient of 0.8). Changes to section 4b.235 are being made which apply the yawing loads resulting from the 0.8 coefficient to the nose gear and supporting structure only. A drag load corresponding with the basic braked roll condition is being applied to one main gear as an overall airplane design condition.

The fatigue evaluation requirements of section 4b.270 at present apply only to structure supporting flight loads. A number of cases of landing gear fatigue cracking or failure have been reported. Although these failures have not resulted in fatal accidents, the possibility of fire after landing gear failure is a potential hazard. Therefore, a new section 4b.271 is being adopted, requiring a fatigue evaluation of the landing gear structure, and, where such evaluation indicates a need, the establishment of inspection or other procedures to prevent catastrophic fatigue failure. Alternatively, it may be shown that catastrophic failure of the landing gear is not probable after fatigue failure or after obvious partial failure of a single structural element.

The present requirements on factors of safety and inspections for structural castings (section 4b.307(a)) specify a special factor of 2.0 for visual inspection only, and a factor of 1.25 when radiographic inspection and strength tests of 3 sample castings are employed. Section 4b.307(a) is being amended to provide a series of casting factors and corresponding test and inspection requirements which reflect current methods and practices. In addition, a minor revision in the format of section 4b.307(a) as proposed is being made and, in the light of comment received, alternative methods of compliance with the proposed requirements of this section are being added.

A revision to section 4b.334(e) concerning landing gear position indicators and warning devices is being made to insure warning in the event a landing is made with one or more throttles advanced. A note is also being added setting forth an acceptance means of compliance which would replace section 4b.334-2. To insure that essential equipment in wheel wells is not damaged by loose tire treads or a bursting tire, a provision is being added which requires protection of such equipment. As a result of comments made on the proposal, alternatives are being added to the requirement, to permit a finding that a tire cannot burst from overheat or that a loose tire tread cannot cause damage. It is intended that such findings will be based on the use of a wheel which is fitted with a fusible plug and a tubeless tire or that an extended wheel is located so that a tire tread which has separated from the wheel cannot enter the wheel well and that the wheel is braked to a stop before retraction into the wheel well.

Current provisions of section 4b.352 do not require fail-safe windshields and windows on pressurized cabin airplanes; however, existing turbine transport airplanes incorporate this feature, which has prevented complete loss of cabin pressurization in a considerable number of partial windshield failure incidents. Therefore, section 4b.352(d) is being amended to require that windshields and window panels in pressurized cabins have strength to withstand the maximum differential pressure load, aerodynamic pressures, and temperature effects after failure of a single element. This amendment differs from that proposed in that it is less restrictive as to the type of window or windshield required.

Sections 4b.357 and 4b.371(d) require that, when louvres or other ventilating devices are provided between cabin partitions, it shall be possible for the crew to stop the flow of air through such ventilating devices. Because this requirement does not accomplish its apparent objective which is covered elsewhere, sections 4b.357 and 4b.371(d) are being deleted.

Sections 4b.358(c)(2) and 4b.643 presently require an additional factor of safety of 1.33 on the loads for seat and safety belt attachments, and section 4b.307(c) requires a factor of 1.15 for structural fittings (attachments). Sections 4b.358(c)(2) and 4b.643 are being clarified by inserting a statement that the 1.33 factor may be applied in lieu of the 1.15 factor, not be added to it. This is consistent with the general principle that only the highest factor intended for a similar purpose need be applied. However, if castings are used, the casting factor specified in section 4b.307(a) still applies, since this factor is intended for another purpose.

The upper aisle width specified in section 4b.362(h) has been reduced from 20 to 18 inches, for airplanes having a passenger seating capacity of 10 or less, on the basis of studies indicating that this reduction would not adversely affect safe emergency evacuation. However, a further reduction of this dimension to 16 inches, as suggested by several interested persons, has not been justified. Biometric data derived from a general sampling of the civilian population reveals that a significant percentage of passengers have a standing hip-breadth exceeding 16 inches, whereas the percentage exceeding 18 inches is negligible. A 16-inch upper aisle width, therefore, introduces the probability that a single passenger may jam the aisle between seats in the excitement and near-panic of an emergency evacuation; and, in any event, movement along the aisle would be retarded by the awkward side-ward gait which large-hipped passengers must assume for passage.

It had been proposed that the optional provision of section 4b.385, which permits the control of fire once it has started, would be deleted. Comments made on that proposal have led to the conclusion that such an amendment might be unnecessarily restrictive and would not be compatible with other requirements which do permit the control of fire in cargo compartments and nacelles. Accordingly, presently effective section 4b.385 remains unchanged. Section 4b.412 dealing with pressure crossfeed lines is being deleted because sections 4b.370 and 4b.385 cover both the fire control and ventilation aspects of section 4b.412.

As a result of comments received, the specific provisions regarding demonstrations or tests are being deleted from sections 4b.413 and 4b.416 as they were proposed in the draft release. Adequate authority for any ground or flight tests which might be required continues to rest in presently effective sections 4b.15 and 4b.16. The flight conditions specified in section 4b.416, used in connection with the selection of unusable fuel supply, are unnecessary if compliance with general fuel flow requirements is obtained and are, therefore, being deleted. The provisions of paragraph (b) of section 4b.416, as proposed in the draft release are being transferred to a new paragraph (c) under section 4b.413, as an editorial change, since the provision for fuel feed belongs more appropriately in the fuel flow section than in the unusable fuel supply section. Presently effective section 4b.415 also covers fuel flow rate, relative to transfer systems and bases required flow rates on horsepower output. Since the changes being made to section 4b.413 eliminate the horsepower basis for establishing flow rate, section 4b.415 is being deleted.

Because of the change made to section 4b.416, material contained in other sections is no longer necessary. Therefore, sections 4b.416-1, 4b.416-2, 4b.418(a), 4b.418-1, and 4b.426-1 are being deleted. Section 4b.420(d) is also being deleted to eliminate a conflict with the definition of unusable fuel supply in section 4b.416.

In addition to the matter of unusable fuel supply, another question has arisen relating to the flow requirements of section 4b.413. Section 4b.413(a) presently requires that the available fuel flow shall be not less than 125 percent of that needed to develop maximum engine horsepower or thrust. The 25 percent margin is not required to insure adequate fuel flow. Furthermore, a margin is unnecessary to offset system deterioration because such deterioration is precluded by proper maintenance, inspection, and overhaul. Section 4b.413 is being amended as proposed in accordance with the foregoing.

Section 4b.436, dealing with fuel system drains, is being revised to delete redundant and contradictory requirements.

Presently effective sections 4b.450 through 4b.455 deal with the powerplant cooling capability and specify test to show that powerplant temperature limits can be maintained. With the exception of section 4b.455, these sections apply to reciprocating engines. Sections 4b.450 through 4b.452 are being clarified by making them generally applicable to turbine engine installations as well as reciprocating engine installations and by specifying test

conditions in general terms which are based on the applicable airplane performance requirements. This clarification makes sections 4b.453 and 4b.455 unnecessary. Accordingly, they are being deleted.

Consistent with the proposed changes to the powerplant cooling requirements, sections 4b.440(e), 4b.440-1, 4b.450-1, 4b.452-1, 4b.453-1, 4b.454-1, 4b.465, and 4b.465-1 are being deleted inasmuch as the matter of oil cooling and carburetor air cooling is covered in the changes being made to sections 4b.450 through 4b.455.

Section 4b.488 requires a fireproof diaphragm to isolate the engine power section and all portions of the exhaust system from the engine accessory compartment, unless equivalent protection can be shown by other means. Fire extinguishing systems are required in all cases to be provided in the engine power section, in the engine accessory section, and in complete powerplant compartments. Since it is considered that fire extinguishing systems are equivalent to a diaphragm in providing protection, there is no reason for retaining the provisions of section 4b.488. Accordingly, this section is being deleted. Consistent with this deletion, editorial changes are being made in sections 4b.484 and 4b.487.

Section 4b.604(q) requires a thrust indicator for each turbojet engine. Because such indicators have not been perfected and because the thrust output information which is desired can be otherwise obtained, this section is being amended to require instead an indicator which will permit the pilot to determine if the thrust of any engine has changed as a result of any engine deficiency. A comment on this section as proposed expressed concern that the proposed phrase "relative to the thrust being obtained by the remaining engines" meant a requirement for a differential thrust indicator between any two engines. Such a meaning was not intended. To prevent the possibility of further misconstrual, the phrase is being deleted. Another comment expressed concern that since pressure ratio indication has been accepted as meeting the requirement for a thrust indicator, it would necessarily be disallowed in meeting a requirement for indication that thrust has changed. A pressure ratio indicator will continue to be acceptable in meeting the amended requirement if it has previously been acceptable in meeting the requirement for a thrust indicator. Since pressure ratio indication might not in all cases fully satisfy the provision that the indicated thrust change results from any engine deficiency, an alternative is being added to the requirement. The alternative will permit the indication of any gas stream pressure which can be related to the thrust output of the engine.

Section 4b.622(b) is being amended by adding two provisions which relate to the proper functioning of the generating system with respect to load equipment. These provisions are a more precise statement of the requirement in currently effective section 4b.627 and permit deletion of that requirement.

To eliminate an unnecessarily restrictive provision requiring that certain electrical protective devices or their controls be accessible for resetting in flight, section 4b.624(d) is being amended. Section 4b.627 is also being amended by deleting the currently effective rule and adding several provisions to insure the validity of electrical system tests under simulated conditions in the laboratory. The wording in the present section is being deleted because: (1) Other sections require such tests as are necessary to show compliance with all airworthiness requirements, including those dealing with the electrical system; and (2) the need for the provision that the electrical system "functions properly and without electrical or thermal distress" has been eliminated by the revision to section 4b.622(b).

Presently effective section 4b.652 deals with the reliability of engine-driven accessories and section 4b.659 specifies that an airplane must be able to continue safe flight in the event of a failure of a high energy rotor. These two sections are being deleted because their substance is covered by the provisions of section 4b.606 which is concerned with the reliability of all equipment, systems, and installations.

Hydraulic system service difficulties have arisen which affect the proposal to add a new section 4b.656, concerning hydraulic system tests. Therefore, the proposed addition of section 4b.656, containing a new test requirement, is not being included at this time. A study of the matter is being made outside the framework of this review.

A change is being made to figure 4b-19 dealing with position light intensities in order to remove an irrational discontinuity.

Operating records show an increasing number of cases of exceeding the air-speed operating limits on transport category airplanes, particularly on turbine-powered airplanes. Also, the present regulations lack definite criteria for the rational determination of speed margins. Among the probable causes of overspeed are the characteristics of turbine-powered airplanes which make it desirable to operate at the limit speed, the somewhat indefinite significance of

the present normal operating limit speed, and the increasing preoccupation of pilots with air traffic and other duties which distract them from continuous monitoring of airspeed instruments. Therefore, a series of amendments to the airspeed operating limitations and related requirements are being made. These amendments replace the existing normal operating limit and never exceed speeds (sections 4b.711 and 4b.712) by a single speed at the previous normal operating limit value. The new single limit is designated as the "maximum operating limit speed," and is defined in the Airplane Flight Manual (section 4b.741) as a speed which shall not be deliberately exceeded in any regime of flight, except where a higher speed is authorized for flight test or pilot training operations. The amendments provide a rational method (based on a 7.5 degree dive maneuver), as well as alternative arbitrary factors, for calculating the speed margin between the new limit speed and the demonstrated flight or structural dive speeds. To provide for atmospheric conditions and other operational factors not covered by the 7.5 degree dive criteria, the amendments include a minimum speed margin of 0.05 Mach number beyond the operating limit speed. This is 0.04 M beyond the aural warning speed, and is believed to be consistent with the minimum margin on existing airplanes.

A new section 4b.191, high-speed characteristics, is being adopted to cover in general terms the flight tests for speed increase and recovery characteristics, and to establish a maximum speed  $V_{PC}$  for certain stability characteristics. The speed margin between design speeds  $V_C$  and  $V_D$  in section 4b.210 is being replaced by a cross reference to section 4b.711.

To minimize overspeeding due to pilot preoccupation, section 4b.603 is being amended by adding a new paragraph (k) to require an aural warning device on turbine-powered airplanes and on other airplanes having a speed margin of less than 20 percent between limit and demonstrated speeds. To insure early warning and thus to make a major portion of the speed margin available for pilot reaction and recovery maneuvers, the amendment also requires that the warning occur whenever the speed exceeds the limit speed by more than 6 knots or 0.01 M.

The changes in terminology in the air-speed limitations require corresponding changes, including deletions and additions in sections 4b.1(d) (9), (15), and (16); 4b.132(e); 4b.141; 4b.142(c); 4b.155; 4b.156; 4b.157; 4b.157-1; 4b.158; 4b.210(b)(4); 4b.210(b)(5); 4b.484-1 (b)(1); 4b.603(a); 4b.612(a)(3); 4b.612-4(a); 4b.711; 4b.712; 4b.740-1; and 4b.741(a).

Miscellaneous changes of an editorial or clarifying nature are being made to sections 4b.1, 4b.11, 4b.155, 4b.160, 4b.221, 4b.306, 4b.306-1, 4b.329-2, 4b.329-6, 4b.435, 4b.447, 4b.612, 4b.642, 4b.645, 4b.718, and 4b.738. Among the miscellaneous amendments there is one to expressly exclude from the provisions of section 4b.11(b) consideration of provisional type certificates. While it was proposed that this be accomplished by a note, it now appears that it is more appropriate to include such a provision within section 4b.11(b) rather than as a note thereto. Furthermore, the proposed section 4b.612(f)(4) requiring two complete static air pressure operating systems for the required instruments at the first pilot's station has been withdrawn in the light of comment received. It has been determined that one such static air pressure operating system as presently required is all that is necessary as a minimum requirement in the interest of safety.

Interested persons have been afforded an opportunity to participate in the making of this amendment, and due consideration has been given to all relevant matter presented.

**Amendment made the following changes:**

- (1) Amended sections 4b.1, 4b.11, 4b.130, 4b.131, 4b.132, 4b.141, 4b.142, 4b.150, 4b.151, 4b.152, 4b.153, 4b.154, 4b.155, 4b.156, 4b.157, 4b.157-1, 4b.158, 4b.160, 4b.210, 4b.212, 4b.216, 4b.221, 4b.235, 4b.270, 4b.306, 4b.306-1, 4b.307, 4b.329-2, 4b.329-6, 4b.334, 4b.352, 4b.358, 4b.362, 4b.371, 4b.413, 4b.416, 4b.418, 4b.420, 4b.435, 4b.436, 4b.440, 4b.447, 4b.450, 4b.451, 4b.452, 4b.484, 4b.484-1, 4b.487, 4b.603, 4b.604, 4b.612, 4b.612-4, 4b.622, 4b.624, 4b.627, 4b.642, 4b.643, 4b.645, 4b.711, 4b.714, 4b.718, 4b.730, 4b.740-1, and 4b.741, and figure 4b-19;
- (2) Deleted sections 4b.150-1, 4b.151-1, 4b.152-1, 4b.153-1, 4b.154-1, 4b.155-1, 4b.357, 4b.412, 4b.415, 4b.416-1, 4b.416-2, 4b.418-1, 4b.426-1, 4b.440-1, 4b.450-1, 4b.452-1, 4b.453, 4b.453-1, 4b.454-1, 4b.455, 4b.465, 4b.465-1, 4b.488, 4b.652, 4b.659, and 4b.712; and
- (3) Added sections 4b.191 and 4b.271.

## Amendment 4b-13

Turboprop Conversions of Transport  
Category Airplanes

Adopted: December 20, 1962  
Effective: December 20, 1962  
Published: December 29, 1962  
(27 F.R. 12925)

Special Civil Air Regulation No. SR-423 effective December 20, 1957, terminates on December 20, 1962. The purpose of this amendment to Part 4b is to incorporate the substance of SR-423 permanently into the Civil Air Regulations. SR-423 permits the type certification of turboprop airplanes, which previously were type certificated with the same number of reciprocating engines, without requiring compliance with all of the applicable requirements of the Civil Air Regulations effective on the date of application for the type certificate for the turboprop version. This amendment affects applicants for a type certificate for a turboprop conversion.

Section 4b.11(e) of Part 4b of the Civil Air Regulations provides that a change to engines employing different principles of operation or propulsion requires the issuance of a new type certificate based upon compliance with the regulations, together with all amendments thereto, effective on the date of the new application. A change from reciprocating engines to turboprop engines is a change to engines employing different principles of operation. Compliance with all the latest requirements of Part 4b would therefore be required for the type certification of a turbopropeller-powered transport category airplane previously certificated with the same number of reciprocating engines. Based, however, upon the belief that compliance with the latest requirements of Part 4b for such airplanes might be burdensome, impractical and not essential to safety, SR-423 was adopted in December of 1957 as a relaxation of the requirements of Part 4b. SR-423 permits the certification of turbopropeller-powered airplanes upon the showing of compliance with the airworthiness provisions applicable to the airplane as type certificated with reciprocating engines, together with certain later provisions of the Civil Air Regulations in effect on the date of application for a new or supplemental type certificate which are applicable or related to the powerplant of the turbopropeller-powered version. In addition, under the provisions of SR-423, transport category airplanes with turboprop replacements are required to comply with only the certification performance requirements of SR-423.

By its own terms, SR-423 terminates on December 20, 1962. The preamble to that regulation states, however, that at the end of its period of effectiveness the regulation would be evaluated for the purpose of considering the incorporation of the substance of its rules in the permanent body of the Civil Air Regulations. In this connection, the Federal Aviation Agency is aware that there is a continuing interest within the industry in the installation of turbopropeller-powered engines on airplanes presently equipped with reciprocating engines and that compliance with the latest provisions of Part 4b for such installation would be burdensome. Furthermore, experience has shown that the provisions of SR-423 provide an adequate level of safety for the airplanes certificated thereunder and that compliance with all of the latest requirements of Part 4b is not essential in the interest of safety for the certification of transport category airplanes with turboprop replacements. The Agency believes, therefore, that the substance of the provisions of SR-423 should be incorporated permanently into the Civil Air Regulations.

In order to accomplish the foregoing, section 4b.11(e)(2) is amended by deleting the words "operation or". Thus the provisions of that section are made applicable only to a change to engines employing different principles of propulsion. Since reciprocating and turboprop engines employ the same principles of propulsion, airplanes involving a conversion from reciprocating to the same number of turboprop engines will not be affected by the requirement for a new type certificate. Furthermore, to make the provisions presently set forth in SR-423 explicitly applicable to such airplanes, they are being incorporated into a new paragraph (f) under section 4b.11.

Consistent with the provisions of SR-423, this amendment requires that turboprop airplanes which were previously type certificated with the same number of reciprocating engines shall comply only with the certification performance requirements prescribed in Special Civil Air Regulation SR-422B. Therefore, a concurrent amendment is being made to SR-422B to limit the applicability of that regulation, with respect to turboprop airplanes which were previously type certificated with the same number of reciprocating engines, to compliance with the certification performance requirements set forth therein.

Since this amendment extends the provisions of a current regulation, and imposes no additional burden upon any person, compliance with the notice and public procedure provisions of the Administrative Procedure Act is unnecessary, and good cause exists for making it effective on less than 30 days' notice.

Amendment revised section 4b.11 by deleting the words "operation or" from paragraph (e)(2), and by adding a new paragraph (f).

---

(Rev. 2/1/63)